



Roborock Robot Vacuum Cleaner S5 Max User Manual

Read this user manual carefully before using this product and store it properly for future reference.

Roborock Robot Vacuum Cleaner S5 Max User Manual	1
Read this user manual carefully before using this product and store it properly for future reference.	
Manuel d'utilisation du robot aspirateur Roborock série S5 Max	38
Avant d'utiliser ce produit, lisez attentivement le présent manuel et rangez-le soigneusement pour pouvoir le retrouver en cas de besoin.	
Benutzerhandbuch für den Roborock Staubsaugerroboter der S5 Max-Reihe	75
Lesen Sie dieses Benutzerhandbuch vor der Verwendung dieses Produkts sorgfältig durch und bewahren Sie es zum späteren Gebrauch auf.	
Manuale utente del robot aspirapolvere Roborock serie S5 Max	112
Leggere attentamente questo manuale utente prima di utilizzare questo prodotto e conservarlo adeguatamente per riferimenti futuri.	
Manual de usuario del robot aspirador Roborock serie S5 Max	149
Lea atentamente este manual del usuario antes de utilizar este producto y guárdelo adecuadamente para futuras consultas.	

• Safety Information	1
• Table of Faults	5
• Welcome	6
• Product Introduction	7
• Installation	12
• Instructions for Use	18
• Routine Maintenance	21
• Environmental protection description	26
• Basic Parameters	27
• Troubleshooting	28
• FAQs	30
• EU Declaration of Conformity	31
• WEEE Information	35
• Warranty Information	36

Safety Information

Restrictions

- This product is designed for indoor floor cleaning only, do not use it outdoors (such as on an open-ended terrace), on any surface other than the ground (such as a sofa), or in any commercial or industrial environment.
- Do not use this product on elevated surfaces without barriers such as the floor of a loft, an open-ended terrace, or on top of furniture.
- Do not use the product when the ambient temperature is higher than 104°F (40°C), lower than 39°F (4°C), or if there are liquids or tacky substances on the floor.
- Before using the product, move wires off the ground or place them to the side to prevent them being pulled on by the cleaner.
- To prevent blocking the product and to avoid damage to valuables, remove lightweight items (such as plastic bags) and fragile objects (such as vases) from the floor before cleaning.
- Children should be supervised to ensure that they do not play with the appliance.
- This product is not intended for use by persons (including children) with reduced physical, sensory or mental capabilities, or lack of experience and knowledge, unless they have been given supervision or instruction concerning use of the product by a person responsible for their safety (CB).
- This product can be used by children aged from 8 years and above and persons

Safety Information

with reduced physical, sensory or mental capabilities or lack of experience and knowledge if they have been given supervision or instruction concerning use of the product in a safe way and understand the hazards involved. Children shall not play with the product. Cleaning and user maintenance shall not be made by children without supervision (EU).

- Keep the main brush cleaning tools out of reach of children.
- Do not place any object (including children and pets) on the product, whether it is in operation or not.
- Keep hair, loose clothing, fingers, and all parts of the body away from openings and moving parts.
- Do not use the product on burning objects (such as cigarette butts).
- Do not use the product on high pile carpets (product effectiveness may also be reduced on dark carpets).
- Do not use the product to clean hard or sharp objects (such as decoration wastes, glass and nails).
- Do not carry the product using the laser scanner cap, main unit cover, or collision buffer.
- The product must be switched off and the plug must be removed from socket-outlet before cleaning or maintaining the product.

Safety Information

- Do not use wet cloth or liquids for cleaning the product.
- Do not use the mopping module on carpets.
- Use the product according to the manual. Any loss or damage caused from improper use will be borne by the user.
- This product contains batteries that are only replaceable by skilled persons.

Battery and Charging

WARNING

- Do not charge non-rechargeable batteries.
- For the purposes of recharging the battery, only use the detachable supply unit roborock CDZ11RR or CDZ12RR provided with this product.
- Do not dismantle, repair or modify the battery or charging dock.
- Keep the charging dock away from heat (such as heating vents).
- The battery must be removed from the appliance before it is scrapped.
- The product must be disconnected from the supply mains when removing the battery.
- The battery must be disposed of safely. Do not discard waste batteries. Leave them with a professional recycling organization.
- Do not wipe or clean the charger prongs with wet cloth or wet hands.

Safety Information

- If the power cord is damaged, stop using it immediately. It must be replaced by the manufacturer, its service agent, or similarly qualified persons to avoid a hazard.
- Make sure the product is powered off before shipment.
- Use of the original packaging is advised.
- If to be left unused for a long period of time, fully charge the product and switch it off before storing it in a cool, dry place.
- Charge it at least every three months to avoid over discharging the battery.
- To satisfy RF exposure requirements, a separation distance of 20 cm or more should be maintained between this device and persons during device operation.
- To ensure compliance, operations at closer than this distance is not recommended.
- The antenna used for this transmitter must not be co-located in conjunction with any other antenna or transmitter.

Table of Faults

Table of Faults	
Item	Fault
Main Unit	Functions do not work.
	Does not power on.
	Main brush, side brush, fan or main wheel issue.
Charging dock	Main unit does not charge.
Power cable	Charging dock has no power.

Welcome

Thank you for choosing a Roborock Robot Vacuum Cleaner.

Treat yourself to crisp, just-mopped floors every day with S5 Max. Engineered for a seamless automated mopping, it has a super-sized water tank, precision water control, virtual no-mop zones, and more. Combined with precision laser mapping, advanced navigation, and intense vacuum suction, it makes spotless floors easier than ever. All you need to do is set it and get on with living.

Roborock is committed to putting advanced technologies to work for you, so that you can waste less time on chores and do more of the things you love.

Product introduction

Robot

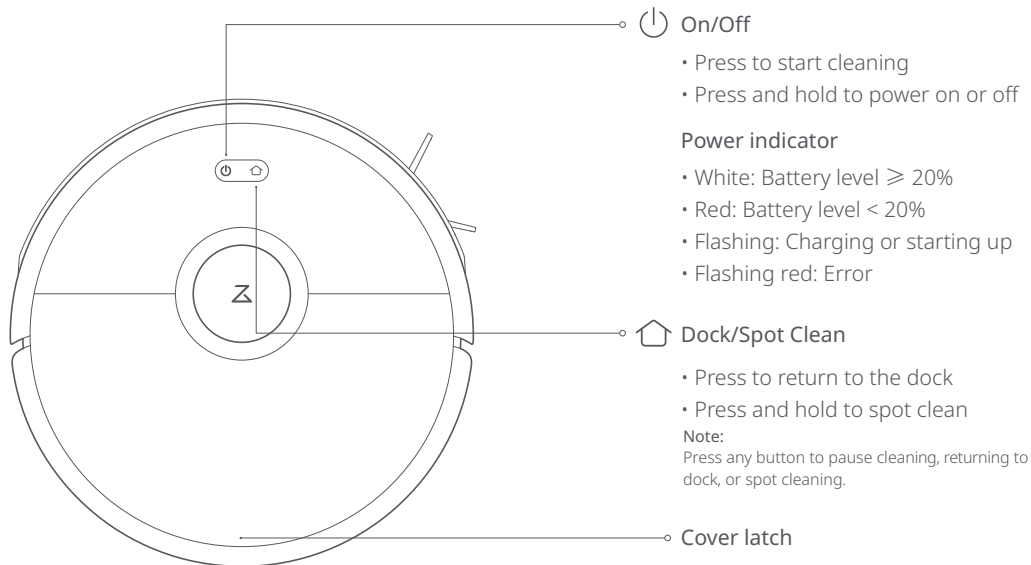

Product introduction

Parts list

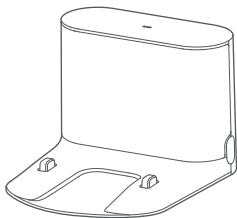

Charging dock

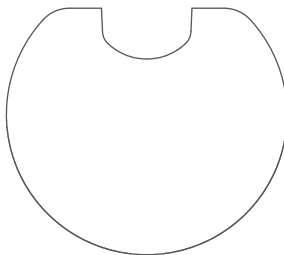

Moisture-proof mat

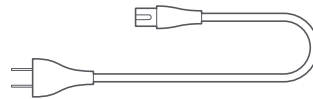

Power cable

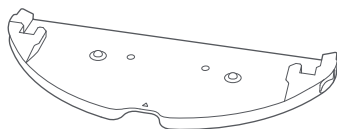

Mop cloth mount



Mop cloth

Product introduction

Dustbin

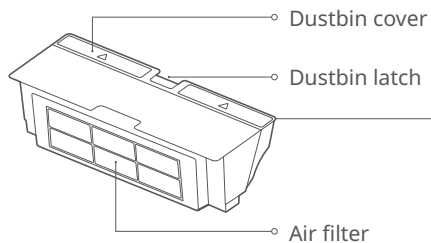

Robot

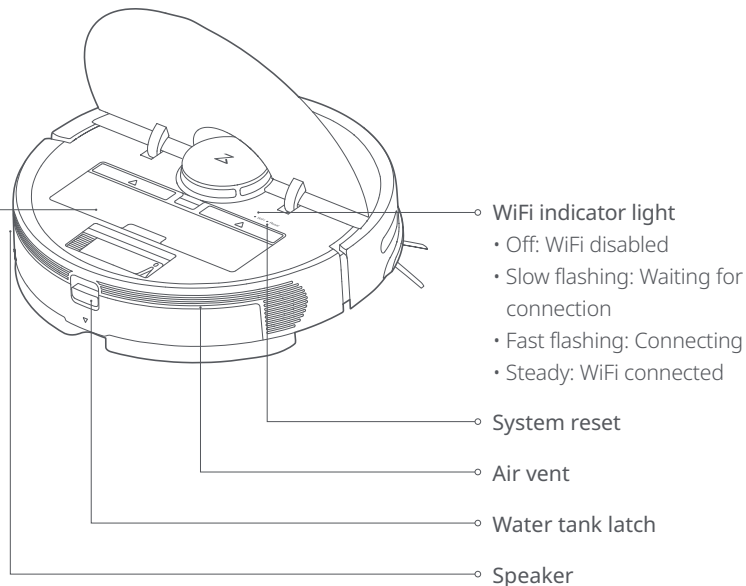

Product introduction

Machine and sensors

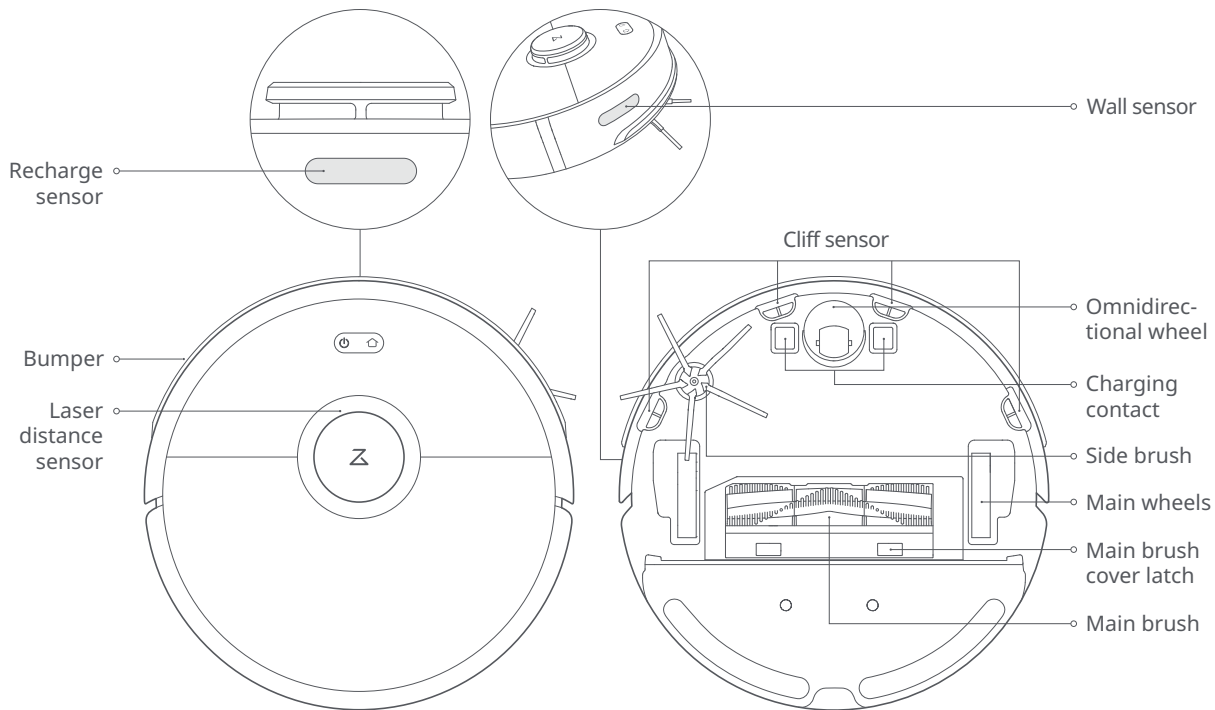

Product introduction

Mopping module

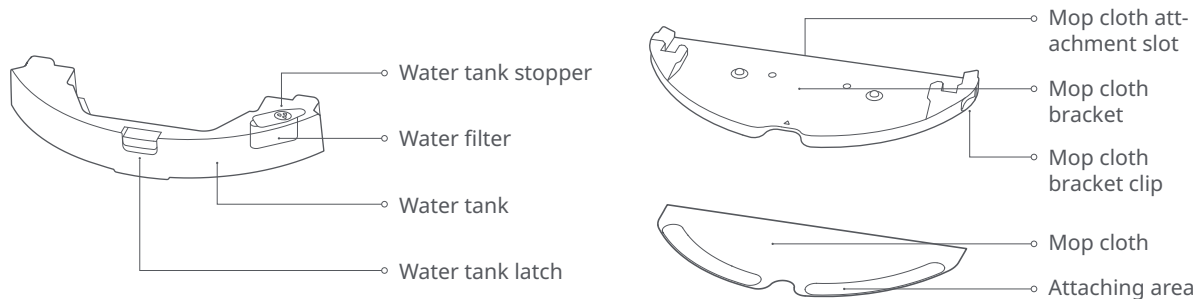

Charging dock

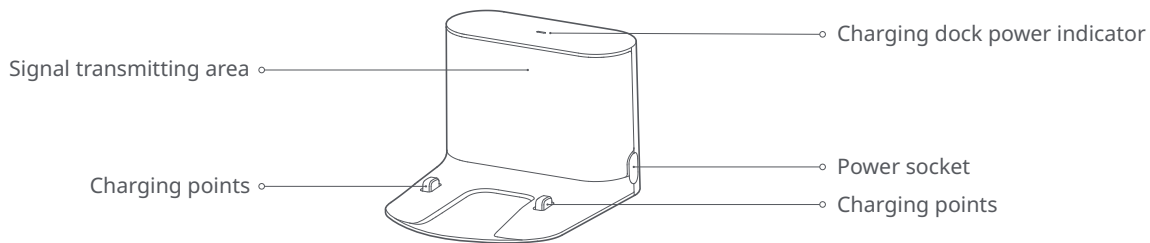

Installation

Using the robot

1. Place the charging dock against the wall on a flat surface and plug it into the mains power.

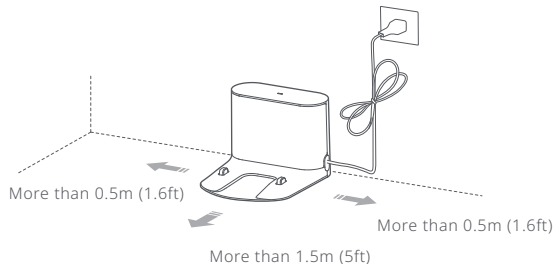

Note:

- The charging dock should have more than 0.5m (1.6ft) of clearance on each side, and more than 1.5m (5ft) in the front.
- If the power cable is vertical to the ground, it may be caught by the machine, causing the charging dock to be disconnected.
- The charging dock indicator is on when the charging dock is electrified, and off when the robot is charging.

2. Secure the charging dock with the adhesive tape.

Wipe the floor of the area where the charging dock will be placed with a dry cloth, then stick the enclosed double-sided tape to the floor. Place the dock onto the double-sided tape to secure it in place.

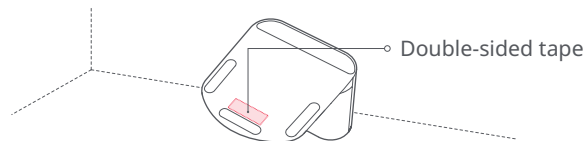

Note

- Use of the double-sided tape to secure the charging dock is optional.
- When necessary, remove the double-sided adhesive tape slowly to reduce residue glue.

Installation

Using the robot

3. Secure the moisture-proof mat.

After securing the charging dock, wipe the area where the moisture-proof mat will be placed with a dry cloth as shown. Stick the double-sided tape first to the moisture-proof mat then in position on the floor.

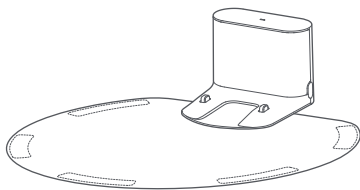

Note:
Always place the moisture-proof mat on a wooden floor

4. Power on and charge.

Press and hold the  button to turn on the robot. When the power indicator lights up, place the robot onto the charging dock to begin charging. The robot uses a high-performance lithium-ion rechargeable battery. To maintain peak battery performance, always keep the robot charged.

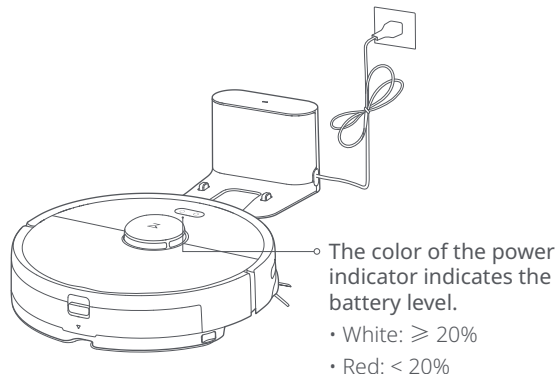

Note:
The robot will not turn on when the battery is low. Place the robot directly onto the charging dock to begin charging.

Installation

Connect to the app

5.Connect to the app.(recommended)

①Download the Roborock app or Xiaomi home app

a. Search "Roborock" in the App Store or Google Play, Or scan the QR code below, then download and install the app.





b. Search "Xiaomi home" in the App Store or Google Play, Or scan the QR code below, then download and install the app.



② Reset WiFi

a. Open the top cover of the robot to reveal the WiFi indicator light.

b. Press and hold the  button and the  button until you hear the "Reset WiFi" voice alert. When the WiFi indicator light is flashing slowly, the robot has entered network configuration mode.

Note:

If you cannot connect your phone to the robot, reset the WiFi, and add your robot as a new device.

③ Add device

Open the app and click "+" in the top right corner, then follow the instructions in-app. Once your robot has been added, it will be found in a list on the homepage.

Note:

- Due to ongoing app development, the actual process may differ slightly from the above description. Always follow the instructions given in the app.
- Only 2.4GHz WiFi is supported.

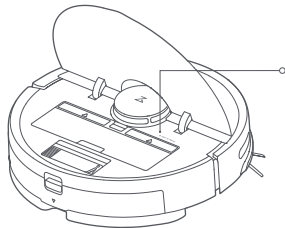

WiFi indicator light

- Off: WiFi disabled
- Slow flashing: Waiting for connection
- Fast flashing: Connecting
- Steady: WiFi connected

Installation

Using the robot

6. Mopping

Note:

It is recommended that all floors are vacuumed at least three times before the first mopping session to reduce excessive dirt buildup on the mop.

① Remove the water tank

Press down the water tank latch and slide the tank backwards to remove it.

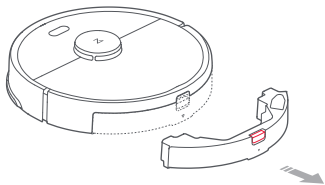

② Fill the water tank

Open the water tank, fill it with water, and close it tightly.

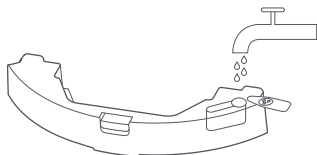

Note:

- To prevent corrosion or damage, do not use cleaning fluid or disinfectant in the water tank.
- Do not use hot water, which may cause the tank to deform.

③ Install the water tank

Slide the water tank into the robot until you hear it lock with a click.

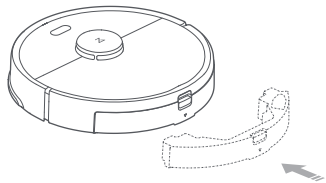

④ Install the mop cloth

If mopping immediately, dampen the mop cloth and squeeze it dry then attach it to the mop cloth bracket.

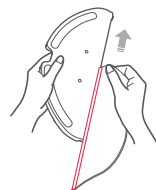

Note:

Use a barrier tape or no-mop zones to separate prevent mopping on carpeted floors.

Installation

Using the robot

5. Attach the mop cloth bracket

Slide the mop cloth bracket under the water tank following the alignment marks, until you hear a click.

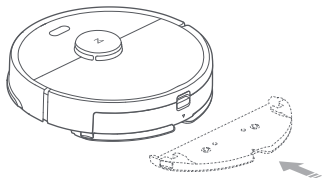

Note:

Cleaning the mop cloth after 60-minutes of mopping is recommended to ensure water flow and cleaning quality.

7. Adjust water flow rate

Use the mobile app to adjust the water flow as required.



8. Start cleaning

When the battery is fully charged, the power indicator will remain lit. Press the  button or use the app to start cleanup.

9. Remove the mop cloth bracket

To remove the mop cloth bracket, press the two clips inwards and pull the bracket backwards.

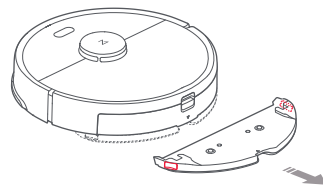

Note:

- When the charging dock is placed on a wooden floor, always use it with the moisture-proof mat to prevent moisture damage.
- Removing and washing the mop cloth bracket, and emptying the water tank frequently is recommended to prevent odors or mildew.
- Remove the mop cloth bracket if not mopping.

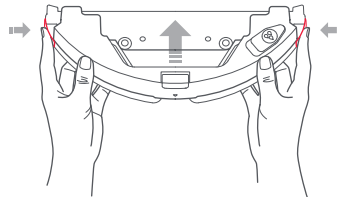

10. Separating the water tank from the mop cloth bracket

As shown in the figure, press the two side clips inwards and slide the mop cloth bracket backwards to separate it from the water tank.



Installation

On/Off

Press and hold the  button to turn on the robot. The power indicator will turn on and the robot will enter Standby mode. If the robot is in Sleep mode, press and hold the  button to turn it off and end the current cleanup.

Note:

The robot cannot be turned off when it is charging.

Start cleanup

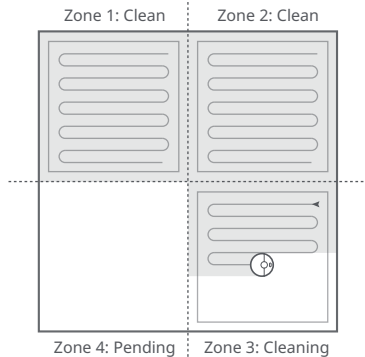

Press the  button to start cleaning. Once started, the robot will plan its cleaning route based on its scan of the area. It cleans along the edges of a zone first and then moves in a Z-shaped cleaning route to cover the internal area efficiently and thoroughly.



Note:

- Cleaning cannot start if the battery level is too low. Allow the robot to charge before restarting cleanup.
- Tidy away any cables on the ground (including the power cable of the charging dock) before cleaning to avoid losing power or damaging either the robot or the connected device.
- If a cleanup finishes within 10 minutes, cleaning repeats by default
- If the battery runs low before cleanup is complete, the robot will carry out a top-up charge before resuming cleanup from where it left off.

Pause

When the robot is cleaning, press any button to pause it. Then press the  button to continue cleaning or the  button to return it to the charging dock and stop the cleaning cycle.

Note:

Placing a paused robot on the charging dock manually will end the current cleanup.

Sleep

If the robot is paused for over 10-minutes, it will go to sleep, and its power indicator will flash slowly. Press any button to wake it back up.

Note:

- The robot will not go to sleep when it is on the charging dock.
- The robot will automatically shut down if left in sleep mode for more than 12 hours.

Instructions for use

Charging

Auto: After cleaning, the robot will automatically return to the charging dock to recharge.

Manual: In Pause mode, press the ⏸ button to send the robot back to the charging dock.

The power indicator will flash slowly as the robot charges.

Note:

If the cleaning cycle was started away from the charging dock and the robot could not return to the dock after cleaning, it will instead return to its starting point. Place the robot directly on the dock to recharge it.

Error

If an error occurs while the robot is cleaning, the power indicator will flash red quickly, and you will hear a voice alert. See "Troubleshooting" for resolution options.

Note:

- The robot will go to sleep automatically if left in an Error state for over 10-minutes.
- Placing the robot on the charging dock in an error state will stop the current cleanup.

Reset WiFi

If your phone cannot connect to the robot because you have changed your router configuration, forgotten your password, or any other reason, open the top cover to see the WiFi indicator light then press and hold the ⏸ button and the ⏻ button until you hear the "Resetting WiFi" voice alert. When the WiFi indicator light flashes slowly, reset is complete.

Note:

If the robot is left connecting to the network for over an hour, its WiFi will be disabled. Reset WiFi before attempting reconnection.

Spot Cleaning

In the Standby or Pause mode, press and hold the ⏸ button to start spot cleaning. This mode is used to clean a 1.5m x 1.5m square area centered on the robot. After cleanup, the robot will return to the center of the square.

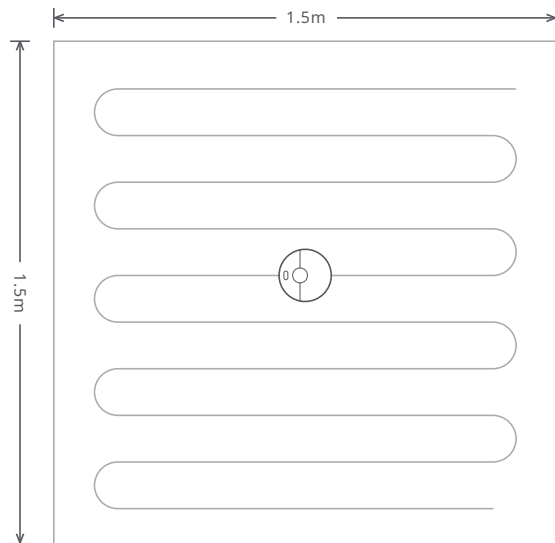

Note:

Pressing any button will cancel the current spot cleaning cycle.

Instructions for use

Selective Room Cleaning

Select specific rooms for cleaning in the app. In this mode, the robot will only clean the selected rooms.

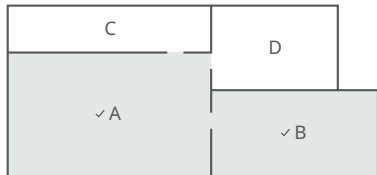

Note:

- A full map must be created and Map Saving mode switched on before this function can be used.
- After cleaning starts, the robot may move beyond the defined areas. Make sure there are no obstacles preventing the robot's access to the target rooms.

Scheduled Cleaning

Use the app to set start times and suction levels for scheduled cleanups. The robot will return to the charging dock after each cleanup.

Zone Cleaning

Use the app to draw a specific zone for the robot to clean.

Note:

While cleaning the designated zone, the robot may move outside zone borders. Make sure that there are no cables or obstacles placed close to the cleanup zone.

Pin n Go

Use the app to set a destination for the robot to go to.

Cleaning mode

Use the app to choose from Quiet, Balanced, Strong, or MAX modes. Balanced mode is the default.

Do Not Disturb (DND) mode

In DND mode, no cleanups will start, no voice alerts will play, and the power indicator will dim. DND mode set from 22:00 to 08:00 by default and can be disabled or modified in the app.

Instructions for use

No-go zones / Invisible Wall / Mopping No-Go Zone

The app can be used to draw Virtual No-Go Zones and Walls, as well as Virtual No-Mop Zones and Walls to keep the robot from entering the areas you define. Virtual No-Mop Zones and Walls are only activated when the mopping cloth bracket is installed.

Note:

- "Map Saving Mode" must be turned on in the app to use virtual no-go zones.
- Virtual no-go zones and walls should only be used to customize the cleaning area. They should not be used to isolate hazards.
- Moving the robot manually or making significant changes to the home environment may cause the loss of Virtual No-Go Zones and Walls.

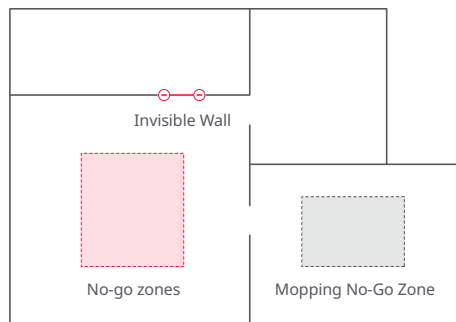

More app functions

Real-Time Map Updates	Carpet Boost	Robot Location
Change Cleaning Mode	Part Replacement Schedule	Do Not Disturb (DND) mode
View Cleaning History	Remote Control	Firmware Update
Change Robot Voice	View robot status	

Note:

Functions and details of the app may vary slightly due to continuous app development and upgrades.

Refilling the water tank or cleaning the mopping cloth midway

To refill the water tank or clean the mop cloth during a cleanup, pause cleaning by pressing any button and remove the mop module. Refill the water tank and/or clean the mop cloth as required. Reinstall the mop module and press the ⏻ button to continue cleaning.

Instructions for use

Charging dock

The charging dock should be plugged in and placed against a wall on level ground, with more than 0.5m (1.6ft) of clearance on each side, and more than 1.5m (5ft) in front. For the best experience when using the mobile app, place the charging dock in an area with strong WiFi coverage.

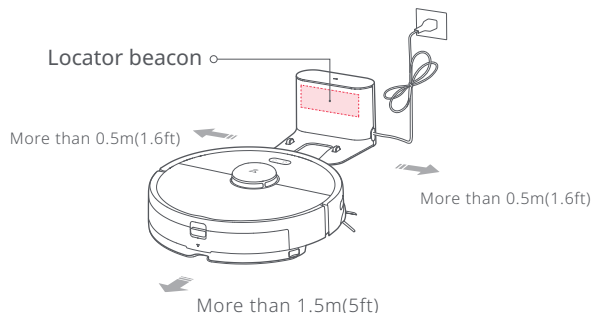

Note:

Do not place the charging dock in direct sunlight or block the locator beacon; otherwise, the robot may not be able to return to the charging dock.

Routine maintenance

Main brush

* Clean weekly

1. Turn the robot over then unlatch and remove the main brush cover.
2. Take out the main brush, remove and clean its bearings.
3. Remove the main brush cap, rotating in the unlock direction.
4. Use the supplied main brush cleaning tool to remove any entangled hair.
5. Re-install the cap and bearings following the lock direction.
6. Re-insert the main brush and replace the brush cover.

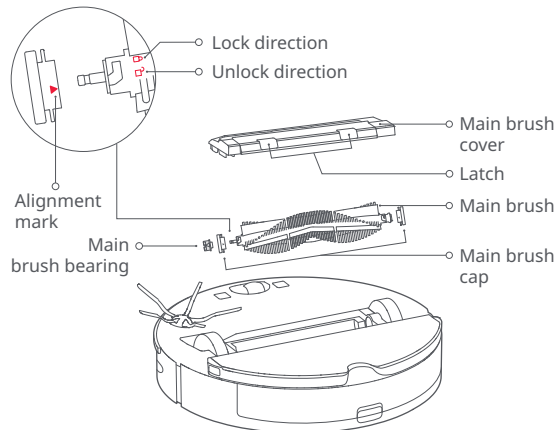

Note:

Main brush replacement every 6-12 months is recommended.

Routine maintenance

Using the main brush cleaning tool

Use the main brush cleaning tool to remove any hair entangled around the main brush.

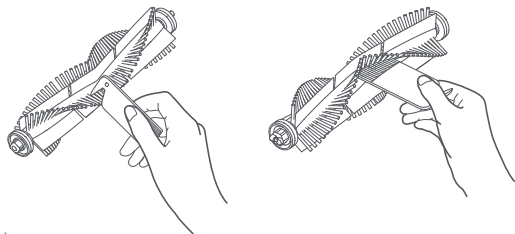

Note:

If there is a large amount of hair, or hair is tightly entangled, remove it carefully to avoid damage to the main brush.

Dustbin and filter

* Weekly cleaning is recommended

1. Open the top cover of the robot, squeeze the dustbin latch, and remove the dustbin.

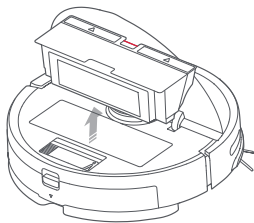

2. Open the dustbin lid as indicated by the arrow and pour out the contents.

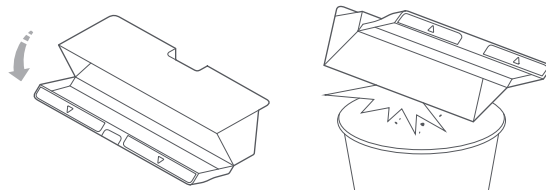

Clean the washable filter

* Clean every two weeks

1. Open the dustbin lid as indicated by the arrow and pour out the contents.

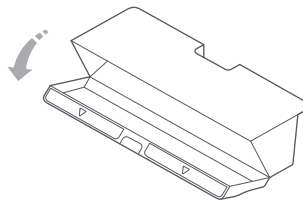

Routine maintenance

Clean the washable filter

* Clean every two weeks

2. Fill the dustbin with clean water and close the cover.
Gently shake the dustbin, then pour out the dirty water.

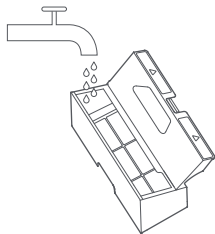

Note:
Only use fresh water without cleaning liquid.

3. Remove the filter and clean it with water.

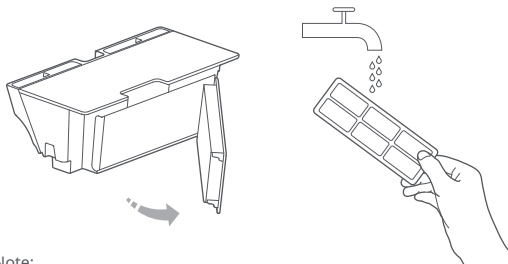

Note:
To avoid damage, do not touch the surface of the filter with hands, brushes, or sharp objects.

4. Rinse repeatedly and tap the filter frame to remove as much dirt as possible.



5. Leave the filter to dry before reinstalling it.

Note:
Allow the filter to dry thoroughly before use. 24-hours of drying is recommended.

Battery

The robot is equipped with a high-performance lithium-ion rechargeable battery pack. To maintain battery performance, keep the robot charged.

Note:
If the robot is to be left unused for an extended period, turn it off before storage and charge it at least once every three months to avoid battery damage resulting from over-discharging.

Charging dock

* Monthly cleaning recommended

Use a soft dry cloth to clean the charging contacts of the charging dock.

Routine maintenance

Side brush

* Monthly cleaning recommended

1. Turn the robot over and remove the screw holding the side brush.
2. Remove and clean the side brush.
3. Reinstall the side brush and tighten the screw.

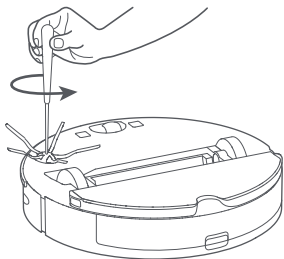

Note:

Side brush replacement every 3-6 months is recommended.

Water tank

* Frequent cleaning is recommended

1. Open the water tank.
2. Fill the filter with water
3. Shake it, and pour out the water

Mop cloth

* Clean after use

1. Remove the mop cloth from the mop cloth bracket.

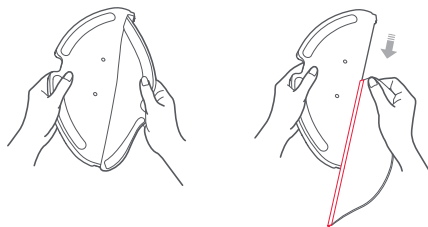

2. Clean the mop cloth and dry it.

Note:

- If the mop cloth gets excessively dirty, cleaning quality will be affected. Cleaning it before use is recommended.
- Replacing the mop cloth every 3-6 months is recommended to maintain cleaning quality.

Routine maintenance

Omnidirectional wheel

* Frequent cleaning is recommended

1. Turn the robot over.
2. Use a small screwdriver to separate the axle and the tire.
3. Rinse the axle and tire with water to remove any hair and dirt.
4. Dry and rebuild the wheel, then press it back in place.

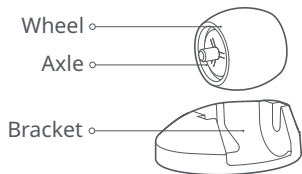

Note:

The omnidirectional wheel bracket cannot be removed.

System Reset

If the robot does not respond when you press a button or the robot cannot be shut down, press the Reset button. The robot will then restart.

Note:

After a system reset, cleaning schedules, WiFi and other settings will be restored to factory settings.

Restore factory settings

If the robot is not functioning after a system reset, turn it on, then press the Reset button. Then press and hold the  button until you hear the "Start restoring initial version" voice alert. The robot will then be restored to factory settings.

Machine sensors

* Monthly cleaning recommended

Use a soft dry cloth to wipe and clean all sensors, including:

1. Four cliff sensors at the bottom of the robot.
2. The wall sensor on the right of the robot.
3. The charging contact on the bottom of the robot.

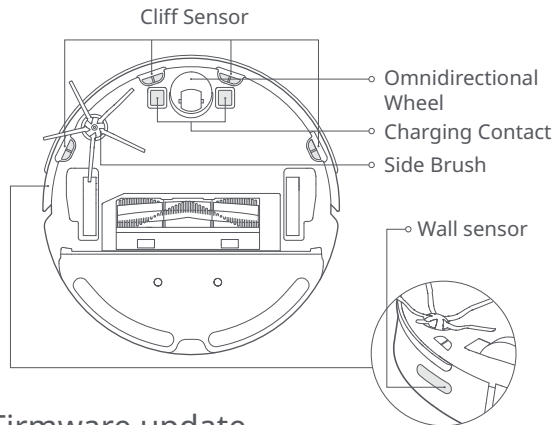

Firmware update

Update the robot using the app. Place the robot on the charging dock and ensure that the battery level is higher than 20% before updating. The power indicator will flash white quickly during a firmware update.

Environmental protection description

Removing the battery

* The following information applies only when disposing of the robot and should not be followed for day-to-day operations

The chemical substances contained in the built-in lithium-ion battery of this product can cause environmental pollution. Remove the battery before disposing of this product and hand it to a professional battery recycling facility for centralized disposal.

1. Operate the robot until it has low battery and is unable to clean, ensuring it does not connect to the charging dock.
2. Turn off the robot.
3. Unscrew the battery cover.
4. Remove the battery cover.
5. Press the clip to pull out the battery connector and remove the battery.

Note:

- Before removing the battery, make sure it is fully drained. Do not attempt to remove the battery if the robot is connected to the charging dock.
- Remove the entire battery pack. Avoid damaging the battery pack casing to avoid short-circuits or leakage of hazardous substances.
- In the event of accidental contact with battery fluid, rinse thoroughly with water and seek immediate medical care.

Basic parameters

Robot

Name	Parameters
Model	S5 Max
Dimensions	353×350×96.5mm
Battery	14.4V/5200mAh lithium battery
Weight	Approx. 3.5 kg
Wireless connection	WiFi Smart Connect
Rated voltage	14.4VDC
Rated power	58W

Note:

The serial number is on a sticker on the underside of the robot.

WiFi Specification

Service	Protocol	Frequency Range	Max. Output Power
WiFi	802.11b/g/n	2400-2483.5 MHz	≤ 20dBm

Charging dock

Name	Parameters
Model	CDZ11RR or CDZ12RR
Dimensions	151×130×98mm
Rated power	28W
Rated input	100-240VAC
Rated output	20VDC 1.2A
Rated frequency	50-60Hz

Troubleshooting

If an error occurs during cleanup, the power indicator will flash red quickly, and a voice alert will play. Refer to the table below for resolution options.

Error	Solution
Error 1: Rotate the laser head to check that it turns freely.	The LDS unit is jammed. Remove any items blocking it then move the robot to a new location and restart.
Error 2: Clean and lightly tap the bumper.	The bumper is stuck. Tap the bumper repeatedly to dislodge any jammed items. If nothing falls out, move the robot to a new location and restart.
Error 3: Move the robot to a new location and restart.	A wheel is suspended. Move the robot to a new location and restart.
Error 4: Wipe the cliff sensors, move the robot away from raised edges, and restart.	The robot is suspended. Move it to a new location and restart. If the problem persists, clean the cliff sensors. This error may also be caused by a dirty cliff sensor. Try wiping all sensors clean.
Error 5: Remove the main brush and clean the brush and bearing.	The main brush may be tangled up. Remove and clean it.
Error 6: Remove and clean the side brush.	The side brush may be tangled up. Remove and clean it.
Error 7: Look for anything stuck in the main wheels then move the robot to a new location and restart.	The main wheels may be jammed. Remove and clean them.
Error 8: Clear away any obstacles around the robot.	The robot may be stuck. Clear any obstacles around it.
Error 9: Install the dustbin and filter.	Reinstall the dustbin and filter and check that they are installed properly. If the problem persists, try replacing the filter.
Error 10: The filter is either wet or blocked.	The filter is not completely dry. Dry the filter for at least 24 hours. The filter may also require cleaning. If the problem persists, replace the filter.

Troubleshooting

If an error occurs during cleanup, the power indicator will flash red quickly, and a voice alert will play. Refer to the table below for resolution options.

Error	Solution
Error 11: High-intensity magnetic field detected. Move the robot away from the magnetic tape and restart.	The robot is too close to a magnetic tape and cannot start. Move it to a new location and restart.
Error 12: The battery is too low. Recharge before use.	Low battery. Recharge before use.
Error 13: Charging error. Clean the charging contact area.	Use a dry cloth to clean the charging contacts on the robot and on the charging dock.
Error 14: Battery error.	The battery temperature is either too high or too low. Wait until it returns to normal.
Error 16: Robot is tilted. Place it on flat ground and restart.	The robot is tilted. Move it to flat ground and restart.
Error 17: Side brush module error. Reset the system.	The side brush module is experiencing a fault. Reset the system.
Error 18: Vacuum fan error. Reset the system.	The vacuum fan is experiencing a fault. Reset the system.
Error 22: Please wipe the recharge sensor.	The recharge sensor is blocked by dust. Please wipe the dust off.
Error 23: Please clear the signal emission area of the dock charger.	The charging dock is jammed. Clear and retry.
Error 24: Virtual no-go zone or wall detected. Move the robot to a new location and restart.	Move the robot away from the virtual no-go zone or barrier and restart.
Error 26: Wipe the wall sensor.	The wall sensor is dirty. Wipe it clean.
Internal error. Reset the system.	Malfunction due to an internal error. Reset the system.

Note:

A system reset may not resolve all problems.

If the problem persists after using the recommendations in the table above, please email our after-sales service team:

US/Non-Europe Support: support@roborock.com Europe Support: support@roborock-eu.com

FAQs

Problem	Solution
Unable to power on	The battery level is low. Put the robot on the charging dock to charge it before use. The battery temperature is too low or too high. Only use the robot within the range of 0-40°C (32-104°F).
Unable to charge	If the charging dock is not receiving power, check that both ends of the power cable are properly connected. If contact is poor, clean the contact areas of the charging dock and the robot. Power is restored when the power indicator light turns on.
Slow charging	When used at high or low temperatures, the machine will automatically reduce charging speed to extend battery life. The charging contact areas may be dirty. Use a dry cloth to clean them.
Unable to recharge	There are too many obstacles near the charging dock. Move it to an open area. The robot is too far from the charging dock. Place it closer and retry.
Abnormal behavior	Restart the robot.
Noise during cleaning	The main brush, side brush, or main wheels may jammed. Turn off the robot and clean them. If the omnidirectional wheel gets jammed, use a screwdriver to remove it for cleaning.
Poor cleaning ability or dust falling out	The dustbin is full and needs emptying. The filter is blocked and needs cleaning. The main brush is jammed and needs cleaning.
Unable to connect to WiFi	WiFi is disabled. Reset the WiFi and try again. WiFi signal is poor. Make sure that the robot is in an area with good WiFi signal reception. Abnormal WiFi connection. Reset the WiFi and download the latest mobile app and retry. The current device is not supported. You can find supported models inside the app. Unable to connect to WiFi. There may be an error with your router settings. Contact Roborock customer service for help with troubleshooting.

FAQs

Problem	Solution
Scheduled cleaning is not working	The battery level is too low. Scheduled cleaning can only begin when the battery level is above 20%. Please confirm whether the timed cleaning setting is set to "effective once"?
Is power always being drawn when the robot is on the charging dock?	The robot will draw power while it is docked to maintain battery performance, but power consumption is extremely low.
Does the robot need to be charged for at least 16 hours the first three times it is used?	No. The robot can be used any time after it has been fully charged once.
No or little water during mopping	Check whether there is water in the water tank and use the APP mobile app to set water flow or see the manual for full mop setup instructions.
Cleaning does not resume after recharging	Make sure that the robot is not in DND mode. DND mode will prevent cleanup. When cleaning a space requiring a top-up charge, if the robot was placed manually on the charging dock before it recharged automatically, it will not be able to continue cleanup.
The robot cannot return to the charging dock after spot cleaning or when it has been moved manually.	After spot cleaning or a significant position change, the robot will re-generate the map. If the charging dock is too far away, it may not be able to return for recharging and must be placed on the charger manually.
The robot suddenly misses a certain spot	The wall sensor or cliff sensors may be dirty. Clean them with a soft dry cloth.
It takes a long time to fill the water tank	The filter may be blocked and need cleaning.

EU Declaration of Conformity

Hereby we:

Name of manufacturer	Beijing Roborock Technology Co.,Ltd.
Address	Floor6, Suite6016, 6017, 6018, BuildingC, Kangjian Baosheng Plaza, No.8 Heiquan Road, Haidian District, Beijing, P.R.CHINA

declare that this DoC is issued under our sole responsibility and that the products:

Product description	Robotic Vacuum Cleaner and Accessories
Type(model) designation(s)	S5 Max

are in conformity and verified through testing with the provision of the following EU directives:

RED Directive 2014/53/EU Article 3.1 a): Safety&Health 1. EN 60335-1:2012 + A11:2014 + AC:2014 + A13:2017 2. EN 60335-2-2:2010 + A11:2012 + A1:2013 3. EN 62311:2008 4. EN 62233:2008	1. Household and similar electrical appliances-Safety-Part 1: General requirements 2. Household and similar electrical appliances-Safety-Part 2-2: Particular requirements for vacuum cleaners and water suction cleaning appliance 3. Assessment of electronic and electrical equipment related to human exposure restrictions for electromagnetic fields (0 Hz - 300 GHz) 4. Measurement methods for electromagnetic fields of household appliance and similar apparatus with regard to human exposure
---	---

EU Declaration of Conformity

are in conformity and verified through testing with the provision of the following EU directives:

<p>RED Directive 2014/53/EU Article 3.1 b); EMC</p> <ol style="list-style-type: none"> 1. Draft EN 301 489-1 V2.2.0 2. Draft EN 301 489-17 V3.2.0 3. EN 55014-1:2017 4. EN 55014-2: 2015 5. EN 61000-3-2: 2014 6. EN 61000-3-3: 2013 	<ol style="list-style-type: none"> 1. Electromagnetic Compatibility (EMC) standard for radio equipment and services; Part 1: Common technical requirements; Harmonized Standard covering the essential requirements of article 3.1(b) of Directive 2014/53/EU and the essential requirements of article 6 of Directive 2014/30/EU 2. Electromagnetic Compatibility (EMC) standard for radio equipment and services; Part 17: Specific conditions for Broadband Data Transmission Systems; Harmonized Standard covering the essential requirements of article 3.1(b) of Directive 2014/53/EU 3. Electromagnetic Compatibility-Requirements for household appliances, electric tools and similar apparatus Part 1: Emission 4. Electromagnetic compatibility – Requirements for household appliances, electric tools and similar apparatus Part 2: Immunity – Product family standard 5. Electromagnetic compatibility (EMC) - Part 3-2: Limits - Limits for harmonic current emissions (equipment input current ≤ 16 A per phase). 6. Electromagnetic compatibility (EMC) - Part 3-3: Limits - Limitation of voltage changes, voltage fluctuations and flicker in public low-voltage supply systems, for equipment with rated current ≤ 16 A per phase and not subject to conditional connection.
<p>RED Directive 2014/53/EU Article 3.2: Radio Spectrum EN 300 328 V2.1.1</p>	<p>Wideband transmission systems; Data transmission equipment operating in the 2,4 GHz ISM band and using wide band modulation techniques; Harmonized Standard covering the essential requirements of article 3.2 of Directive 2014/53/EU</p>
<p>RoHS Directive 2011/65/EU EN50581:2012</p>	<p>Technical documentation for the assessment of electrical and electronic products with respect to the restriction of hazardous substances</p>
<p>Product description</p>	<p>Charging Dock and Accessories</p>
<p>Type(model) designation(s)</p>	<p>Charging Dock , model: CDZ11RR or CDZ12RR</p>

EU Declaration of Conformity

are in conformity and verified through testing with the provision of the following EU directives:

<p>Low Voltage Directive 2014/35/EU</p> <ol style="list-style-type: none">1. EN 60335-1:2012 + A11:2014+AC:2014+A13:20172. EN 60335-2-29:2004 + A2:2010+A11: 20183. EN 62233:2008	<ol style="list-style-type: none">1. Household and similar electrical appliances-Safety-Part 1: General requirements2. Household and similar electrical appliances-Safety-Part 2-29: Particular requirements for battery chargers3. Measurement methods for electromagnetic fields of household appliance and similar apparatus with regard to human exposure
<p>EMC Directive 2014/30/EU</p> <ol style="list-style-type: none">1. EN 55014-1:2006+A1+A2 EN 55014-1:20172. EN 55014-2: 20153. EN 61000-3-2: 20144. EN 61000-3-3: 2013	<ol style="list-style-type: none">1. Electromagnetic Compatibility-Requirements for household appliances, electric tools and similar apparatus Part 1: Emission2. Electromagnetic compatibility – Requirements for household appliances, electric tools and similar apparatus Part 2: Immunity – Product family standard3. Electromagnetic compatibility (EMC) - Part 3-2: Limits - Limits for harmonic current emissions (equipment input current ≤ 16 A per phase).4. Electromagnetic compatibility (EMC) - Part 3-3: Limits - Limitation of voltage changes, voltage fluctuations and flicker in public low-voltage supply systems, for equipment with rated current ≤ 16 A per phase
<p>RoHS Directive 2011/65/EU EN50581:2012</p>	<p>Technical documentation for the assessment of electrical and electronic products with respect to the restriction of hazardous substances</p>

Person responsible for making this declaration:

Printed name: Rui.Shen

Position/Title: Quality Director

Signature: *Rui Shen*

Date of issue: Dec.30.2019

Place of issue: Floor 6, Suite 6016, 6017, 6018, Building C, Kangjian Baosheng Plaza,
No. 8 Heiquan Road, Haidian District, Beijing, P.R. CHINA

WEEE Information

Correct Disposal of this product . This marking indicates that this product should not be disposed with other household wastes throughout the EU. To prevent possible harm to the environment or human health from uncontrolled waste disposal, recycle it responsibly to promote the sustainable reuse of material resources. To return your used device, please use the return and collection systems or contact the retailer where the product was purchased. They can take this product for environmental safe recycling.

Korrekte Entsorgung dieses Produkts Innerhalb der EU weist dieses Symbol darauf hin, dass dieses Produkt nicht über den Hausmüll entsorgt werden darf. Altgeräte enthalten wertvolle recyclingfähige Materialien, die einer Wiederverwertung zugeführt werden sollten und um der Umwelt bzw. der menschlichen Gesundheit nicht durch unkontrollierte Müllbeseitigung zu schaden. Bitte entsorgen Sie Altgeräte deshalb über geeignete Sammelsysteme oder senden Sie das Gerät zur Entsorgung an die Stelle, bei der Sie es gekauft haben. Diese wird dann das Gerät der stofflichen Verwertung zuführen.



Warranty Information

Warranty Information

The seller provides warranty in accordance with the legislation of the customer's own country of residence, with a minimum of 1 year, starting from the date on which the appliance is sold to the end user.

The warranty only covers defects in material or workmanship.

The repairs under warranty may only be carried out by an authorized service centre. When making a claim under the warranty, the original bill of purchase (with purchase date) must be submitted.

The warranty will not apply in cases of:

Normal wear and tear

Incorrect use, e.g. overloading of the appliance, use of non-approved accessories Use of force, damage caused by external influences Damage caused by non-observance of the user manual,

e.g. connection to an unsuitable mains supply or non-compliance with the installation instructions

Partially or completely dismantled appliances.

Laser Safety

The laser distance sensor of this product meets the standards for Class I Laser Products in IEC 60825-1:2014 and will not generate hazardous laser radiation.



Robot Vacuum Cleaner

Manufacturer: Beijing Roborock Technology Co., Ltd.

Product Model: S5 Max

Address of Manufacturer: Floor 6, Suite 6016, 6017, 6018, Building C, Kangjian Baosheng Plaza,
No.8 Heiquan Road, Haidian District, Beijing, P.R.CHINA

For more product information, visit our website: www.roborock.com

For after-sales support, email our after-sales service team:

US/Non-Europe Support: support@roborock.com

Europe Support: support@roborock-eu.com