

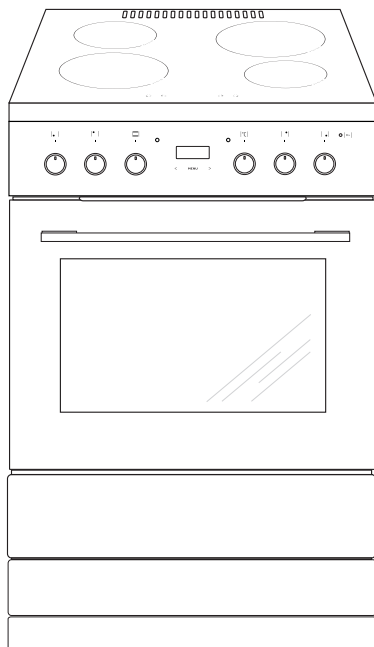

**Type**

**SIP 17626**

**SIP 17626 X**



**EN INSTRUCTION MANUAL**

## DEAR CUSTOMER,

---

*The cooker is exceptionally easy to use and extremely efficient. After reading the instruction manual, operating the cooker will be easy.*

*Before being packaged and leaving the manufacturer, the cooker was thoroughly checked with regard to safety and functionality.*

*Before using the appliance, please read the instruction manual carefully. By following these instructions carefully you will be able to avoid any problems in using the appliance.*

*It is important to keep the instruction manual and store it in a safe place so that it can be consulted at any time.*

*It is necessary to follow the instructions in the manual carefully in order to avoid possible accidents.*

### **Caution!**

*Do not use the cooker until you have read this instruction manual.*

*The cooker is intended for household use only.*

*The manufacturer reserves the right to introduce changes which do not affect the operation of the appliance.*

# TABLE OF CONTENTS

---

<b>Safety instructions</b> .....	4
<b>Description of the appliance</b> .....	9
<b>Installation</b> .....	11
<b>Operation</b> .....	13
<b>Baking in the oven – practical hints</b> .....	30
<b>Test dishes</b> .....	33
<b>Cleaning and maintenance</b> .....	35
<b>Technical data</b> .....	42

## SAFETY INSTRUCTIONS

---

**Warning:** The appliance and its accessible parts become hot during use. Care should be taken to avoid touching heating elements. Children less than 8 years of age shall be kept away unless continuously supervised.

This appliance can be used by children aged from 8 years and above and persons with reduced physical, sensory or mental capabilities or lack of experience and knowledge if they have been given supervision or instruction concerning use of the appliance in a safe way and understand the hazards involved. Children shall not play with the appliance. Cleaning and user maintenance shall not be made by children without supervision.

**Warning:** Unattended cooking on a hob with fat or oil can be dangerous and may result in fire.

NEVER try to extinguish a fire with water, but switch off the appliance and then cover flame e.g. with a lid or a fire blanket.

**Warning:** Danger of fire: do not store items on the cooking surfaces.

**Warning:** If the surface is cracked, switch off the appliance to avoid the possibility of electric shock.

Metallic objects, such as knives, forks, spoons and lids should not be placed on the hob surface since they can get hot.

After use, switch off the hob element by its control and do not rely on the pan detector.

During use the appliance becomes hot. Care should be taken

## SAFETY INSTRUCTIONS

---

to avoid touching heating elements inside the oven.

**Warning:** Accessible parts may become hot during use. Young children should be kept away.

Do not use harsh abrasive cleaners or sharp metal scrapers to clean the oven door glass since they can scratch the surface, which may result in shattering of the glass.

**Warning:** Ensure that the appliance is switched off before replacing the lamp to avoid the possibility of electric shock.

You should not use steam cleaning devices to clean the appliance.

During the pyrolytic oven cleaning process the oven chamber can reach a very high temperature. Consequently, the appliance outer surfaces can heat up more than usual, so keep children away at all times.

Danger of burns! Hot steam may escape when you open the oven door. Be careful when you open the oven door during or after cooking. Do NOT lean over the door when you open it. Please note that depending on the temperature the steam can be invisible.

**Caution:** The cooking process has to be supervised. A short term cooking process has to be supervised continuously.

**Warning:** Use only hob guards designed by manufacturer of the cooking appliance or indicated by the manufacturer of the appliance in the instructions for use as suitable or hob guards incorporated in the appliance. The use of inappropriate guards can cause accidents.

---

## SAFETY INSTRUCTIONS

---

- Always keep children away from the cooker.  
While in operation direct contact with the cooker may cause burns!
- Ensure that small items of household equipment, including connection leads, do not touch the hot oven or the hob as the insulation material of this equipment is usually not resistant to high temperatures.
- Do not leave the cooker unattended when frying. Oils and fats may catch fire due to overheating or boiling over.
- Do not allow the hob to get soiled and prevent liquids from boiling over onto the surface of the hob. This refers in particular to sugar which can react with the ceramic hob and cause irreversible damage. Any spillages should be cleaned up as they happen.
- Do not place pans with a wet bottom on the warmed up heating zones as this can cause irreversible changes to the hob (irremovable stains).
- Use pans that are specified by the manufacturer as designed for use with a ceramic hob.
- If any defects, deep scratches, cracks or chips appear on the ceramic hob, stop using the cooker immediately and contact the service centre.
- Do not switch on the hob until a pan has been placed on it.
- Do not use pans with sharp edges that may cause damage to the ceramic hob.
- Do not look directly at the halogen heating zones (not covered by a pan) when they are warming up.
- Do not put pans weighing over 15 kg on the opened door of the oven and pans over 25 kg on the hob.
- Do not use harsh cleaning agents or sharp metal objects to clean the door as they can scratch the surface, which could then result in the glass cracking.
- Do not use the cooker in the event of a technical fault. Any faults must be fixed by an appropriately qualified and authorised person.
- In the event of any incident caused by a technical fault, disconnect the power and report the fault to the service centre to be repaired.
- Never allow children to remain unattended near the cooktop nor to play with the control panel.
- **People with life function support implants (such as a heart pacemaker, an insulin pump, or a hearing aid) must make sure that the operation of these devices is not disturbed by the induction plate (induction plate frequency range is 20 to 50 kHz).**
- The appliance has been designed only for cooking. Any other use (for example for heating) does not comply with its operating profile and may cause danger.

## HOW TO SAVE ENERGY

---



Using energy in a responsible way not only saves money but also helps the environment. So let's save energy! And this is how you can do it:

- **Use proper pans for cooking.**

Pans with thick, flat bases can save up to 1/3 on electric energy. Remember to cover pans if possible otherwise you will use four times as much energy!

- **Match the size of the saucepan to the surface of the heating zone.**

A saucepan should never be smaller than a heating zone.

- **Ensure heating zones and pan bases are clean.**

Soils can prevent heat transfer – and repeatedly burnt-on spillages can often only be removed by products which cause damage to the environment.

- **Do not uncover the pan too often (a watched pot never boils!).**

Do not open the oven door unnecessarily often.

- **Switch off the oven in good time and make use of residual heat.**

For long cooking times, switch off heating zones 5 to 10 minutes before finishing cooking. This saves up to 20% on energy.

- **Only use the oven when cooking larger dishes.**

Meat of up to 1 kg can be prepared more economically in a pan on the cooker hob.

- **Make use of residual heat from the oven.**

If the cooking time is greater than 40 minutes switch off the oven 10 minutes before the end time.

**Important!** When using the timer, set appropriately shorter cooking times according to the dish being prepared.

- **Only grill with the ultrafan after closing the oven door.**

- **Make sure the oven door is properly closed.**

Heat can leak through spillages on the door seals. Clean up any spillages immediately.

- **Do not install the cooker in the direct vicinity of refrigerators/freezers.**

Otherwise energy consumption increases unnecessarily.

## UNPACKING

---



During transportation, protective packaging was used to protect the appliance against any damage. After unpacking, please dispose of all elements of packaging in a way that will not cause damage to the environment.

All materials used for packaging the appliance are environmentally friendly; they are 100% recyclable and are marked with the appropriate symbol.

Caution! During unpacking, the packaging materials (polythene bags, polystyrene pieces, etc.) should be kept out of reach of children.

## DISPOSAL OF THE APPLIANCE

---



Old appliances should not simply be disposed of with normal household waste, but should be delivered to a collection and recycling centre for electric and electronic equipment. A symbol shown on the product, the instruction manual or the packaging shows that it is suitable for recycling.

Materials used inside the appliance are recyclable and are labelled with information concerning this. By recycling materials or other parts from used devices you are making a significant contribution to the protection of our environment.

Information on appropriate disposal centres for used devices can be provided by your local authority.



## DESCRIPTION OF THE APPLIANCE

---

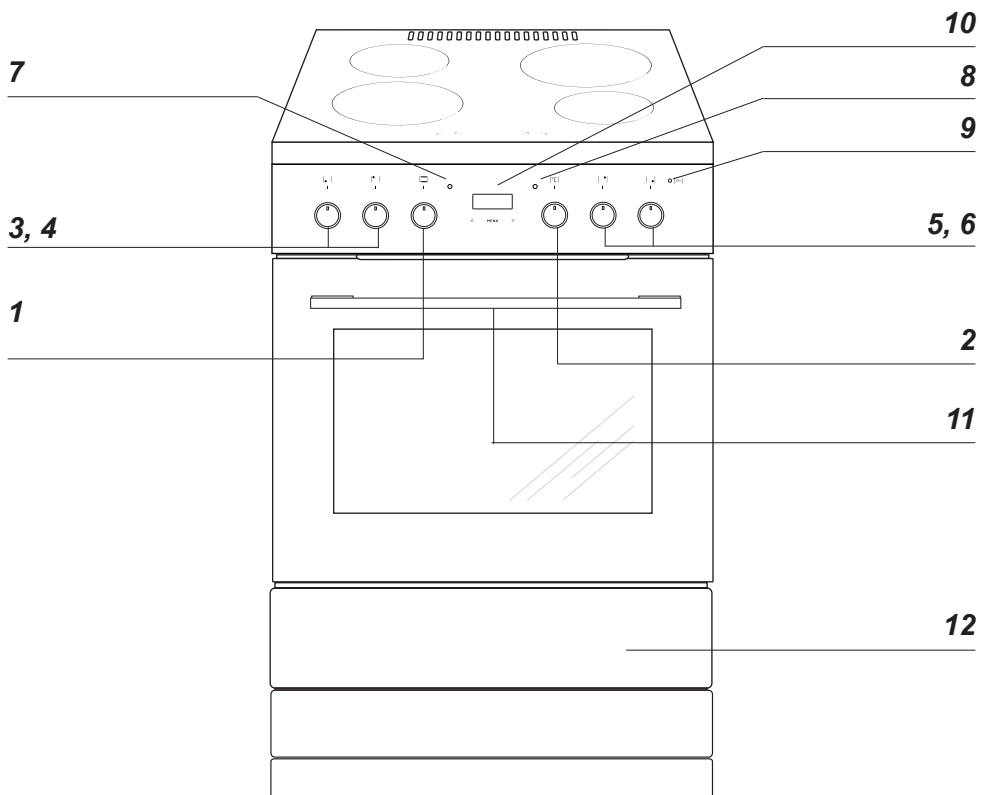

- 1** Oven function selection knob
- 2** Temperature control knob
- 3, 4, 5, 6** Heating zone control knobs
- 7** Temperature regulator signal light
- 8** Oven operation signal light
- 9** Door lock indicator light
- 10** Electronic programmer
- 11** Oven door handle
- 12** Drawer

## SPECIFICATIONS OF THE APPLIANCE

---

Cooker fittings:

*Grill grate  
(drying rack)*

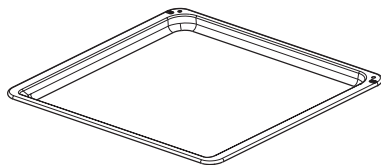
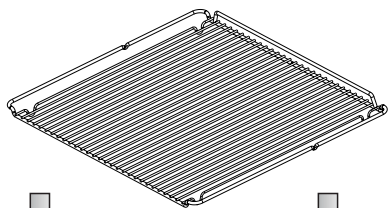

*Baking tray*

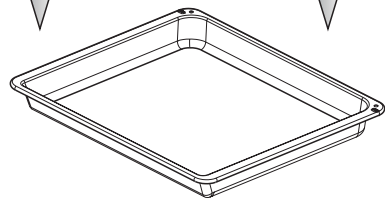

*Roasting tray*



*Meat probe*

*Sideracks*

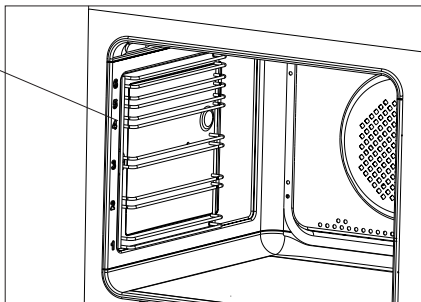

# INSTALLATION

## Installing the cooker

- The kitchen should be dry and airy and have effective ventilation according to the existing technical provisions.
- The room should be equipped with a ventilation system that pipes away exhaust fumes created during combustion. This system should consist of a ventilation grid or hood. Hoods should be installed according to the manufacturer's instructions. The cooker should be placed so as to ensure free access to all control elements.
- Coating or veneer used on fitted furniture must be applied with a heat resistant adhesive (100°C). This prevents surface deformation or detachment of the coating. If you are unsure of your furniture's heat resistance, you should leave approximately 2 cm of free space around the cooker. The wall behind the cooker should be resistant to high temperatures. During operation, its back side can warm up to around 50°C above the ambient temperature.
- The cooker should stand on a hard, even floor (do not put it on a base).
- Before you start using the cooker it should be leveled, which is particularly important for fat distribution in a frying pan. To this purpose, adjustable feet are accessible after removal of the drawer. The adjustment range is +/- 5 mm.

## Mounting the overturning prevention bracket.

The bracket is mounted to prevent overturning of the cooker. When the overturning prevention bracket is installed, a child who climbs on the oven door will not overturn the appliance.

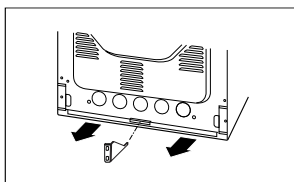
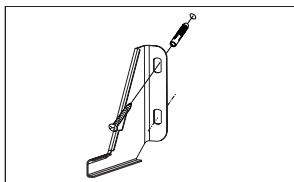
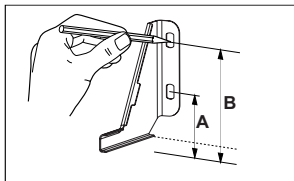

Cooker, height 900 mm  
A=104 mm  
B=147 mm

# INSTALLATION

## Installation information

The cooker is designed to be connected to one-phase 230V 1N~ mains power supply. Before connecting the appliance to the mains power supply, the user must ensure that the mains data corresponds to the information given on the manufacturer's data plate, which can be found on either the back or the right-hand side of the cooker or the copy of this plate which is enclosed with this guidance.

The cooker is equipped with a power supply cable. Before connecting the cooker to the power supply, it is important that you read the information given below.

### Connecting the cooker to the mains

- Installation must only be carried out by an authorised electrician. This will ensure that the applicable regulations in the "Heavy Current Regulation" are complied with.
- The installation must comply with any special requirements issued by the local electricity supply company.
- The cooker must be connected to a separate power supply circuit.
- Adapting the cooker to operate with three-phase 400V 3N~ mains power supply is possible by appropriate bridging in the connection box.
- The connection must only be established according to the connection diagrams below.
- When connecting or replacing the power cable, at least one H05VV-F3G4 / H05VV-F5G2.5 conduit or equivalent must be used.
- **Important:** To ensure compliance with the applicable safety requirements, a switch must be fitted which isolates all terminals and has a contact distance of at least 3 mm. (Can be a master switch).

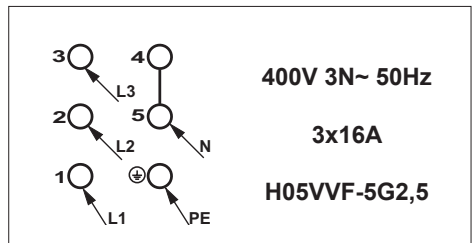
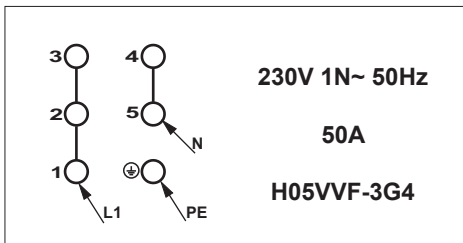
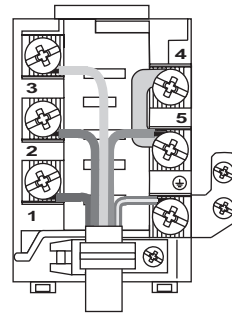
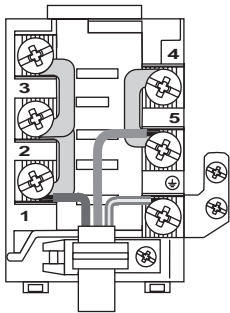

# OPERATION

## Before first use

- Remove packaging, empty the drawer, clean the interior of the oven and the hob.
- Take out and wash the oven fittings with warm water and a little washing-up liquid.
- Switch on the ventilation in the room or open a window.
- Heat the oven (to a temperature of 250°C, for approx. 30 min.), remove any stains and wash carefully; the heating zones of the hob should be heated for around 4 min. without a pan.

The oven is equipped with a retractable knobs. In order to select a function do the following:

1. Gently press and release a knob which will pop out,
2. Turn the oven functions selection knob to the desired function.

Symbols printed around the knob indicate available oven functions.

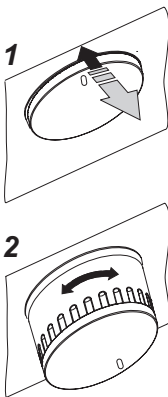

## Important!

In ovens equipped with the electronic programmer Tts, the time "0.00" will start flashing in the display field upon connection to the power supply.

**The programmer should be set with the current time. (See *Electronic programmer* ). If the current time is not set operation of the oven is impossible.**

The electronic programmer Tts is equipped with electronic sensors which are switched on by touching or pressing the sensor surface for at least one second.

Each sensor reaction is confirmed by the beep. Keep the sensor surface clean at all times.

## Important!

The inside of the oven should only be washed with warm water and a small amount of washing-up liquid.

# OPERATION

## Child safety lock

Oven door features a child safety lock device that prevents children from opening of the door. The appliance is supplied by the manufacturer with the door safety lock device engaged.

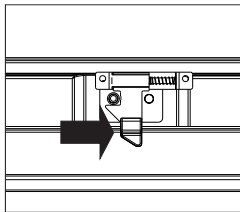
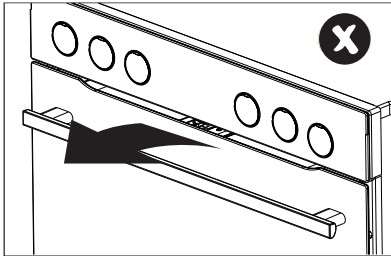

*Release the  
child safety lock.*

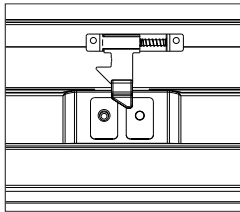

*The lock is  
released and  
you can open  
the door.*

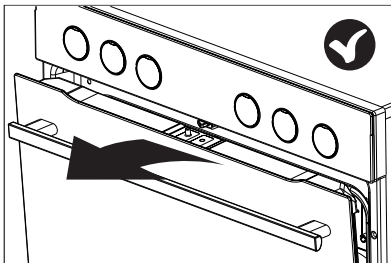

The child safety lock is re-engaged once you close the door.

# OPERATION

## Electronic programmer

 functions

Touch sensors

- 1 – function selection button
- 2 – “-” sensor
- 3 – “+” sensor

The electronic programmer is equipped with electronic sensors which are switched on by touching or pressing the sensor surface for at least 2 seconds.

Each sensor reaction is confirmed by the beep. Keep the sensor surface clean at all times.

### Setting the time

After connection to the mains or reconnection after a power cut the display shows flash 



● Press sensor 1, then the display will show ,

● set the time using sensors 3 and 2.

7 seconds after the time has been set the new data will be saved.

### Caution!

If the correct time is not set then proper operation of the oven is not possible.

## Timer

The timer can be activated at any time, regardless of the status of other functions. The timer can be set for from 1 minute to up to 23 hours and 59 minutes.

To set the timer you should:

● Press sensor 1, then the display will show flashing ,



● set the timer using sensors 3 and 2.

The time set is shown on the display and the signal function  is on.

● Press sensor 1, 2 or 3 in order to switch off the signal, the signal function will go out and the display will show the current time.

### Caution!

If the alarm signal is not turned off manually, it will be turned off automatically after approx. 7 minutes.

# OPERATION

## Semi-automatic operation

If the oven is to be switched off at a given time, then you should:

- Set the oven function knob and the temperature regulator knob to the setting at which you want the oven to operate.
- Press sensor 1 until the display will show:

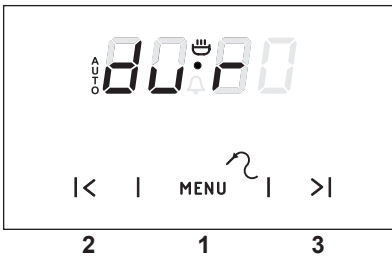

- Set the required time using sensors 3 and 2, within a range from 1 minute to 10 hours.

The set time will be introduced to the memory after approx. 7 seconds and the display will show AUTO function.

When the set time has passed the oven is switched off automatically, the alarm signal is activated and the signal function AUTO flashing again;

- Set the oven function knob and the temperature regulator knob to the switched-off position.
- Press sensor 1, 2 or 3 in order to switch off the signal; the signal function will go out and the display will show the current time.

### Caution!

In ovens equipped with one control knob, the oven function knob is integrated with the temperature regulator knob.

## Automatic operation

If the oven is to be switched on for a specified period of time and switched off at a fixed hour then you should set the operation time and the operation end time:

- Press sensor1 until the display will show:

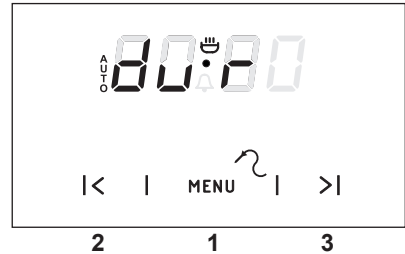

- Set the required time using the sensors 3 and 2 within a range from 1 minute to 10 hours.

- Press sensor 1 until the display will show:

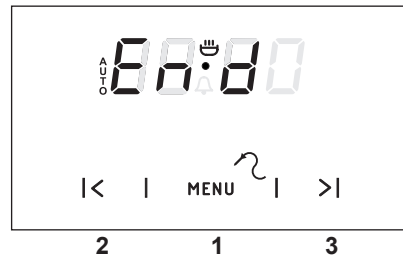

- Set the switch-off time (operation end time) using sensors 3 and 2, which is limited to a period of 23 hours and 59 minutes from the current time.

- Set the oven function knob and the temperature regulator knob to the setting at which you want the oven to operate.



## OPERATION

The function AUTO is now on; the oven will start operating from the point when the difference between the set operation end time and the operation duration time occurs (e.g. the operation time is set to 1 hour, the operation end time is set to 14.00, so the oven will start working automatically at 13.00).

When the oven reaches the operation end time it will switch off automatically, the alarm will be activated and the function AUTO will start flashing again.

- Set the oven function knob and the temperature regulator knob to the switched-off position.

- Press sensor **1**, **2** or **3** in order to switch off the alarm; the function AUTO will go out and the display will show the current time.



### Cancel settings

Timer and automatic function settings may be cancelled at any time.

Cancel automatic function settings:

- press sensors **2** and **3** simultaneously,

Cancel timer settings:

- press sensor **1** to select timer settings,
- press sensors **2** and **3** again,

### Change the timer beeps

The tone of the timer beeps may be changed as follows:

- press sensors **2** and **3** simultaneously,
- select "tone" function with the **1** sensor, the display panel will start to blink:



- with the **2** sensor press the appropriate sensors from **1** to **3** to select the option you wish.

# OPERATION

## Meat Probe

Adjustment and display range: 30°C till 99°C, Resolution: 1 Grad, Default set value: 80°C.

Meat probe is recognized automatically when temperature at meat probe is above 0°C.

If meat probe is plugged in, the two digits on the left side show the actual temperature at the meat probe and the two digits at the right side show the set point value.



If the probe temperature is lower than the minimum setting temperature of 30 °C, the display reads "30". If the probe temperature is higher than the maximum setting temperature of 99°C, the display reads the maximum setting temperature.

With plugging in the connector of the meat probe, the program is started and the nominal temperature is set to 80 °C. The value of the set temperature can be changed as long as the temperatures are displayed, but not when timer is still in start up mode.

The meat probe alarm can be reset by pressing any key.

An active meat probe program or a pending alarm can be reset by disconnecting the meat probe.

The use of temperature probe is recommended when cooking large portions of meat (at least 1 kg).

The use of temperature probe is not recommended when cooking poultry and meat with bones.

When not in use, disconnect the temperature probe from its socket and remove from oven chamber.

### Important!

Use only original temperature probe supplied with the appliance.

### Recommended probe temperature settings

Type of meat	Temperature [°C]
Pork	85 - 90
Beef	80 - 85
Veal	75 - 80
Lamb	80 - 85
Venison	80 - 85

### Pyrolytic cleaning

Pyrolytic cleaning duration can be set from 2 to 3 hours.

- set the oven function selector knob in position **P**,
- using the < and > MENU sensors, set pyrolytic cleaning duration.



**Important!** Before starting the pyrolytic cleaning, please see "Cleaning and Maintenance."

## OPERATION

---

### ▶ Before using the appliance for the first time

- thoroughly clean your induction hob first. The induction hob should be treated with the same care as a glass surface.
- switch on the ventilation in the room or open a window, as the appliance could emit an unpleasant smell during first use.
- operate the appliance while observing all safety guidelines.

### ▶ Induction cooking zone operation principle

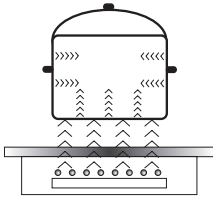

Electric oscillator powers a coil placed inside the appliance. This coil produces a magnetic field, which induces eddy currents in the cookware. These eddy currents induced by the magnetic field cause the cookware to heat up.

This requires the use of pots and pans whose base is ferromagnetic, in other words susceptible to magnetic fields.

Overall, induction technology is characterized by two advantages:

- the heat is only emitted by the cookware and its use is maximised,
- there is no thermal inertia, since the cooking starts immediately when the pot is placed on the hob and ends once it is removed.

Certain sounds can be heard during normal use of the induction hob, which do not affect its correct operation.

- Low-frequency humming. This noise arises when the cookware is empty and stops when water is poured or food is placed in the cookware.
- High-frequency whizz. This noise arises in cookware made of multiple layers of different materials at maximum heat setting. The noise intensifies when using two or more cooking zones at maximum heat setting. The noise will stop or reduce when heat setting is reduced.
- Creaking noise. This noise arises in cookware made of multiple layers of different materials. The noise intensity depends on how the food is cooked.
- Buzzing. Buzzing can be heard when electronics cooling fan operates.

The noises that can be heard during the normal appliance operation are the result of the cooling fan operation, cooking method, cookware dimensions, cookware material and the heat setting. These noises are normal and do not indicate a fault.

## OPERATION

---

### The protective device:

If the hob has been installed correctly and is used properly, any protective devices are rarely required.

**Fan:** protects and cools controls and power components. It can operate at two different speeds and is activated automatically. Fan runs until the electronic system has sufficiently cooled down regardless of the appliance or the cooking zones being turned on or off.

**Temperature sensor:** Temperature of electronic circuits is continuously monitored by a temperature sensor. If temperature is raised beyond a safe level, this protection system will reduce cooking zone heat setting or shut down the cooking zones adjacent to the overheated electronic circuits.

**Pan detection:** allows the hob to detect pans placed on a cooking zone. Small objects placed on the cooking zone (eg, spoon, knife, ring ...) will not be recognised as pans and the hob will not operate.

### Pan detector

Pan detector is installed in induction hobs. Pan detector starts heating automatically when a pan is detected on a cooking zone and stops heating when it is removed. This helps save electricity.

- When a suitable pan is placed on a cooking zone, the display shows the heat setting.
- Induction requires the use of suitable cookware with ferromagnetic base (see Table).

If a pan is not placed on a cooking zone or the pan is unsuitable, the  symbol is displayed. The cooking zone will not operate. If a pan is not detected within 1 minute, the cooking zone will be switched off.

Switch off the cooking zone using the touch control sensor field rather than by removing the pan.

### Pan detector does not operate as the on/off sensor.

The induction hob is equipped with electronic touch control sensor fields, which are operated by touching the marked area with a finger.

Each time a sensor field is touched, an acoustic signal can be heard.

When switching the appliance on or off or changing the heat setting, attention should be paid that only one sensor field at a time is touched. When two or more sensor fields are touched at the same time (except timer and child lock), the appliance ignores the control signals and may trigger a fault indication if sensor fields are touched for a long time. When you finish cooking switch off the cooking zone using touch control sensor fields and do not rely solely on the pan detector.

## OPERATION

The high-quality cookware is an essential condition for efficient induction cooking.

### Select cookware for induction cooking

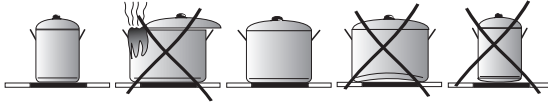

#### Cookware characteristics.

- Always use high quality cookware, with perfectly flat base. This prevents the formation of local hot spots, where food might stick. Pots and pans with thick steel walls provide superior heat distribution.
- Make sure that cookware base is dry: when filling a pot or when using a pot taken out of the refrigerator make sure its base is completely dry before placing it on the cooking zone. This is to avoid soiling the surface of the hob.
- Lid prevents heat from escaping and thus reduces heating time and lowers energy consumption.
- To determine if cookware is suitable, make sure that its base attracts a magnet.
- **Cookware base has to be flat for optimal temperature control by the induction module.**
- **The concave base or deep embossed logo of the manufacturer interfere with the temperature induction control module and can cause overheating of the pot or pan.**
- **Do not use damaged cookware such as cookware with deformed base due to excessive heat.**
- When you use large ferromagnetic base cookware, whose diameter is less than the total diameter of the cookware, only the ferromagnetic base heats up. This results in a situation where it is not possible to uniformly distribute the heat in the cookware. If the ferromagnetic area is reduced due to inclusion of aluminium parts then the effective heated area can be reduced. Problems with the detection of the cookware could arise or cookware may not be detected at all. To achieve optimum cooking results, the diameter of the ferromagnetic base should match that of the cooking zone. If cookware is not detected in a given cooking zone, it is advisable to try it in a smaller cooking zone.

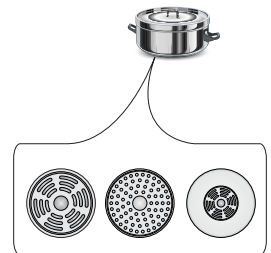

## OPERATION

For induction cooking us only ferromagnetic base materials such as:

- enamelled steel
- cast iron
- special stainless steel cookware designed for induction cooking.

<b>Marking of kitchen cookware</b>		<b>Check for marking indicating that the cookware is suitable for induction cooking.</b>
	Use magnetic cookware (enamelled steel, ferrite stainless steel, cast iron). The easiest way to determine if your cookware is suitable is to perform the „magnet test“. Find a generic magnet and check if it sticks to the base of the cookware.	
<b>Stainless Steel</b>	Cookware is not detected	
	With the exception of the ferromagnetic steel cookware	
<b>Aluminium</b>	Cookware is not detected	
<b>Cast iron</b>	High efficiency	
	Caution: cookware can scratch the hob surface	
<b>Enamelled steel</b>	High efficiency	
	Cookware with a flat, thick and smooth base is recommended	
<b>Glass</b>	Cookware is not detected	
<b>Porcelain</b>	Cookware is not detected	
<b>Cookware with copper base</b>	Cookware is not detected	

### Cookware size.

- In order to achieve best cooking results, use cookware with bottoms (ferromagnetic part) of the size corresponding to the size of the cooking zone.
- Using cookware with the bottom diameter smaller than the cooking zone size will reduce the effectiveness of the cooking zone and increase cooking time.
- Cooking zones have a lower pot detection limit that depends on the diameter of ferromagnetic part of the pot bottom and the pot material. The use of an unsuitable pot might lead to pot being undetected by a cooking zone.

Induction cooktop	Diameter of the bottom of a pot for induction cooking	
	Diameter (mm)	Minimum (mm)
210	120	210
160	110	160

## OPERATION

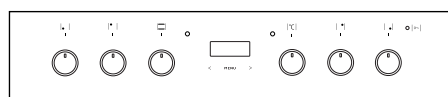
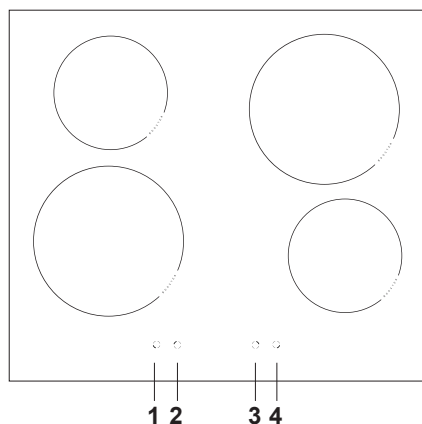

1 2 3 4

- [1] Front left cooking zone Ø 210 mm  
2000 W / 300W
- [2] Back left cooking zone Ø 160 mm  
1200 W / 1400W
- [3] Back right cooking zone Ø 210 mm  
2000 W / 300W
- [4] Front right cooking zone Ø 160 mm  
1200 W / 1400W

When the induction hob is switched off then all the cooking zones are disconnected and the indicators are off.



The cooking zones have variable heating power. The heating power can be adjusted by turning the dial left or right.

Heating power	Use
0	Switched off Use of residual heat.
1-2	Heating up hot meals. Slow cooking of smaller portions
3	Slow cooking on low power
4-5	Long preparation of larger portions and frying larger portions
6	Frying, roasting
7-8	Frying
9	Starting to prepare dishes, frying
A	Automatic parboiling function
P	Booster function (extra boost energy for quicker cooking).

### Switching on the induction hob

- Switch on the cooking zone using the dial on the control panel.
- The symbols by the knobs indicate which dial operates each cooking zone.
- The desired heating power can be set immediately (1-9).
- The set heating power is also shown on the hob's display.

## OPERATION

### The child lock function

You can disable any of the cooking zones by activating the child lock function. This protects your children.

Activating the child lock function.

- The child lock function can be activated when all knobs are set to "0" position.
- Simultaneously turn both knobs [1] and [4] to the left and hold for 3 seconds. All the indicators show the "L" symbol. The child lock function has been activated.

Turning any of the hob's knob causes all the indicators to show the "L".



Deactivate child lock.

- Simultaneously turn both control knobs [1] and [4] to the right to position "P" and hold both knobs at this position for 1 second and then turn both knobs back to "0". The child lock "L" symbol will disappear from displays and child lock will deactivate.

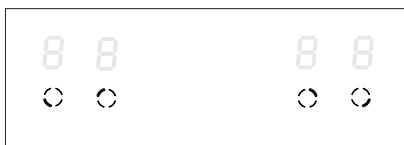

#### **Important!**

After disconnecting from the mains, the child lock function is activated.

### The residual heat indicator **H**

The hob is also equipped with a residual heat indicator "H". Even if a cooking zone is not directly heated, it takes in heat from the base of a pot or pan. As long as the "H" symbol is lit, any residual heat can be used for heating a pot or pan or melting fat. When the indication goes out, you can touch the cooking zone, bearing in mind that it still does not have the ambient temperature.

#### **Important!**

When there is no power, the residual heat indicator does not light up.

### Automatic parboiling function

All four cooking zones are fitted with a special function which allows each of them to start on full heating power regardless of the power currently set. After a certain time the heating power returns to that which is set (from 1 to 8). To use this function, choose the level which is to be used to heat the dish, or to which the power is to return.

The auto parboiling function is useful when:

- dishes are cold at the start of cooking and need intensive heating, so that they can then be cooked on low power so that they do not need to be constantly watched (e.g. beef ragout).

The auto parboiling function is not useful when:

- baking or steaming a dish which needs to be stirred, mixed or have water added;
- you are boiling pasta or dumplings in a large amount of water;
- you are preparing dishes which require long cooking in a pressure cooker.



# OPERATION

Activating the auto parboiling function:

- Set the dial to „A”, then turn it back to the required power. The indicator will alternate between showing the „A” symbol and the chosen power level. After the increased power cooking (e.g. 5) is finished, the cooking zone returns to the power level shown on the display

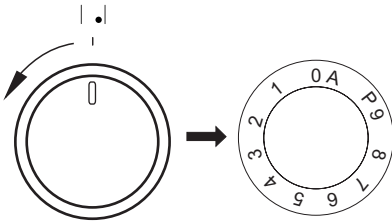

**A.** shown on the display

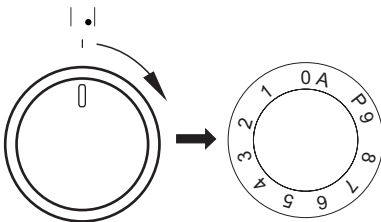

On indicator **5**

Instructions:

- If the knob is in the “0” position immediately after selecting the auto parboiling function (i.e. no cooking power level has been set), the auto parboiling function switches off after three seconds.
- Removing a pan from a cooking zone and replacing it on the same cooking zone within ten minutes does not cancel the set auto parboiling function.

The cooking zone is switched on at full power for a time depending on the heat setting selected, and is then switched back to the heat setting set.

Cooking heat level	Time automatic paraboiling function is active (seconds)
1	48
2	72
3	136
4	208
5	264
6	432
7	120
8	192
9	-

# OPERATION

---

## Limiting the operating time

---

In order to increase efficiency, the induction hob is fitted with a operating time limiter for each of the cooking zones. The maximum operating time is set according to the last heating power level selected. If you do not change the heating power level for a long time (see table) then the associated cooking zone is automatically switched off and the residual heat indicator is activated. However, we you switch on and operate individual cooking zones at any time in accordance with the operating instructions.

Cooking heat level	Maximum operating time (min)
1	480
2	480
3	300
4	300
5	300
6	90
7	90
8	90
9	90
P	10

**In order to conserve electricity, after 30 minutes heating setting "9" will be automatically reduced to the heat setting "8", but cook time will not change.**

# OPERATION

## Oven functions and operation

### Oven with automatic air circulation (including a fan and an ultra-fan heater)

The oven can be heated up using the bottom and top heaters, the grill or the ultra-fan heater. Operation of the oven is controlled by the oven function knob – to set a required function you should turn the knob to the selected position, and the temperature regulator knob – to set a required function you should turn the knob to the selected position.

The oven is equipped with a retractable knobs. In order to select a function do the following:

- Gently press and release a knob which will pop out,
- Turn the oven functions selection knob to the desired function.

Symbols printed around the knob indicate available oven functions.

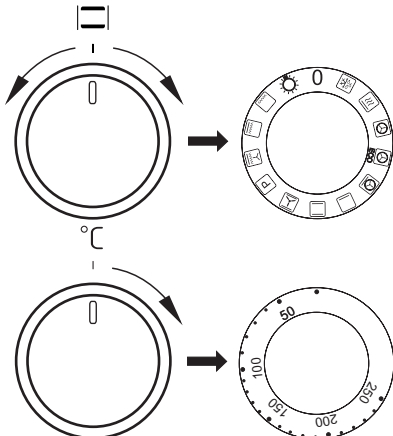

The oven can be switched off by setting both of these knobs to the position “●”/“0”.

#### Caution!

When selecting any heating function (switching a heater on etc.) the oven will only be switched on after the temperature has been set by the temperature regulator knob.

**0** Oven is off



#### Defrosting

Only fan is on and all heaters are off.



#### Rapid Preheating

Ring heater and roaster on. Use to preheat the oven.



#### Convection with ring heating element

Setting the knob in this position allows the oven to be heated up by a heating element with air circulation forced by a rotating fan fitted in the central part of the back wall of the oven chamber. Lower baking temperatures than in the conventional oven can be used. Heating the oven up in this manner ensures uniform heat circulation around the dish being cooked in the oven.



#### Eco fan assisted heating

This is an optimised heating function designed to save energy when preparing food. At this knob position, the oven lighting is off.



#### Convection with ring heating element and bottom heater on

With this setting the convection fan and bottom heater are on, which increases the temperature at the bottom of the cooked dish. Intense heat from the bottom, moist cakes, pizza.



#### Bottom heater on

When the knob is set to this position the oven is heated using only the bottom heater. Baking of cakes from the bottom until done (moist cakes with fruit stuffing).



#### Top and bottom heaters on

Set the knob in this position for conventional baking. This setting is ideal for baking cakes, meat, fish, bread and pizza (it is necessary to preheat the oven and use a baking tray) on one oven level.

## OPERATION



### Top heater, bottom heater and fan are on

This knob setting is most suitable for baking cakes. Convection baking (recommended for baking).

When the  functions have been selected but the temperature knob is set to zero only the fan will be on. With this function you can cool the dish or the oven chamber.



### Pyrolytic cleaning

Oven pyrolytic self-cleaning. The oven heats up to a temperature of about 480°C. Grilling or baking residue is burnt into an easy to remove ash that can be wiped off with a damp cloth.

### Important!

Before starting the pyrolytic cleaning, please see "Cleaning and Maintenance."



### Fan and combined grill on

When the knob is turned to this position, the oven activates the combined grill and fan function. In practice, this function allows the grilling process to be speeded up and an improvement in the taste of the dish. You should only use the grill with the oven door shut.



### Enhanced roaster (super roaster)

In this setting both roaster and top heater are on. This increases temperature in the top part of the oven's interior, which makes it suitable for browning and roasting of larger portions of food.



### Roaster on

Roasting is used for cooking of small portions of meat: steaks, schnitzel, fish, toasts, Frankfurter sausages, (thickness of roasted dish should not exceed 2-3 cm and should be turned over during roasting).



### Independent oven lighting

Set the knob in this position to light up the oven interior.

Switching on the oven is indicated by two signal lights, **7**, **8**, turning on. The **8** light turned on means the oven is working. If the **7** light goes out, it means the oven has reached the set temperature. If a recipe recommends placing dishes in a warmed-up oven, this should be not done before the **7** light goes out for the first time. When baking, the **7** light will temporarily come on and go out (to maintain the temperature inside the oven). The **8** signal light may also turn on at the knob position of "oven chamber lighting".

# OPERATION

---

## Use of the grill

---

The grilling process operates through infrared rays emitted onto the dish by the incandescent grill heater.

In order to switch on the grill you need to:

- Set the oven knob to the position marked grill ,
- Heat the oven for approx. 5 minutes (with the oven door shut).
- Insert a tray with a dish onto the appropriate cooking level; and if you are grilling on the grate insert a tray for dripping on the level immediately below (under the grate).
- Close the oven door.

**For grilling with the function grill and combined grill the temperature must be set to 220°C, but for the function fan and grill it must be set to a maximum of 190°C.**

### **Warning!**

When using function grill it is recommended that the oven door is closed.

When the grill is in use accessible parts can become hot.

It is best to keep children away from the oven.

## BAKING IN THE OVEN – PRACTICAL HINTS

---

### Baking

- we recommend using the baking trays which were provided with your cooker;
- it is also possible to bake in cake tins and trays bought elsewhere which should be put on the drying rack; for baking it is better to use black trays which conduct heat better and shorten the baking time;
- shapes and trays with bright or shiny surfaces are not recommended when using the conventional heating method (top and bottom heaters), use of such tins can result in undercooking the base of cakes;
- when using the ultra-fan function it is not necessary to initially heat up the oven chamber, for other types of heating you should warm up the oven chamber before the cake is inserted;
- before the cake is taken out of the oven, check if it is ready using a wooden stick (if the cake is ready the stick should come out dry and clean after being inserted into the cake);
- after switching off the oven it is advisable to leave the cake inside for about 5 min.;
- temperatures for baking with the ultra-fan function are usually around 20 – 30 degrees lower than in normal baking (using top and bottom heaters);
- the baking parameters given in Table are approximate and can be corrected based on your own experience and cooking preferences;
- if information given in recipe books is significantly different from the values included in this instruction manual, please apply the instructions from the manual.

### Roasting meat







- cook meat weighing over 1 kg in the oven, but smaller pieces should be cooked on the cooker hob.
- use heatproof ovenware for roasting, with handles that are also resistant to high temperatures;
- when roasting on the drying rack or the grate we recommend that you place a baking tray with a small amount of water on the lowest level of the oven;
- it is advisable to turn the meat over at least once during the roasting time and during roasting you should also baste the meat with its juices or with hot salty water – do not pour cold water over the meat.

# BAKING IN THE OVEN – PRACTICAL HINTS

## ECO heating

















- ECO heating is an optimised heating function designed to save energy when preparing food.
- You cannot reduce the cooking time by setting a higher temperature; preheating the oven is not recommended.
- Do not change the temperature setting and do not open the oven door during cooking.

## Recommended setting for ECO heating

Type of dish	Oven functions	Temperature (°C)	Level	Time in minutes
Sponge cake	 ECO	180 - 200	2 - 3	50 - 70
Yeast cake/ Pound cake	 ECO	180 - 200	2	50 - 70
Fish	 ECO	190 - 210	2 - 3	45 - 60
Beef	 ECO	200 - 220	2	90 - 120
Pork	 ECO	200 - 220	2	90 - 160
Chicken	 ECO	180 - 200	2	80 - 100

## BAKING IN THE OVEN – PRACTICAL HINTS

Oven with automatic air circulation (including a fan and ring heater)

Type of dish	Type of heating	Temperature (°C)	Level	Time (min.)
Sponge cake		160 - 200	2 - 3	30 - 50
Yeast cake/ Pound cake		160 - 170 <sup>1)</sup>	3	25 - 40 <sup>2)</sup>
Yeast cake/ Pound cake		155 - 170 <sup>1)</sup>	3	25 - 40 <sup>2)</sup>
Pizza		200 - 230 <sup>1)</sup>	2 - 3	15 - 25
Fish		210 - 220	2	45 - 60
Fish		160 - 180	2 - 3	45 - 60
Fish		190	2 - 3	60 - 70
Sausages		200 - 220	4	14 - 18
Beef		225 - 250	2	120 - 150
Beef		160 - 180	2	120 - 160
Pork		160 - 230	2	90 - 120
Pork		160 - 190	2	90 - 120
Chicken		180 - 190	2	70 - 90
Chicken		160 - 180	2	45 - 60
Chicken		175 - 190	2	60 - 70
Vegetables		190 - 210	2	40 - 50
Vegetables		170 - 190	3	40 - 50

The times are apply to dish that is placed into a cold oven. For the preheated oven, the times should be reduced by about 5-10 minutes.

<sup>1)</sup> Preheat











<sup>2)</sup> Baking smaller items

Note: The figures given in Tables are approximate and can be adapted based on your own experience and cooking preferences.



## TEST DISHES. According to standard EN 60350-1.

### Baking



Type of dish	Accessory	Level	Type of heating	Temperature (°C)	Baking time <sup>2)</sup> (min.)
Small cakes	Baking tray	4		160 <sup>1)</sup>	29 - 32 <sup>2)</sup>
	Baking tray	4		155 <sup>1)</sup>	31 - 34 <sup>2)</sup>
	Baking tray	3		150 <sup>1)</sup>	34 - 37 <sup>2)</sup>
	Baking tray Roasting tray	2 + 4 2 - baking tray or roasting tray 4 - baking tray		150 <sup>1)</sup>	40 - 43 <sup>2)</sup>
Shortbread	Baking tray	3		150 - 160 <sup>1)</sup>	30 - 40 <sup>2)</sup>
	Baking tray	3		150 - 170 <sup>1)</sup>	25 - 35 <sup>2)</sup>
	Baking tray	3		150 - 170 <sup>1)</sup>	25 - 35 <sup>2)</sup>
	Baking tray Roasting tray	2 + 4 2 - baking tray or roasting tray 4 - baking tray		160 - 175 <sup>1)</sup>	25 - 35 <sup>2)</sup>
Fatless sponge cake	Wire rack + black baking tin diameter 26cm	2		170 - 180 <sup>1)</sup>	38 - 46 <sup>2)</sup>
Apple pie	Wire rack + 2 black baking tins diameter 20cm	2 black baking tins placed after the dia- gonal, back right, front left		180 - 200 <sup>1)</sup>	50 - 65 <sup>2)</sup>

<sup>1)</sup>Preheat 5 minutes, do not use Rapid preheat function.

<sup>2)</sup>The times are apply to dish that is placed into a cold oven.



## TEST DISHES. According to standard EN 60350-1.

### Grilling

Type of dish	Accessory	Level	Type of heating	Temperature (°C)	Time (min.)
White bread toast	Wire rack	4		220 <sup>1)</sup>	3 - 7
Beef burgers	Wire rack + roasting tray (to gather drops)	4 - wire rack 3 - roasting tray		220 <sup>1)</sup>	1st side 13- 18 2nd side 10 - 15

<sup>1)</sup>Preheat for 8 minutes, do not use Rapid preheat function.

### Roasting

Type of dish	Accessory	Level	Type of heating	Temperature (°C)	Time (min.)
Whole chicken	Wire rack + roasting tray (to gather drops)	2 - wire rack 1 - roasting tray		180 - 190	70 - 90
	Wire rack + roasting tray (to gather drops)	2 - wire rack 1 - roasting tray		180 - 190	80 - 100

The times are apply to dish that is placed into a cold oven. For the preheated oven, the times should be reduced by about 5-10 minutes.

## CLEANING AND MAINTENANCE

---

By ensuring proper cleaning and maintenance of your cooker you can have a significant influence on the continuing fault-free operation of your appliance.

**Before you start cleaning, the cooker must be switched off and you should ensure that all knobs are set to the “●”/“0” position. Do not start cleaning until the cooker has completely cooled.**

### Ceramic hob

- The hob should be cleaned regularly after each use. If possible, it is recommended that the hob is washed while still warm (after the heating zone indicator goes off). Do not allow the hob to get heavily stained; particularly from burnt-on spillages from boiled over liquids.
- When cleaning do not use cleaning agents with a strong abrasive effect, such as e.g. scouring powders containing an abrasive, abrasive compounds, abrasive stones, pumice stones, wire brushes and so on. They may scratch the hob surface, causing irreversible damage.
- Large spillages that are firmly stuck to the hob can be removed by a special scraper; but be careful not to damage the ceramic hob frame when doing this.

**Caution! The sharp blade should always be protected by adjusting the cover (just push it with your thumb). Injuries are possible so be careful when using this instrument – keep out of reach of children.**

- Appropriate light cleaning or washing products are recommended, such as e.g. any kind of liquids or emulsions for fat removal. If the recommended products are not available, it is advisable to use a solution of warm water with a little washing-up liquid or cleaning products for stainless steel sinks.

### Oven

- The oven should be cleaned after every use. When cleaning the oven the lighting should be switched on to enable you to see the surfaces better.
- The oven chamber should only be washed with warm water and a small amount of washing-up liquid.
- After cleaning the oven chamber wipe it dry.

### Caution!

Do not use cleaning products containing abrasive materials for the cleaning and maintenance of the glass front panel.

### Caution!

Do not use cleaning products containing abrasive materials for the cleaning and maintenance of the glass front panel.

## CLEANING AND MAINTENANCE

- Ovens are equipped with easily removable wire shelf supports. To remove them for cleaning use size 3 Allen key to undo the fixing screws from shelf support holders. Once cleaned, replace the shelf supports in oven chamber. Before tightening, make sure the shelf support holders are secure in the holes provided in oven chamber wall.

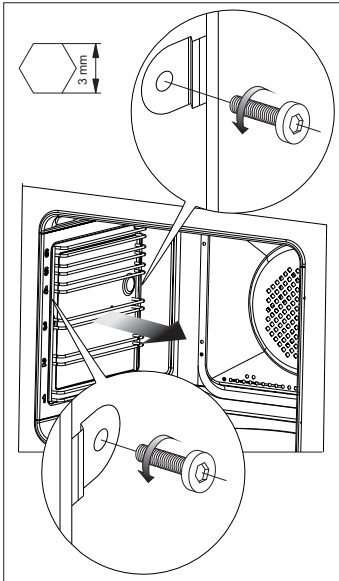

Removing wire shelf supports

### Replacing the halogen bulb in the oven

**Before replacing the halogen bulb, make sure the appliance is disconnected from the electric mains to avoid a possible electric shock.**

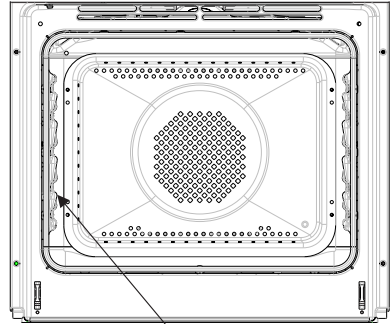

Oven lighting

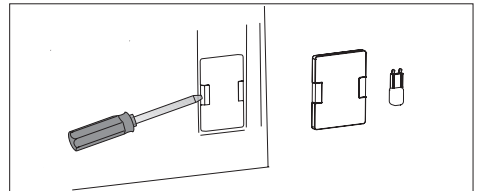

1. Unplug the appliance
2. Remove shelves and trays from the oven.
3. If the oven has telescopic runners, remove them also.
4. Use a flat screwdriver to pry the lamp cover loose, remove it, wash and carefully wipe it dry.
5. Pull the halogen bulb out by sliding it down using a cloth or paper. If necessary, replace the halogen bulb with a new one.
  - voltage 230V
  - power 25W
6. Replace the halogen bulb in its socket.
7. Replace the lamp cover

# CLEANING AND MAINTENANCE

## Pyrolytic cleaning

The oven heats up to a temperature of about 480°C. Grilling or baking residue is burnt into an easy to remove ash that can be wiped off with a damp cloth.

### Before pyrolytic cleaning.

#### **Important!**

Remove all accessories from the oven (baking trays, drying grates, side racks, telescopic runners). Accessories left inside the oven will be irreversibly damaged during the pyrolysis cleaning.

- Remove stubborn stains from the oven chamber.
- Clean the outside of the oven with a damp cloth.
- Follow the instructions.

### During the cleaning process.

- Do not leave the cloth near the hot oven.
- Do not use the hob.
- Do not turn on the oven lighting.
- The oven door is equipped with a lock, which prevents it from being opened during the cleaning process. Do not open the door so as not to interrupt the cleaning process.

#### **Important!**

During the pyrolytic oven cleaning process the oven chamber can reach a very high temperature. Consequently, the appliance outer surfaces can heat up more than usual, so keep children away at all times.

Some fumes can be emitted during the cleaning, so make sure the kitchen is well ventilated.

### The pyrolytic cleaning process:

- Close the oven door.
- Set the function selector knob in position Pyrolytic Cleaning **P**,
- Pyrolytic Cleaning duration (2:00) as well as „auto” and „P” symbols are shown on the display. Door lock indicator light comes on||.



- Touch MENU for approx. 3-4 seconds until the display shows 0.00.

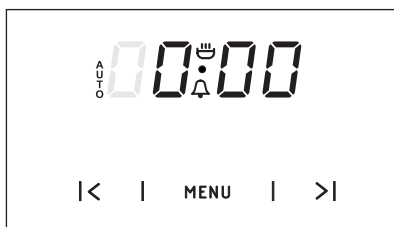

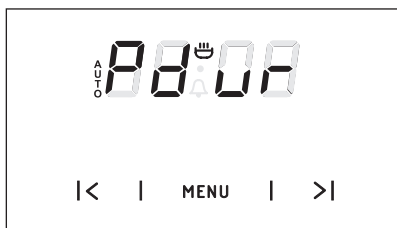

## CLEANING AND MAINTENANCE

- Touch MENU again. The display will flash Pdur.

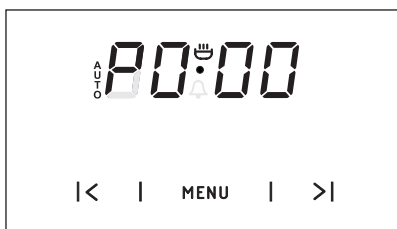

- Touch > or < sensors to select the Duration. You can select 2.00 (2 hours, 120 minutes), 2.30 (2.5 hours, 150 minutes) or 3.00 (3 hours, 180 minutes). Once you have made your choice wait for the acoustic signal which confirms that Duration has been set.
- Pyrolytic cleaning process will start. Oven door will be locked.
- "P0.00" is shown on the display when the pyrolytic cleaning is complete. The appliance will then enter the cooling phase, while still displaying P0:00.



- The doors will be unlocked automatically when the oven chamber cools down. When the temperature inside the oven chamber cools down to 160°C, the door is unlocked and the door lock indicator  light goes out. This can take 45 to 75 minutes after the P0:00 alarm is sounded.
- When door lock indicator light is off, set the function selector knob in position 0.

- When the door is unlocked and you turn off the oven, you can open the door and remove ash with a soft, damp cloth. Replace the side rail and other accessories. Your oven is ready for use. The cooling phase continues until the temperature of 50°C is reached inside the oven cavity.

### Important!

When you start the pyrolytic cleaning process and inadvertently open the oven door, the process will stop and door lock indicator will be flashing. To restart the pyrolytic cleaning turn the selector knob to 0 and re-enter the desired settings.

### Cancel the process

Pyrolytic cleaning is an automatic process that should not be interrupted.

If you need to stop the process, turn the selector knob to position 0.

Depending on the time when you interrupt the process (temperature in the oven chamber) the oven chamber will need to first cool down to 160°C before the door is unlocked.

### Open the door in emergency

If for some reason the door is not unlocked automatically, and the oven chamber has already cooled down, open the door as follows:

- set the function selector knob in position "Lighting",
- wait for 4 minutes;
- set the function selector knob in position 0 – the oven door should unlock within 10 minutes.

**Note. The door will not unlock if the temperature inside the oven chamber is above 160°C.**

## CLEANING AND MAINTENANCE

### Door removal

In order to obtain easier access to the oven chamber for cleaning, it is possible to remove the door. To do this, tilt the safety catch part of the hinge upwards (fig. A). Close the door lightly, lift and pull it out towards you. In order to fit the door back on to the cooker, do the inverse. When fitting, ensure that the notch of the hinge is correctly placed on the protrusion of the hinge holder. After the door is fitted to the oven, the safety catch should be carefully lowered down again. If the safety catch is not set it may cause damage to the hinge when closing the door.

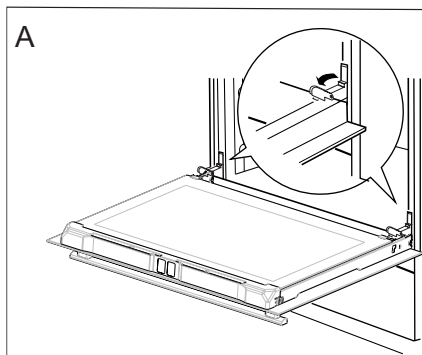

*Tilting the hinge safety catches*

### Removing the inner panel

1. Using a cross-head screwdriver undo the screws in the upper door slat (fig. B).
2. Using a flat screwdriver remove the upper door slat, prying it gently on the sides (fig. B, C).

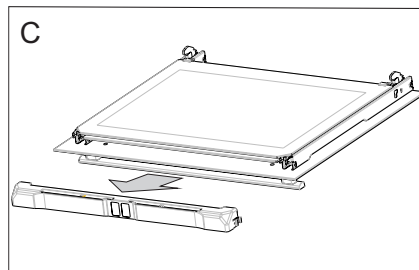
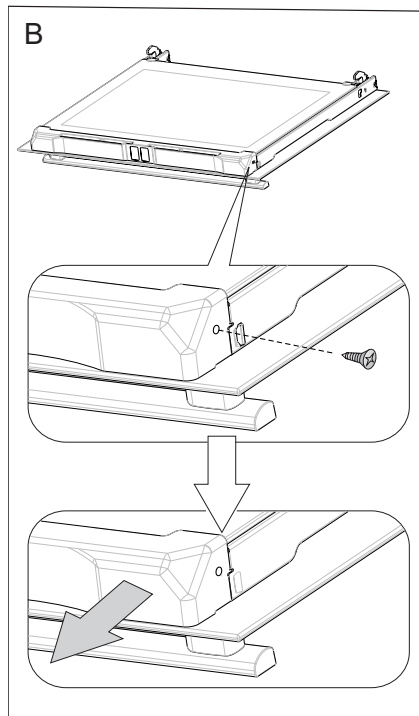

## CLEANING AND MAINTENANCE

---

3. Pull the inner glass panel from its seat (in the lower section of the door).

**Important! Risk of damage to glass panel mounting. Do not lift the glass panel up but pull it out.**

Remove the inner panel (fig. D).

4. Clean the panel with warm water with some cleaning agent added.

Carry out the same in reverse order to reassemble the inner glass panel. Its smooth surface shall be pointed upwards.

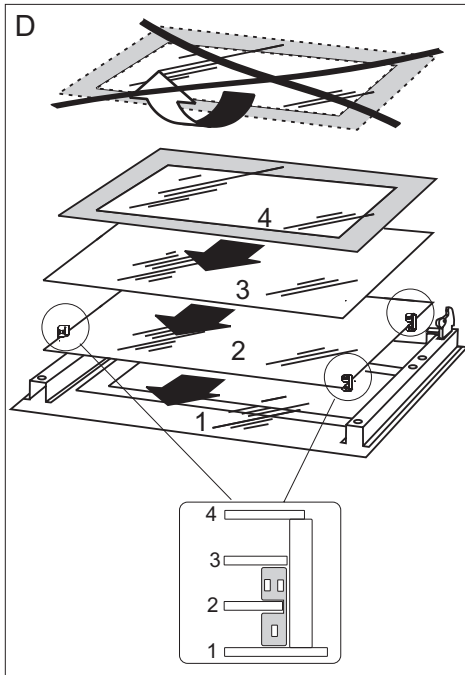

*Removal of the internal glass panel*



# CLEANING AND MAINTENANCE

---

## ▶ Regular inspections

Besides keeping the cooker clean, you should:

- carry out periodic inspections of the control elements and cooking units of the cooker. After the guarantee has expired you should have a technical inspection of the cooker carried out at a service centre at least once every two years,
- fix any operational faults,
- carry out periodical maintenance of the cooking units of the cooker.

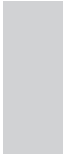

### Caution!

All repairs and regulatory activities should be carried out by the appropriate service centre or by an appropriately authorised fitter.

## OPERATION IN CASE OF EMERGENCY

---

In the event of an emergency, you should:

- switch off all working units of the cooker
- disconnect the mains plug
- call the service centre
- some minor faults can be fixed by referring to the instructions given in the table below.

Before calling the customer support centre or the GRAM service centre check the following points that are presented in the table.

PROBLEM	REASON	ACTION
The appliance does not work.	break in power supply	check the household fuse box, if there is a blown fuse replace it with a new one
The oven lighting does not work	the bulb is loose or damaged	tighten up or replace the blown bulb (see Chapter <i>Cleaning and Maintenance</i> )

## TECHNICAL DATA

---



Voltage rating	230V~50 Hz
Power rating	max. 11,0 kW
Cooker dimensions H/W/D	90 / 60 / 60,5 cm

### Basic Information:

The product meets the requirements of European standards EN 60335- 1; EN60335-2-6.

The data on the energy labels of electric ovens is given according to standard EN 60350-1 / IEC 60350-1. These values are defined with a standard workload a with the functions active: bottom and top heaters (conventional heating) and fan assisted heating (forced air heating), if these functions are available.

The energy efficiency class was assigned depending on the function available in the product in accordance with the priority below:

Forced air circulation ECO (ring heater + fan)	 ECO
Forced air circulation ECO (bottom heater + top + roaster + fan)	 ECO
Conventional mode ECO (bottom heater + top)	 ECO

During energy consumption test, remove the telescopic runners (if the product is fitted with any).



**NO:**

**Gram A/S**

Tel.: 22 07 26 30

[www.gram.no](http://www.gram.no)

**SE:**

**Gram A/S**

Tel.: 040 38 08 40

[www.gram.se](http://www.gram.se)

**FI:**

**Gram A/S**

Tel.: 020 7756 350

[www.gram.fi](http://www.gram.fi)



Gram A/S

Gejlhavegård 2B

DK-6000 Kolding

+45 73 20 10 00

[www.gram.dk](http://www.gram.dk)

IO-CFS-1481 / 8507721

(01.2020 V2)