



DA	Ovn
EN	Oven
FI	Uuni
NO	Ovn
SV	Inbyggadsugn

Brugsanvisning	2
User Manual	41
Käyttöohje	80
Bruksanvisning	120
Bruksanvisning	159



VI TÆNKER PÅ DIG

Tak fordi du købte et Electrolux-apparat. Du har valgt et produkt, som giver dig årtiers professionel erfaring og innovation. Genialt og elegant. Det er designet med dig i tankerne. Så uanset hvornår du bruger den, kan du være sikker på, at du får fantastiske resultater hver gang. Velkommen til Electrolux.

Besøg vores hjemmeside for at:



få rådgivning, brochurer, fejlfinding, service- og reparationsinformation:
www.electrolux.com/support



Registrér dit produkt for at få bedre service:
www.registerelectrolux.com



Køb tilbehør, forbrugsvarer og originale reservedele til dit apparat:
www.electrolux.com/shop



Hent **My Electrolux Kitchen**-appen for flere opskrifter, tips og fejlfinding.



KUNDEPLEJE OG SERVICE

Brug altid originale reservedele.

Sørg for at have følgende data klar, når du kontakter vores autoriserede servicecenter: Model, PNC, serienummer.

Oplysningerne findes på typeskiltet.

 Advarsel/forsigtig-sikkerhedsanvisninger

 Generelle oplysninger og råd

 Miljøoplysninger

Ret til ændringer uden varsel forbeholdes.

INDHOLDSFORTEGNELSE

1. OM SIKKERHED	4	3. PRODUKTBESKRIVELSE	8
1.1 Sikkerhed for børn og sårbare personer.....	4	3.1 Generelt overblik.....	9
1.2 Generel sikkerhed.....	4	3.2 Tilbehør.....	9
2. SIKKERHEDSANVISNINGER	5	4. SÅDAN TÆNDES OG SLUKKES	
2.1 Installation.....	5	OVNEN	10
2.2 El-forbindelse.....	6	4.1 Forsænkbare knapper.....	10
2.3 Brug.....	7	4.2 Betjeningspanel.....	10
2.4 Vedligeholdelse og rengøring.....	8	5. FØR BRUG FØRSTE GANG	12
2.5 Indvendig belysning.....	8	5.1 Indledende rengøring.....	12
2.6 Service.....	8	5.2 Indledende forvarmning.....	12
2.7 Bortskaffelse.....	8	5.3 Trådløs forbindelse 	12
		5.4 Softwarelicenser.....	13

6. DAGLIG BRUG.....	13	10.2 Fugtig varmluft - anbefalet tilbehør.....	29
6.1 Sådan indstilles: Ovnfunktioner.....	14	10.3 Madlavningstabeller for testinstitutter.....	29
6.2 Ovnfunktioner.....	14		
6.3 Bemærkninger til: Fugtig varmluft..	16		
6.4 Sådan indstilles: Hjælp til tilberedning.....	16		
6.5 Hjælp til tilberedning med opskrifter.....	17		
7. URFUNKTIONER.....	21	11. VEDLIGEHOLDELSE OG RENGØRING.....	31
7.1 Urfunktioner.....	22	11.1 Bemærkninger om rengøring.....	31
7.2 Sådan indstilles: Urfunktioner.....	22	11.2 Rengøring: Prægning i ovnrum.....	32
8. ANVENDELSE: TILBEHØR.....	23	11.3 Fjernelse: Ovnribber	32
8.1 Isætning af tilbehør.....	23	11.4 Anvendelse: Katalyserengøring ..	32
8.2 Termometer.....	24	11.5 Fjernelse og installation: Låge.....	33
9. EKSTRAFUNKTIONER.....	26	11.6 Udskiftning: Lampe.....	34
9.1 Lås.....	26	12. FEJLFINDING.....	35
9.2 Automatisk slukning.....	26	12.1 Hvad gør du, hvis	35
9.3 Køleventilator.....	26	12.2 Serviceoplysninger.....	37
9.4 Mekanisk lågelås.....	27	13. ENERGIEFFEKTIV.....	37
9.5 Anvendelse: Mekanisk lågelås.....	27	13.1 Produktinformation og produktinformationsark*.....	37
10. RÅD OG TIPS.....	28	13.2 Energibesparelse.....	38
10.1 Fugtig varmluft.....	28	14. MENUSTRUKTUR.....	38
		14.1 Menu.....	39

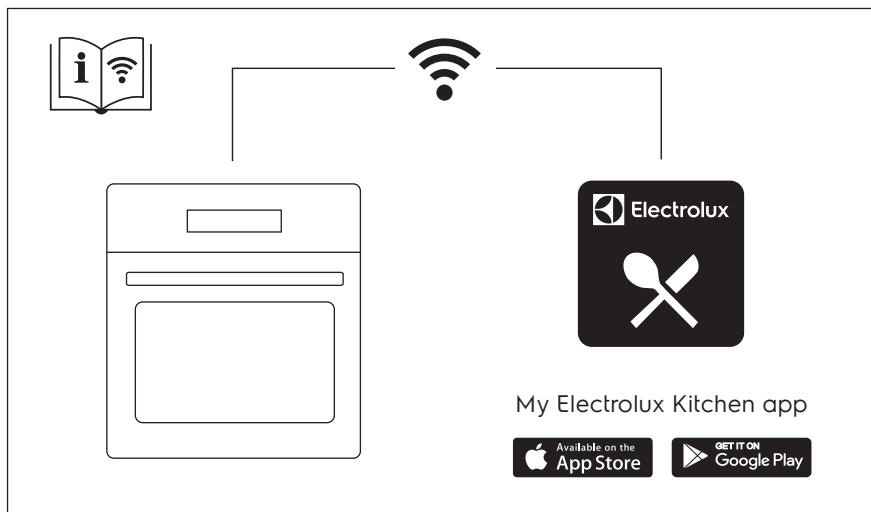

1. ⚠️ OM SIKKERHED

Læs brugsanvisningen grundigt, før apparatet installeres og tages i brug. Producenten påtager sig intet ansvar for eventuelle skader, der er resultatet af forkert installation eller brug. Opbevar altid brugsanvisningen på et sikkert og tilgængeligt sted til senere opslag.

1.1 Sikkerhed for børn og sårbare personer

- Apparatet må kun bruges af børn fra 8 år og opefter samt af personer med nedsat fysisk, sensorisk eller psykisk funktionsevne, eller som mangler den nødvendige erfaring eller viden, hvis de er under opsyn eller er blevet instrueret i at bruge apparatet på en sikker måde samt forstår de farer, det indebærer. Børn under 8 år og personer med omfattende og komplekst handicap skal holdes på afstand af apparatet, medmindre de overvåges konstant.
- Børn skal holdes under opsyn for at sikre, at de ikke leger med apparatet og mobile enheder med My Electrolux Kitchen.
- Opbevar al emballage utilgængeligt for børn, og bortskaf det korrekt.
- ADVARSEL: Lad ikke børn og husdyr komme tæt på apparatet, når det er i drift, eller mens det køler af. Tilgængelige dele bliver meget varme under brug.
- Hvis apparatet har en børnesikring, skal den aktiveres.
- Børn må ikke udføre rengøring og vedligeholdelse på produktet uden opsyn.

1.2 Generel sikkerhed

- Kun en faguddannet installatør må installere apparatet og udskifte kablet.
- Brug ikke apparatet, inden det monteres i den indbyggede struktur.

- Før enhver vedligeholdelse skal apparatet kobles fra elnettet.
- Hvis strømforsyningskablet er beskadiget, skal det af sikkerhedsmæssige grunde udskiftes af producenten, et autoriseret servicecenter eller en tekniker for at undgå elektrisk stød.
- **ADVARSEL:** Se efter, at der er slukket for apparatet, inden pæren skiftes. Ellers er der risiko for elektrisk stød.
- **ADVARSEL:** Apparatet og de tilgængelige dele bliver meget varme under brug. Pas på ikke at røre varmelegemerne.
- Brug altid ovnhandsker til at tage ribber eller ovnfaste fade ud eller sætte dem i.
- Brug kun den anbefalede temperaturføler (termometer) til dette apparat.
- For at fjerne ovnribberne skal du først trække ovnribbens forende og derefter dens bagende væk fra sidevæggene. Montér ovnribberne i omvendt rækkefølge.
- Undlad at bruge en damprenser til at rengøre apparatet.
- Brug ikke skrappe slibende rengøringsmidler eller skarpe metalskrabere til at rengøre ovnruden. De kan ridse overfladen, med det resultat, at glasset knuses.

2. SIKKERHEDSANVISNINGER

2.1 Installation

**ADVARSEL!**

Apparatet må kun installeres af en sagkyndig.

- Fjern al emballagen.
- Undlad at installere eller bruge et beskadiget apparat.
- Følg installationsvejledningen, der følger med apparatet.
- Vær altid forsigtig, når du flytter apparatet, da det er tungt. Brug altid sikkerhedshandsker og lukket fodtøj.
- Træk aldrig i apparatet i håndtaget.
- Installér apparatet et sikkert og velegnet sted, der opfylder installationskrav.
- Mindsteafstanden til andre apparater og enheder skal overholdes.
- Før montering af apparatet kontrolleres, om ovnlugen åbner uden modstand.
- Apparatet er udstyret med et elektrisk afkølingssystem. Det skal betjenes med den elektriske strømforsyning.
- Indbygningsskabets stabilitet skal opfylde kravene i DIN 68930.

Kabinetets minimumshøjde (kabinets minimumshøjde under bordpladen)	578 (600) mm
Kabinet, bredde	560 mm
Kabinet, dybde	550 (550) mm
Højde foran på apparatet	594 mm
Højde bagest på apparatet	576 mm
Bredde foran på apparatet	595 mm
Bredde bagest på apparatet	559 mm
Apparatets dybde	567 mm
Apparatets indbygningsdybde	546 mm
Dybde med åben dør	1027 mm
Ventilationsåbning minimumsstørrelse. Åbning placeret på bundens bageste side	560 x 20 mm
Længden på ledninger til strømforsyning. Ledning placeret i højre hjørne af bagsiden	1500 mm
Monteringsskruer	4 x 25 mm

2.2 El-forbindelse



ADVARSEL!

Risiko for brand og elektrisk stød.

- Alle elektriske tilslutninger skal udføres af en kvalificeret elektriker.
- Apparatet skal tilsluttes strøm m/jord, jvf. Stærkstrømsreglementet.
- Sørg for, at parametrene på typeskiltet er kompatible med nettilslutningens elektriske mærkeværdier.
- Brug altid en korrekt monteret lovlig stikkontakt.
- Brug ikke multistikadaptere og forlængerledninger.
- Pas på, du ikke beskadiger netstikket og netledningen. Hvis der bliver behov for at udskifte netledningen, skal det udføres af vores autoriserede servicecenter.
- Elledninger må ikke komme i berøring med eller nær ved apparatets låge, især når det er tændt, eller lågen er varm.
- Beskyttelsen mod elektrisk stød fra strømførende og isolerede dele skal fastgøres, så den ikke kan fjernes uden værktøj.

- Sæt først netstikket i stikkontakten ved installationens afslutning. Sørg for, at der er adgang til elstikket efter installationen.
- Hvis stikkontakten er løs, må du ikke sætte netstikket i.
- Undgå at slukke for apparatet ved at trække i netledningen. Tag altid selve netstikket ud af kontakten.
- Brug kun korrekte isoleringsenheder: Gruppeafbrydere, sikringer (sikringer med skruegevind skal tages ud af fatningen), fejlstrømsrelæer og kontaktorer.
- Apparats installation skal udføres med et isolationsudstyr, så forbindelsen til lysnettet kan afbrydes på alle poler. Isolationsudstyret skal have en brydeafstand på mindst 3 mm.
- Dette apparat er forsynet med et stik og en strømledning.

2.3 Brug



ADVARSEL!

Risiko for personskade, forbrændinger og elektrisk stød eller eksplosion.

- Dette apparat er kun til husholdningsbrug (indendørs).
- Apparats specifikationer må ikke ændres.
- Sørg for, at ventilationsåbningerne ikke er blokerede.
- Lad ikke apparatet være uden opsyn under drift.
- Sluk for apparatet efter hver brug.
- Vær forsigtig, når du åbner apparats låge, hvis apparatet er i brug. Der kan slippe varm luft ud.
- Betjen ikke apparatet med våde hænder, eller når det har kontakt med vand.
- Tryk ikke på den åbne låge.
- Brug ikke apparatet som arbejds- eller fræsætningsplads.
- Åbn apparats låge forsigtigt. Brug af ingredienser med alkohol kan forårsage en blanding af alkohol og luft.
- Lad ikke gnister eller åben ild komme i kontakt med apparatet, når du åbner lågen.
- Læg ikke brændbare produkter eller genstande, der er våde med brændbare produkter i nærheden af eller på apparatet.
- Del ikke din Wi-Fi-adgangskode.



ADVARSEL!

Risiko for beskadigelse af apparatet.

- Sådan undgås skader eller misfarvning af emaljen:
 - Stil ikke ovnfaste fæde eller andre genstande direkte i apparatet.
 - Læg ikke aluminiumsfolie direkte på bunden af ovnrummet.
 - Hæld ikke vand direkte ind i det varme apparat.
 - Hold ikke fugtige fæde og madvarer i apparatet, når du har afsluttet tilberedningen.
 - Vær forsigtig, når du fjerner eller monterer tilbehøret.
- Farveændring af emaljen eller rustfrit stål forringer ikke apparats ydeevne.
- Brug en bradepande til fugtige kager. Frugtsaft forårsager pletter, der kan være permanente.
- Dette apparat må kun anvendes til tilberedning af fødevarer. Det må ikke bruges til andre formål, f.eks. rumopvarmning.
- Hold altid ovnlågen lukket under tilberedningen.
- Hvis apparatet installeres bag et møbelpanel (f.eks. en dør), skal du sørge for, at døren aldrig lukkes, mens apparatet er tændt. Der kan opbygges varme og fugt bag et lukket

PRODUKTBEKRIVELSE

møbelpanel, hvilket kan forårsage efterfølgende skade på apparatet, huset eller gulvet. Luk ikke møbelpanelet, før apparatet er kølet helt af efter brug.

2.4 Vedligeholdelse og rengøring



ADVARSEL!

Risiko for personskade, brand eller skade på apparatet.

- Sluk for apparatet, og tag stikket ud af kontakten inden vedligeholdelse.
- Kontrollér, at apparatet er kølet af. Der er risiko for, at ovnglasset går i stykker.
- Udskift øjeblikkeligt ovnglassets paneler, hvis de er beskadigede. Kontakt det autoriserede servicecenter.
- Vær forsigtig, når du tager lågen af apparatet. Døren er tung!
- Rengør jævnligt apparatet for at forhindre forringelse af overfladematerialet.
- Rengør apparatet med en fugtig, blød klud. Brug kun neutrale rengøringsmidler. Brug ikke slibende midler, skuresvampe, opløsningsmidler eller metalgenstande.
- Hvis du bruger en ovnspray, skal du følge instruktionerne på dens emballage.
- Undgå at rengøre den katalytiske emalje med rengøringsmidler.

2.5 Indvendig belysning



ADVARSEL!

Risiko for elektrisk stød.

- Vedrørende lampe(rne) i dette produkt og reservedelslamper, der sælges separat: Disse lamper er beregnet til at modstå ekstreme fysiske forhold i husholdningsapparater, såsom temperatur, vibration, fugt, eller er beregnet til at signalere information om apparatets driftsstatus. De er ikke beregnet til at blive brugt i andre apparater, og de er ikke velegnede til belysning af rum.
- Brug kun lamper med de samme specifikationer.

2.6 Service

- Kontakt det autoriserede servicecenter for at få repareret apparatet.
- Brug kun originale reservedele.

2.7 Bortskaffelse



ADVARSEL!

Risiko for personskade eller kvælning.

- Tag stikket ud af kontakten.
- Klip netledningen af tæt ved apparatet og bortskaf den.
- Fjern lågelåsen for at forhindre, at børn eller kæledyr bliver fanget i apparatet.

3. PRODUKTBEKRIVELSE

3.1 Generelt overblik

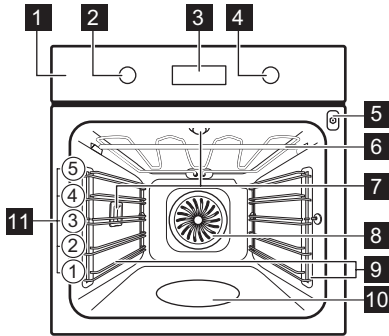

- 1** Betjeningspanel
- 2** Knap til ovnfunktioner
- 3** Display
- 4** Betjeningsknap
- 5** Stik til termometer
- 6** Varmelegeme
- 7** Ovn-pære
- 8** Blæser
- 9** Ovnribbe, udtagelig
- 10** Ovnrumsprægning
- 11** Ovnriller

3.2 Tilbehør

Grillrist

Til kogegrej, kageforme, stege.

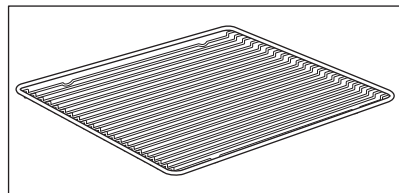

SÅDAN TÆNDES OG SLUKKES OVNEN

Bageplade

Til kager og småkager.

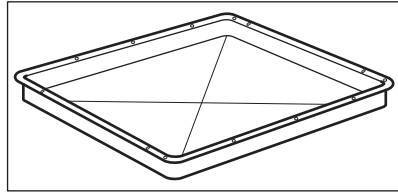

Grill-/bradepande

Til at bage og stege eller som en pande til opsamling af fedt.

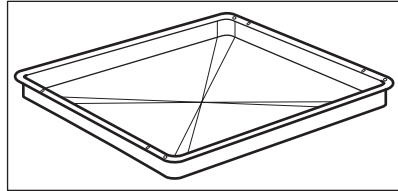

Professionelle plader

Til boller, kringler og småkager. Velegnet til dampfunktioner. Misfarvning af overfladen har ingen indvirkning på funktionerne.

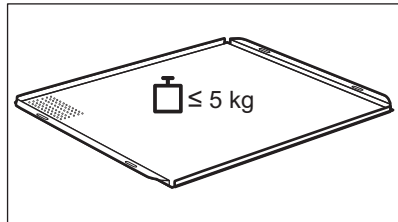

Termometer

Til måling af temperaturen i maden.

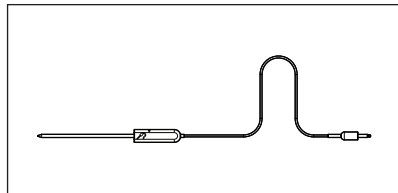







4. SÅDAN TÆNDES OG SLUKKES OVNEN

4.1 Forsænkbare knapper

Tryk på funktionsvælgeren for at bruge apparatet. Funktionsvælgeren kommer ud.









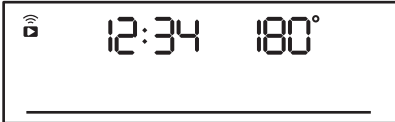
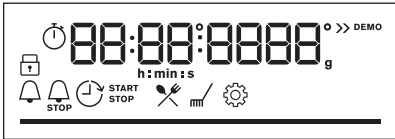

4.2 Betjeningspanel

Sensorfelter til betjeningspanelet					Tryk	Drej knappen
 Timer	 Hurtig opvarmning	 Lys	 Termometer	OK		

SÅDAN TÆNDES OG SLUKKES OVNER



Sensorfelter til betjeningspanelet	Tryk	Drej knappen
Vælg en ovnfunktion for at tænde ovnen.		
Drej knappen for ovnfunktionerne til sluk-positionen for at slukke for ovnen.		

	Når knappen for ovnfunktionerne er i sluk-positionen, skifter displayet til standby.
	Når du laver mad, viser displayet den indstillede temperatur, aktuel tid og andre tilgængelige tilvalg.
	Displayet med det højeste antal funktioner indstillet.

Displaylamper				
 Lås	 Hjælp til tilberedning	 Rengøring	 Indstillinger	 Hurtig opvarmning
Indikatorer for timer:				
Wi-Fi indikator - blinker, når ovnen kan tilsluttes Wi-Fi.		Fjernbetjent tilstand indikator - ovnen kan fjernbetjenes.		
 Wi-Fi forbindelsen er slået til.		 Fjernbetjent tilstand er tændt.		

Statuslinje - til temperatur eller tid.	
--	---

FØR BRUG FØRSTE GANG

Indikator for damptilberedning	
Termometer Indikator	

5. FØR BRUG FØRSTE GANG



ADVARSEL!

Se kapitlerne om sikkerhed.

5.1 Indledende rengøring

Inden den første brug rengøres den tomme ovn og tiden indstilles:



00:00

Indstil tid. Tryk på: OK

5.2 Indledende forvarmning



Forvarm den tomme ovn, inden du tager den i brug.

Trin 1 Fjern al tilbehøret og de udtagelige ovnribber fra ovnen.

Trin 2 Indstil den maksimale temperatur for funktionen: .
Lad ovnen være tændt i 1 time.

Trin 3 Indstil den maksimale temperatur for funktionen: .
Lad ovnen være tændt i 15 min.

 Ovnene kan udsende lugt og røg under forvarmning. Kontroller, at rummet er udluftet.

5.3 Trådløs forbindelse

For at tilslutte ovnen skal du bruge:

- Et trådløst netværk med internetforbindelsen.
- En mobil enhed sluttet til dit trådløse netværk.

Trin 1 Download Mobile App'en My Electrolux Kitchen, og følg vejledningen til de næste trin.

Trin 2	Drej knappen for at vælge:  .
---------------	--

Frekvens	2,4 Ghz WLAN	5 Ghz WLAN
	2400 - 2483,5 Mhz	5150 - 5350 MHz 5470 - 5725 MHz
Protokol	IEEE 802.11b DSSS/ 802.11g/n OFDM	IEEE 802.11 a/n OFDM
Maks. effekt	EIRP < 20 dBm (100 mW)	EIRP < 23 dBm (200 mW)
Wi-fi-modul	NIU5-50	

Frekvens Bluetooth	2400 - 2483,5 Mhz
Protokol	LE: DSSS
Maks. effekt	EIRP < 4 dBm (2,5 mW)

EU-medlemslandene dækket af bestemmelse af direktiv 2014/53/EU: Belgien, Bulgarien, Tjekkiet, Danmark, Tyskland, Estland, Irland, Grækenland, Spanien, Frankrig, Kroatien, Italien, Cypern, Letland, Litauen, Luxemburg, Ungarn, Malta, Holland, Østrig, Polen, Portugal, Rumænien, Slovenien, Slovakiet, Finland, Sverige, Norge, Schweiz, Storbritannien, Tyrkiet.



5.4 Softwarelicenser



<p>Softwaren i dette produkt indeholder komponenter, som er baseret på fri og open source-software. Electrolux at anerkende bidrag fra de åbne software- og robotgrupper til udviklingsprojektet.</p>
<p>For at få adgang til kildekoden for disse gratis og åbne kildesoftwarekomponenter, hvis licensbetingelser kræver offentliggørelse, og for at se deres fulde oplysninger om copyright og gældende licensbetingelser, bedes du gå ind på: http://electrolux.opensoftwarerepository.com (mappe NIU5).</p>

6. DAGLIG BRUG

 <p>ADVARSEL! Se kapitlerne om sikkerhed.</p>
--

6.1 Sådan indstilles: Ovnfunktioner

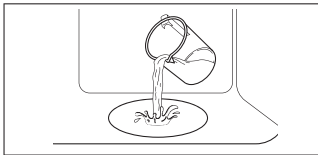







Start tilberedning	
Trin 1	Trin 2
	
Indstil en ovnfunktion.	Indstil temperaturen.

Tilberedning med damp			
Sørg for, at ovnen er kold.			
Trin 1	Trin 2	Trin 3	Trin 4
			Opvarm den tomme ovn i 10 minutter for at skabe fugt. Sæt mad i ovnen.
Fyld fordybningen i ovnrummet med vand.	Vælg dampovnfunktion.	Indstil temperaturen.	
<p>i Der kan maks. være 250 ml i fordybningen i ovnrummet. Fyld ikke fordybningen i ovnrummet under tilberedning, eller når ovnen er meget varm.</p>			

Når damptilberedningen slutter:		
Trin 1	Trin 2	Trin 3
Drej knappen for ovnfunktionerne til sluk-positionen for at slukke for ovnen.	Åbn forsigtigt lågen. Frigivet fugt kan forårsage forbrændinger.	Sørg for, at ovnen er kold. Fjern det resterende vand fra fordybningen i ovnrummet.

6.2 Ovnfunktioner

Standardovnfunktioner

Ovnfunktion	Applikation
 Varmluft	<p>Bagning på op til tre ovnriller samtidig og til tørring af fødevarer. Indstil temperaturen 20 - 40 °C lavere end ved Over-/undervarme.</p>
 Over-/undervarme	<p>Til bagning og stegning af mad på én ovnrille.</p>
 SteamBake	<p>Til at tilføje fugtighed under madlavningen. Til at opnå den rette farve og sprøde skorpe under bagning. Til at give større saftighed under genopvarmning. Til henkogning af frugt og grøntsager.</p>
 Pizza	<p>Til at bage pizza. Til at lave en kraftig bruning og en sprød bund.</p>
 Undervarme	<p>Til bagning af kager med sprød bund og til henkogning.</p>
 Frosne madvarer	<p>Til tilberedning af sprøde færdigretter (f.eks. pommes frites, kartoffelbåde eller forårsruller).</p>
 Fugtig varmluft	<p>Denne funktion er beregnet til at spare energi under madlavning. Når du bruger denne funktion, kan temperaturen i ovnrummet variere fra den indstillede temperatur. Restvarmen anvendes. Varmeeffekten kan blive reduceret. Få flere oplysninger i kapitlet "Daglig brug", Bemærkninger til: Fugtig varmluft.</p>
 Grillstegning	<p>Til grillstegning af tynde stykker mad og til ristning af brød.</p>
 Turbogrill	<p>Til stegning af større stykker kød eller fjerkræ med ben på én hyldeposition. For at lave gratiner og til at brune.</p>

Ovnfunktion	Applikation
 Menu	For at åbne menuen: Hjælp til tilberedning, Rengøring, Indstillinger.

6.3 Bemærkninger til: Fugtig varmluft

Denne funktion blev anvendt til at overholde kravene i energieffektivitetsklasse og økodesign i overensstemmelse med EU 65/2014 og EU 66/2014. Test i henhold til EN 60350-1.

Ovnlågen skal være lukket under tilberedningen, så funktionen ikke afbrydes, og ovnen kører med den højeste energieffektivitet, der er mulig.





Når du bruger denne funktion, slukkes lampen automatisk efter 30 sekunder.

Se kapitlet "Råd" for at få oplysninger om tilberedningsvejledningen. Fugtig varmluft. Se kapitlet "Energieffektivitet", Energibesparelse for generelle anbefalinger til energibesparelse.





6.4 Sådan indstilles: Hjælp til tilberedning

Hver ret i denne undermenu har en anbefalet funktion og temperatur. Du kan justere tiden og temperaturen under tilberedningen.







Til nogle retter kan du også tilberede med:	Den grad, en ret tilberedes ved:
<ul style="list-style-type: none"> • Termometer 	<ul style="list-style-type: none"> • Rød • Medium • Gennemstegt







Hjælp til tilberedning - brug den til at tilberede en ret hurtigt med standardindstillingerne:			
Trin 1	Trin 2	Trin 3	Trin 4
			
Åbn menuen.	Vælg Hjælp til tilberedning. Tryk på OK.	Vælg retten. Tryk på: OK	Sæt retten i ovnen. Bekræft indstillingen.



















6.5 Hjælp til tilberedning med opskrifter

Forklaring	
	Termometer tilgængelig. Anbring Termometer i den tykkeste del af retten. Ovnens slukkes, når den indstillede Termometer temperatur er nået.
	Mængden af vand til dampfunktionen.
	Forvarm ovnen, inden du begynder at lave mad.
	Ribbe.





























Når funktionen slutter, skal du kontrollere, om maden er klar.























	Ret	Vægt	Ribbe/Tilbehør	Varighed
Oksekød 🍖				
P1	Roastbeef, rød	1 - 1,5 kg; 4 - 5 cm tykke stykker	  2; bageplade Steg kødet i nogle få minutter på en varm pande. Sæt det i ovnen.	~ 40 min
P2	Roastbeef, rosa i midten			~ 50 min
P3	Roastbeef, gennemstegt			~ 60 min
P4	Steak, medium	180 - 220 g pr. stk., 3 cm tykke skiver	   3; stegefad på grillrist Steg kødet i nogle få minutter på en varm pande. Sæt det i ovnen.	~ 15 min
P5	Oksesteg / braiseret (højreb, øverste rund, tyk flanksteak)	1,5 - 2 kg	  2; stegefad på grillrist Steg kødet i nogle få minutter på en varm pande. Tilsæt væske. Sæt det i ovnen.	~ 120 min

	Ret	Vægt	Ribbe/Tilbehør	Varighed
P6	Roastbeef, rød (lavtemperaturstegning)	1 - 1,5 kg; 4 - 5 cm tykke stykker	 2; bageplade Brug dine yndlingskrydderier eller blot salt og friskkværnet peber. Steg kødet i nogle få minutter på en varm pande. Sæt det i ovnen.	~ 75 min
P7	Roastbeef, medium (lavtemperaturstegning)			~ 85 min
P8	Roastbeef, gennemstegt (lavtemperaturstegning)			~ 130 min
P9	Filet, rød (lavtemperaturstegning)	0,5 - 1,5 kg; 5 - 6 cm tykke stykker	 2; bageplade Brug dine yndlingskrydderier eller blot salt og friskkværnet peber. Steg kødet i nogle få minutter på en varm pande. Sæt det i ovnen.	~ 75 min
P10	Filet, medium (lavtemperaturstegning)			~ 90 min
P11	Filet, færdig (lavtemperaturstegning)			~ 120 min
Kalvekød 				
P12	Kalvesteg (f.eks. bov)	0,8 - 1,5 kg; 4 cm tykke stykker	 2; stegefad på grillrist Brug dine yndlingskrydderier. Tilsæt væske. Tildækket steg.	~ 80 min
Svinekød 				
P13	Nakkesteg i nakkesteg	1,5 - 2 kg	 2; stegefad på grillrist Vend kødet efter halvdelen af tilberedningstiden.	~ 120 min
P14	Pulled pork LTC	1,5 - 2 kg	 2; bageplade Brug dine yndlingskrydderier. Vend kødet efter halvdelen af tilberedningstiden for at få en ensartet bruning.	~ 215 min

	Ret	Vægt	Ribbe/Tilbehør	Varighed
P15	Mørbrad, frisk	1 - 1,5 kg; 5 - 6 cm tykke stykker	  2; stegefad på grillrist Brug dine yndlingskrydderier.	~ 55 min
P16	Spareribs	2 - 3 kg; brug rå, 2 - 3 cm tynde spareribs	 3; bradepande Tilsæt væske for at dække bunden af retten. Vend kødet efter halvdelen af tilberedningstiden.	90 min
Lammekød 				
P17	Lammeben med ben	1,5 - 2 kg; 7 - 9 cm tykke stykker	  2; stegefad på bageplade Tilsæt væske. Vend kødet efter halvdelen af tilberedningstiden.	~ 130 min
Fjerkræ 				
P18	Hel kylling	1 - 1,5 kg; frisk	  2;  200 ml; sammenkogt ret på bageplade Brug dine yndlingskrydderier. Vend kyllingen efter halvdelen af tilberedningstiden for at få en ensartet bruning.	~ 60 min
P19	Halv kylling	0,5 - 0,8 kg	  3; bageplade Brug dine yndlingskrydderier.	~ 40 min
P20	Kyllingebryst	180 - 200 g pr. stk.	   2; sammenkogt ret på grillrist Brug dine yndlingskrydderier. Steg kødet i nogle få minutter på en varm pande.	~ 25 min
P21	Kyllingelår, friske	-	  3; bageplade Hvis du marinerede kyllingelår først, skal du indstille den lavere temperatur og tilberede dem længere.	~ 30 min
P22	And, hel	2 - 3 kg	  2; stegefad på grillrist Brug dine yndlingskrydderier. Læg kødet på stegefadet. Vend anden efter halvdelen af tilberedningstiden.	~ 100 min





DAGLIG BRUG

	Ret	Vægt	Ribbe/Tilbehør	Varighed
P23	Gås, hel	4 - 5 kg	  2; bradepande Brug dine yndlingskrydderier. Læg kødet på bradepanden. Vend gås efter halvdele af tilberedningstiden.	~ 110 min
Andet 				
P24	Farsbrød	1 kg	  2; grillrist Brug dine yndlingskrydderier.	~ 60 min
 Fisk				
P25	Hel fisk, grillstegt	0,5 - 1 kg pr. fisk	  2; bageplade Fyld fisken med smør, og brug dine yndlingskrydderier og krydderurter.	~ 30 min
P26	Fiskefilet	-	  3; sammenkogt ret på grillrist Brug dine yndlingskrydderier.	20 min
Bagning/dessurter   				
P27	Cheesecake	-	 2;  28 cm springform på grillrist	90 min
P28	Æblekage	-	 2;  100 - 150 ml; bageplade	60 min
P29	Æbletærte	-	 2; tærte til grillrist	40 min
P30	Æbletærte	-	 2;  100 - 150 ml;  22 cm tærteform på grillrist	60 min
P31	Brownies	2 kg	 3; bradepande	30 min
P32	Chokolademuffins	-	 2;  100 - 150 ml; muffinbakke på grillrist	30 min
P33	Brødkage	-	 2; brødplade på grillrist	50 min
Grøntsager/tilbehør   				



	Ret	Vægt	Ribbe/Tilbehør	Varighed
P34	Bagte kartofler	1 kg	 2; bageplade Læg de hele kartofler med skindet på bagepladen.	50 min
P35	Kartoffelbåde	1 kg	 3; bageplade foret med bagepapir Brug dine yndlingskrydderier. Skær kartoflerne i stykker.	35 min
P36	Grillede blandede grøntsager	1 -1,5 kg	 3; bageplade foret med bagepapir Brug dine yndlingskrydderier. Skær grøntsagerne i stykker.	30 min
P37	Kroketter, frosne	0,5 kg	 3; bageplade	25 min
P38	Pommes frites, frosne	0,75 kg	 3; bageplade	25 min
Gratiner, brød og pizza   				
P39	Lasagne/sammenkogte retter med nudler	1 -1,5 kg	 2; sammenkogt ret på grillrist	45 min
P40	Kartoffelgratin	1 -1,5 kg	 1; sammenkogt ret på grillrist	50 min
P41	Pizza frisk, tynd	-	  2;  100 ml; bageplade foret med bagepapir	15 min
P42	Pizza frisk, tyk	-	  2;  100 ml; bageplade foret med bagepapir	25 min
P43	Quiche	-	 2; bageform på grillrist	45 min
P44	Flute/ciabatta/hvidt brød	0,8 kg	  3;  150 ml; bageplade foret med bagepapir Mere tid til hvidt brød.	30 min
P45	Fuldkornsbrød/rugbrød i brødform	1 kg	  2;  150 ml; bageplade foret med bagepapir / grillrist	45 min







7. URFUNKTIONER







7.1 Urfunktioner











Urfunktioner	Applikation
	Minutur. Når den indstillede tid er gået, høres signalet.
	Tilberedningstid. Når den indstillede tid er gået, høres signalet, og ovnfunktionen stopper.
	Udskudt tid. For at udskyde starten og/eller tilberedningens afslutning.
	Optimer. Maksimum er 23 t 59 min. Denne funktion har ikke indflydelse på ovnen. For at tænde og slukke Optimer vælg: Menu, Indstillinger.

7.2 Sådan indstilles: Urfunktioner

Indstil: Aktuel tid		
Trin 1	Trin 2	Trin 3
		
For at ændre klokkeslættet skal du gå ind i menuen og vælge Indstillinger, Aktuel tid.	Indstil uret.	Tryk: OK.

Indstil: Minutur			
Trin 1	Displayet viser: 0:00 	Trin 2	Trin 3
			
Tryk på: 		Indstil Minutur	Tryk: OK.
 Timeren begynder straks at tælle ned.			

Indstil: Tilberedningstid					
Trin 1	Trin 2	Displayet viser: 0:00  STOP	Trin 3	Trin 4	
					
Vælg en ovnfunktion og indstil temperaturen.	Tryk gentagne gange:  .			Indstil tilberedningstiden.	Tryk: OK.
 Timeren begynder straks at tælle ned.					

Indstil: Udskudt tid									
Trin 1	Trin 2	Displayet viser: aktuel tid  START	Trin 3	Trin 4	Displayet viser: ---:  STOP	Trin 5	Trin 6		
									
Vælg ovnfunktion.	Tryk gentagne gange:  .			Indstil starttiden.		Tryk: OK.		Indstil sluttiden.	Tryk: OK.
 Timeren begynder at tælle ned ved en indstillet starttid.									

8. ANVENDELSE: TILBEHØR

8.1 Isætning af tilbehør

En lille fordybning i toppen øger sikkerheden. Fordybningerne er også antivippe-anordninger. Den høje kant omkring hylden forhindrer kogegrej i at glide af hylden.

ANVENDELSE: TILBEHØR

Grillrist:

Skub risten mellem ovnribbens skinner, .

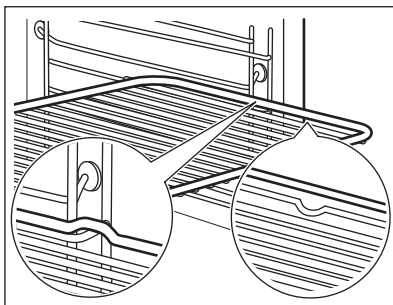

Bageplade /Dyb bradepande:

Skub pladen ind mellem skinnerne ud for den valgte rille.

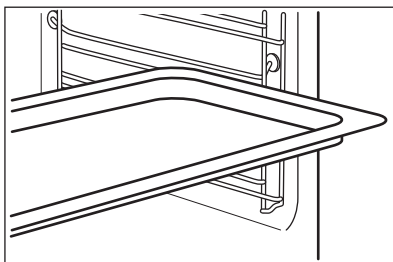

Grillrist, Bageplade /Dyb bradepande:

Skub pladen ind mellem ovnribbernes skinner og grillristen på skinnerne ovenover.

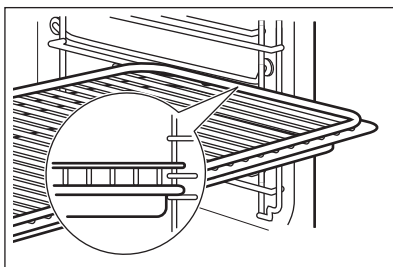

8.2 Termometer

Termometer- måler temperaturen i maden.

Der skal indstilles to temperaturer:



°C
Ovntemperaturen.

Kernetemperaturen.

For de bedste madlavningsresultater:

Ingredienserne bør være ved stuetemperatur.	Brug den ikke til flydende retter.	Under tilberedning skal det forblive i retten.
---	------------------------------------	--

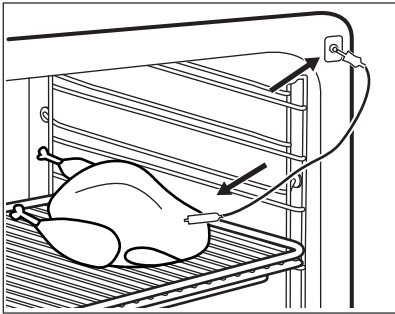
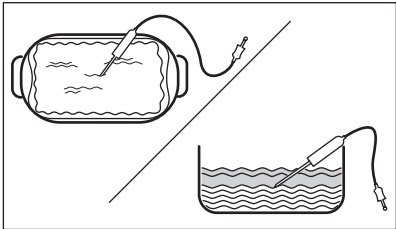
Anvendelse: Termometer







Trin 1	Tænd for ovnen.
Trin 2	Vælg en ovnfunktion og evt. ovntemperatur.
Trin 3	Indsæt: Termometer.
Kød, fjerkræ og fisk	Sammenkogte retter
Indsæt spidsen af Termometer i midten af kød, fisk, om muligt i den tykkeste del. Sørg for, at mindst 3/4 af Termometer er inde i retten.	Indsæt spidsen af Termometer nøjagtigt i midten af den sammenkogte ret. Termometer bør stabiliseres ét sted under bagning. Brug en fast ingrediens til at opnå dette. Brug kanten af bagepladen til at understøtte silikonehåndtaget på Termometer. Spidsen af Termometer bør ikke røre bunden af en bageform.
	
Trin 4	Stik Termometer i stikket på ovnens forside. Displayet viser den aktuelle temperatur af Termometer.
Trin 5	 - tryk for at indstille termometerets kernetemperatur.
Trin 6	OK - tryk for at bekræfte. Når maden når den indstillede temperatur, udsendes et signal. Du kan vælge at stoppe eller fortsætte tilberedningen for at sikre, at maden er gennemstegt.

EKSTRAFUNKTIONER

Trin 7	Tag Termometer-stikket ud af stikket, og tag retten ud af ovnen. <div style="border: 1px solid black; padding: 5px;"> ADVARSEL! Der er risiko for forbrændinger, da Termometer bliver varm. Pas på, når du trækker det ud og fjerner det fra maden.</div>
---------------	--



9. EKSTRAFUNKTIONER

9.1 Lås

Denne funktion forhindrer en utilsigtet ændring af ovnfunktionen.		
Tænd den, når ovnen virker - den indstillede tilberedning fortsætter, kontrolpanelet låses. Tænd den, når ovnen er slukket - ovnen kan ikke tændes, kontrolpanelet er låst.		
 	 OK - tryk og hold inde for at slå funktionen til. Der lyder et signal.	 OK - tryk og hold inde for at slukke.
 3 x  - blinker, når låsen er slået til.		

9.2 Automatisk slukning

Af sikkerhedsgrunde slukkes ovnen efter nogen tid, hvis en opvarmningsfunktion er i gang, og du ikke ændrer indstillingerne.

 (°C)	 (t)
30 - 115	12.5
120 - 195	8.5
200 - 245	5.5
250 - maksimum	3

Den automatiske slukning virker ikke med funktionerne: Lys, Termometer, Udskudt tid.

9.3 Køleventilator

Når ovnen er i brug, tændes blæseren automatisk for at holde ovnen kølig på de udvendige sider. Hvis du slukker for ovnen, kan køleblæseren fortsat være i brug, indtil ovnen afkøles.

9.4 Mekanisk lågelås

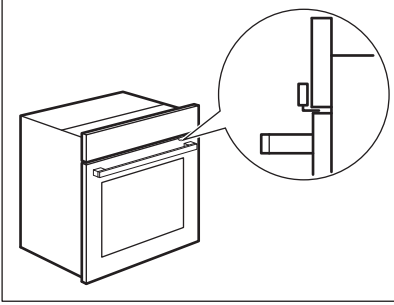
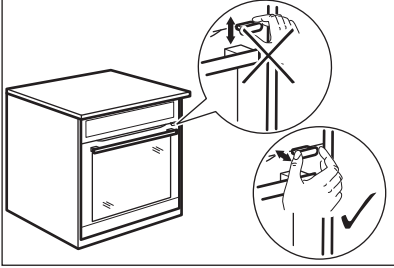
<p>Lågelåsen er ulåst, når du køber ovnen.</p>	
<p>⚠ FORSIGTIG! Bevæg ikke lågelåsen vertikalt. Tryk ikke på lågelåsen, når du lukker ovnlågen.</p>	

9.5 Anvendelse: Mekanisk lågelås

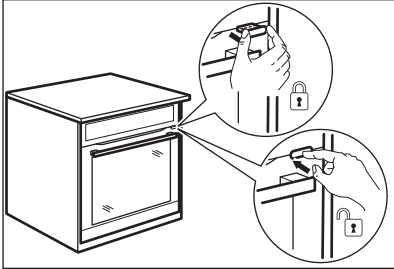
<p>Trin 1</p>	<p>Træk lågelåsen frem, indtil den låses, for at låse lågen.</p>
<p>Trin 2</p>	<p>For at låse op for lågen skal du trykke lågelåsen tilbage i panelet.</p> 

Åbning af den låste låge

Du kan åbne lågen, når den mekaniske lågelås er låst.

Trin 1

Tryk lågelåsen en smule, og åbn lågen ved at trække den med håndtaget.

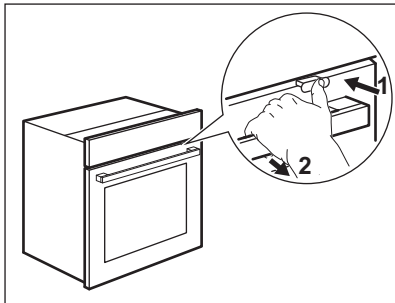



Når du lukker lågen, skal du sørge for, at lågelåsen forbliver låst.

10. RÅD OG TIPS





10.1 Fugtig varmluft

For at få de bedste resultater skal du følge forslagene angivet på nedenstående tabel. Brug ovnens tredje ristposition.

	 (°C)	 (min.)
Pastagratin	200 - 220	45 - 55
Kartoffelgratin	180 - 200	70 - 85
Moussaka	170 - 190	70 - 95
Lasagne	180 - 200	75 - 90
Cannelloni	180 - 200	70 - 85
Brødbudding	190 - 200	55 - 70
Risbudding	170 - 190	45 - 60
Æblekage, lavet af rørt kagedej (rund form)	160 - 170	70 - 80
Franskrød	190 - 200	55 - 70

10.2 Fugtig varmluft - anbefalet tilbehør







Brug mørke og ikke-reflekterende former og beholdere. De har en bedre varmeabsorbering end lyse og reflekterende fade.

			
Pizzaform	Bageform	Ramekiner	Tærtbundform
Mørk, ikke-reflekterende 28 cm diameter	Mørk, ikke-reflekterende 26 cm diameter	Keramisk 8 cm diameter, 5 cm højde	Mørk, ikke-reflekterende 28 cm diameter

10.3 Madlavningstabeller for testinstitutter

Oplysninger til testinstitutter

Tests i overensstemmelse med: EN 60350, IEC 60350.





 BAGNING PÅ ÉN RIBBE. Bagværk i form				
		 (°C)	 (min.)	
Fedtfattig sandkage	Varmluft	140 - 150	35 - 50	2
Fedtfattig sandkage	Over-/undervarme	160	35 - 50	2
Æbletærte, 2 forme Ø20 cm	Varmluft	160	60 - 90	2
Æbletærte, 2 forme Ø20 cm	Over-/undervarme	180	70 - 90	1



BAGNING PÅ ÉN RIBBE. Småkager







Brug ovnsens tredje ristposition.

		 (°C)	 (min.)
Smørkager / Kagesnitter	Varmluft	140	25 - 40
Smørkager / Kagesnitter, forvarm den tomme ovn	Over-/undervarme	160	20 - 30
Små kager i form, 20 stk./ plade, forvarm den tomme ovn	Varmluft	150	20 - 35
Små kager i form, 20 stk./ plade, forvarm den tomme ovn	Over-/undervarme	170	20 - 30



BAGNING PÅ FLERE RIBBER. Småkager





		 (°C)	 (min.)	
Smørkager / Kagesnitter	Varmluft	140	25 - 45	1 / 4
Små kager i form, 20 stk./ plade, forvarm den tomme ovn	Varmluft	150	23 - 40	1 / 4
Fedtfattig sandkage	Varmluft	160	35 - 50	1 / 4



Forvarm den tomme ovn i 5 minutter.



Grill med den maksimale temperaturindstilling.

		 (min.)	
Toast	Grillstegning	1 - 3	5
Oksesteak, vendes undervejs	Grillstegning	24 - 30	4



11. VEDLIGEHODELSE OG RENGØRING



ADVARSEL!

Se kapitlerne om sikkerhed.

11.1 Bemærkninger om rengøring

 Rengøringsmidler	Rengør ovns front med en blød klud opvredet i varmt vand tilsat et rengøringsmiddel.
	Brug en rengøringsopløsning for at rengøre metaloverflader.
	Rengør pletter med et mildt rengøringsmiddel. Anvend det ikke på de katalytiske overflader.
 Hverdagsbrug	Rengør altid ovnrummet efter brug. Ophobning af fedt eller andre rester kan medføre en brand.
	Opbevar ikke madvarer i ovnen i mere end 20 minutter. Tør ovnrummet med en blød klud efter hver brug.

	<p>Rengør alt tilbehør efter hver brug og lad det tørre. Brug en blød klud opvredet i varmt vand tilsat et mildt rengøringsmiddel. Tilbehøret må ikke vaskes i opvaskemaskinen.</p>
<p>Tilbehør</p>	<p>Rengør ikke slip let-tilbehøret med slibende rengøringsmiddel eller skarpe genstande.</p>

11.2 Rengøring: Prægning i ovnrum

Rengør fordybningen i ovnrumsmet for at fjerne kalkrester efter tilberedning med damp.

Trin 1	Trin 2	Trin 3
<p>Hæld: 250 ml hvid eddike ind i fordybningen i ovnrumsmet. Brug maks. 6 % eddike uden tilsætningsstoffer.</p>	<p>Lad eddiken opløse kalkresterne ved stuetemperatur i 30 minutter.</p>	<p>Rengør ovnrumsmet med varmt vand og en blød klud.</p>
<p>For funktionen: SteamBake rengør ovnen, hver gang der er gået 5 - 10 tilberedningscyklusser.</p>		

11.3 Fjernelse: Ovnribber

Fjern ovnribberne, så ovnen kan rengøres.

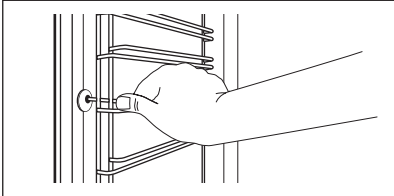
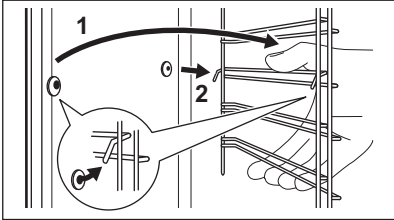

<p>Trin 1</p>	<p>Sluk for ovnen, og vent, til den er kold.</p>	
<p>Trin 2</p>	<p>Træk forenden af ribben væk fra sidevæggen.</p>	
<p>Trin 3</p>	<p>Træk den bageste ende af ovnribben væk fra sidevæggen, og fjern den.</p>	
<p>Trin 4</p>	<p>Montér ovnribberne i omvendt rækkefølge.</p>	

11.4 Anvendelse: Katalyserengøring

Ovnrummet er beklædt med katalytisk emalje. Den absorberer fedt under katalyse. Pletter eller misfarvning af den katalytiske belægning har ingen effekt på rengøringen.

Rengør ovnen med katalytisk rengøring

Fjern alt tilbehøret fra ovnen før katalyserengøring.

Trin 1	Trin 2	Trin 3
Vælg Menu  / Rengøring  / og tryk på OK.	Når rengøringen er slut, udsendes signalet. Ovnen slukkes.	Rengør ovnrummet med en våd, blød klud, når ovnen er kold.
Varighed: 1 t.		

11.5 Fjernelse og installation: Låge

Du kan tage lågen og det indvendige ovnglas ud for at rengøre det. Antallet af glaspaneler er forskelligt for forskellige modeller.



ADVARSEL!
Døren er tung.

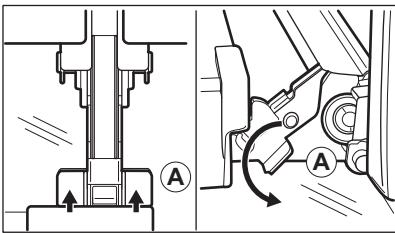

FORSIGTIG!
Håndter forsigtigt glasset, især omkring frontpanelets kanter. Glasset kan gå i stykker.

Trin 1	Åbn lågen helt.	
Trin 2	Løft og tryk låsegrebene (A) helt på de to lågehængsler.	
Trin 3	Sæt ovnlågen i den første tætte position (vinkel på ca. 70°). Hold lågen i begge sider, og træk den væk fra ovnen i en vinkel opad. Læg lågen med ydersiden nedad på en blød klud på et stabilt underlag.	

VEDLIGEHOJDELSE OG RENGØRING

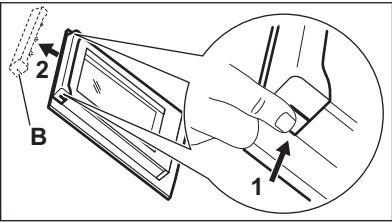
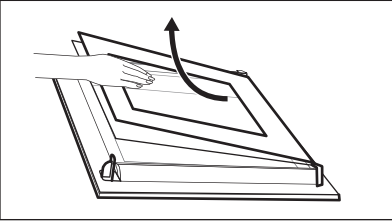
Trin 4	Hold i begge sider af lågelisten (B) i lågens overkant, og tryk indad, indtil låsehagen slipper.	
Trin 5	Træk lågelisten fremad, og tag den ud.	
Trin 6	Hold i overkanten af hvert enkelt ovnglas, og træk det opad og ud af skinnen.	
Trin 7	Rengør glaspanelet med vand og sæbe. Tør ovnglasset forsigtigt. Ovnglasset må ikke komme i opvaskemaskinen.	
Trin 8	Udfør ovennævnte trin i omvendt rækkefølge efter rengøring.	
Trin 9	Sæt det mindste glas i først og derefter det største og lågen. Sørg for, at glassene er sat i den rigtige position, da lågens overflade ellers kan blive overophedet.	

11.6 Udskiftning: Lampe



ADVARSEL!

Risiko for elektrisk stød
Pæren kan være varm.

Før du udskifter pæren:

Trin 1	Trin 2	Trin 3
Sluk for ovnen. Vent, til ovnen er kold.	Tag stikket ud af kontakten.	Læg en klud i bunden af ovnrummet.

Toplampe

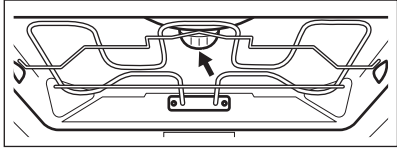
Trin 1	Drej glasset, og tag det af.	
Trin 2	Gør glasset rent.	
Trin 3	Udskift pæren med en passende 300 ° C varmebestandig pære.	
Trin 4	Montér dækglasset.	

Pære i siden

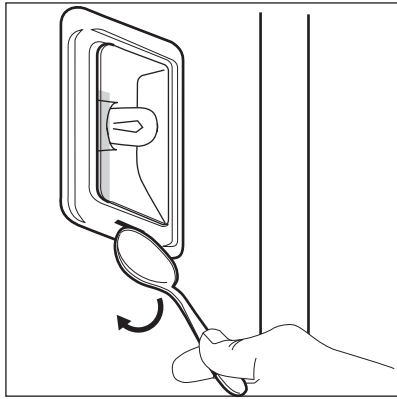
Trin 1	Fjern venstre ovnribbe for at få adgang til pæren.	
Trin 2	Lirk dækglasset af med en smal genstand uden spids (f.eks. en teske).	
Trin 3	Gør glasset rent.	
Trin 4	Udskift pæren med en passende 300 ° C varmebestandig pære.	
Trin 5	Montér dækglasset.	
Trin 6	Monter den venstre hyldeholder.	

12. FEJLFINDING



ADVARSEL!

Se kapitlerne om sikkerhed.

12.1 Hvad gør du, hvis ...

I eventuelle tilfælde, der ikke er inkluderet i denne tabel, bedes du kontakte et autoriseret servicecenter.



Ovnen tændes ikke eller bliver ikke opvarmet

Problem	Kontrollér, om ...
Ovnen kan ikke tændes eller betjenes.	Ovnen er korrekt tilsluttet til en strømforsyning.
Ovnen opvarmes ikke.	Den automatiske slukning er deaktiveret.
Ovnen opvarmes ikke.	Sikringen er ikke sprunget.
Ovnen opvarmes ikke.	Børnesikringen er ikke aktiveret.



Komponenter

Problem	Kontrollér, om ...
Lyset er slukket.	Fugtig varmluft - er tændt.
Pæren virker ikke.	Pæren er sprunget.
Termometer virker ikke.	Stikket fra Termometer er sat helt ind i stikkontakten.



Fejlkode

Displayet viser...	Kontrollér, om ...
Err C2	Du tog Termometer stikket ud af stikkontakten.
00:00	Der har været strømafbrydelse. Indstil aktuel tid.

Hvis displayet viser en fejlkode, der ikke findes i denne tabel, skal husets sikring slukkes og tændes for at genstarte ovnen. Kontakt et autoriseret servicecenter, hvis fejlkoden forekommer igen.



Rengøring

Problem	Kontrollér, om ...
---------	--------------------

**Rengøring**

Vandet kommer ud af fordybningen i ovnrummet.

Der er for meget vand i fordybningen i ovnrummet.

12.2 Serviceoplysninger

Kontakt forhandleren eller et autoriseret servicecenter, hvis du ikke selv kan løse problemet. De nødvendige oplysninger til servicecenteret er angivet på typeskiltet. Typeskiltet er placeret på ovnrummets frontramme. Typeskiltet må ikke fjernes fra ovnrummet.

Det anbefales, at du noterer oplysningerne her:

Model (MOD.)

.....

Produktnummer (PNC)

.....

Serienummer (S.N.)

.....

13. ENERGIEFFEKTIV

13.1 Produktinformation og produktinformationsark*

Leverandørens navn	Electrolux
Identifikation af model	COC826X 944032024
Energieffektivitetsindeks	81.2
Energieffektivitetsklasse	A+
Energiforbrug med en standardmængde, almindelig tilstand	1.09 kWh/cyklus
Energiforbrug med en standardmængde, blæsertvungen tilstand	0.69 kWh/cyklus
Antal ovnrum	1
Varmekilde	Elektricitet
Volumen	71 l

Type ovn	Indbygningsovn
Vægt	33.0 kg

* For EU ifølge EU-forordninger 65/2014 og 66/2014.
For Hviderusland ifølge STB 2478-2017, bilag G; STB 2477-2017, bilag A og B.
For Ukraine ifølge 568/32020.

Energieffektivitetsklasse gælder ikke for Rusland.

EN 60350-1 - Elkogeapparater til husholdning - Del 1: Komfurer, ovne, dampovne og grillapparater - Metoder til måling af ydeevne.

13.2 Energibesparelse



Ovnen indeholder funktioner, som hjælper dig med at spare energi ved daglig madlavning.

Sørg for, at ovnlågen er lukket, når ovnen bruges. Åbn ikke lågen for ofte under tilberedningen.

Hold dørpakningen ren og sørg for, at den sidder godt fast.

Brug køkkengrej af metal for at øge energibesparelsen.

Forvarm om muligt ikke ovnen inden tilberedning.

Hold pauserne mellem bagning så korte som muligt, når du tilbereder nogle få retter på én gang.

Tilberedning med blæser

Brug om muligt tilberedningsfunktionerne med blæser for at spare energi.

Restvarme

Blæseren og lampen bliver ved med at være tændt. Når du tænder for ovnen viser displayet eftervarmen. Du kan bruge varmen til at holde maden varm.

Når tilberedningsvarigheden er længere end 30 min., skal du reducere ovntemperaturen til minimum 3 - 10 min. inden afslutningen af tilberedningen. Restvarmen i ovnen bliver ved med at tilberede maden.

Brug restvarmen til at opvarme andre retter.

Hold maden varm

Vælg den lavest mulige temperaturindstilling for at bruge restvarme og holde et måltid varmt.

Restvarmelampen eller temperaturen vises på displayet.

Tilberedning med slukket lampe

Sluk for lampen under tilberedning. Tænd kun for det, når det er nødvendigt.



Fugtig varmluft



Denne funktion er beregnet til at spare energi under madlavning.



Når du bruger denne funktion, slukkes lampen automatisk efter 30 sekunder. Du kan tænde det igen, men denne handling vil mindske den forventede energibesparelse.

14. MENUSTRUKTUR

14.1 Menu

	 - vælg for at åbne Menu.
---	--



Menu struktur		
Hjælp til tilberedning 	Rengøring 	Indstillinger 

Trin 1	Trin 2	Trin 3	Trin 4	Trin 5
 	 OK	 O1 - O14	 OK	
Vælg Menu, Indstillinger.	Bekræft indstillingen.	Vælg indstillingen.	Bekræft indstillingen.	Justér værdien, og tryk på OK.

Indstillinger					
O1	Aktuel tid	Skift	O2	Lysstyrke display	1 - 5
O3	Panelsignal	1 - Bip 2 - Klik 3 - Lyd fra	O4	Signal volume	1 - 4
O5	Termometer Handling	1 - Alarm og stop 2 - Alarm	O6	Optimer	Tænd / sluk
O7	Lys	Tænd / sluk	O8	Hurtig opvarmning	Tænd / sluk
O9	Wi-Fi	Tænd / sluk	O10	Automatisk fjernbetjening	Tænd / sluk
O11	Glem netværk	Ja/nej	O12	Demo funktion	Aktiveringskode: 2468

Indstillinger					
O13	Softwareversion	Kontroller	O14	Nulstil alle indstillinger	Ja/nej

15. MILJØHENSYN

Genbrug materialer med symbolet . Anbring emballagematerialet i passende beholdere til genbrug. Hjælp med at beskytte miljøet og menneskelig sundhed samt at genbruge affald af elektriske og elektroniske apparater. Kasser ikke apparater, der er mærket med symbolet , sammen med husholdningsaffaldet. Lever produktet tilbage til din lokale genbrugsplads eller kontakt din kommune.

WE'RE THINKING OF YOU

Thank you for purchasing an Electrolux appliance. You've chosen a product that brings with it decades of professional experience and innovation. Ingenious and stylish, it has been designed with you in mind. So whenever you use it, you can be safe in the knowledge that you'll get great results every time.

Welcome to Electrolux.

Visit our website to:



Get usage advice, brochures, trouble shooter, service and repair information:
www.electrolux.com/support



Register your product for better service:
www.registerelectrolux.com



Buy Accessories, Consumables and Original spare parts for your appliance:
www.electrolux.com/shop



For more recipes, hints, troubleshooting download **My Electrolux Kitchen** app.



CUSTOMER CARE AND SERVICE

Always use original spare parts.

When contacting our Authorised Service Centre, ensure that you have the following data available: Model, PNC, Serial Number.

The information can be found on the rating plate.

 Warning / Caution-Safety information

 General information and tips

 Environmental information

Subject to change without notice.

CONTENTS

1. SAFETY INFORMATION.....	43	2.7 Disposal.....	47
1.1 Children and vulnerable people safety.....	43	3. PRODUCT DESCRIPTION.....	47
1.2 General Safety.....	43	3.1 General overview.....	48
2. SAFETY INSTRUCTIONS.....	44	3.2 Accessories.....	48
2.1 Installation.....	44	4. HOW TO TURN OVEN ON AND OFF.....	49
2.2 Electrical connection.....	45	4.1 Retractable knobs.....	49
2.3 Use.....	46	4.2 Control panel.....	49
2.4 Care and cleaning.....	47	5. BEFORE FIRST USE.....	51
2.5 Internal lighting.....	47	5.1 Initial cleaning.....	51
2.6 Service.....	47	5.2 Initial preheating.....	51

CONTENTS

5.3 Wireless connection 	51	10.2 Moist Fan Baking - recommended accessories.....	68
5.4 Software licences.....	52	10.3 Cooking tables for test institutes..	68
6. DAILY USE.....	52	11. CARE AND CLEANING.....	70
6.1 How to set: Heating functions.....	53	11.1 Notes on cleaning.....	71
6.2 Heating functions.....	53	11.2 How to clean: Cavity embossment.....	71
6.3 Notes on: Moist Fan Baking.....	55	11.3 How to remove: Shelf supports ...	71
6.4 How to set: Assisted Cooking.....	55	11.4 How to use: Catalytic cleaning ...	72
6.5 Assisted Cooking with recipes.....	56	11.5 How to remove and install: Door..	72
7. CLOCK FUNCTIONS.....	61	11.6 How to replace: Lamp.....	73
7.1 Clock functions.....	61	12. TROUBLESHOOTING.....	74
7.2 How to set: Clock functions.....	61	12.1 What to do if.....	75
8. HOW TO USE: ACCESSORIES.....	62	12.2 Service data.....	76
8.1 Inserting accessories.....	63	13. ENERGY EFFICIENCY.....	76
8.2 Food Sensor.....	63	13.1 Product Information and Product Information Sheet*.....	76
9. ADDITIONAL FUNCTIONS.....	65	13.2 Energy saving.....	77
9.1 Lock.....	65	14. MENU STRUCTURE.....	77
9.2 Automatic switch-off.....	65	14.1 Menu.....	78
9.3 Cooling fan.....	66		
9.4 Mechanical door lock.....	66		
9.5 How to use: Mechanical door lock.....	66		
10. HINTS AND TIPS.....	67		
10.1 Moist Fan Baking.....	67		

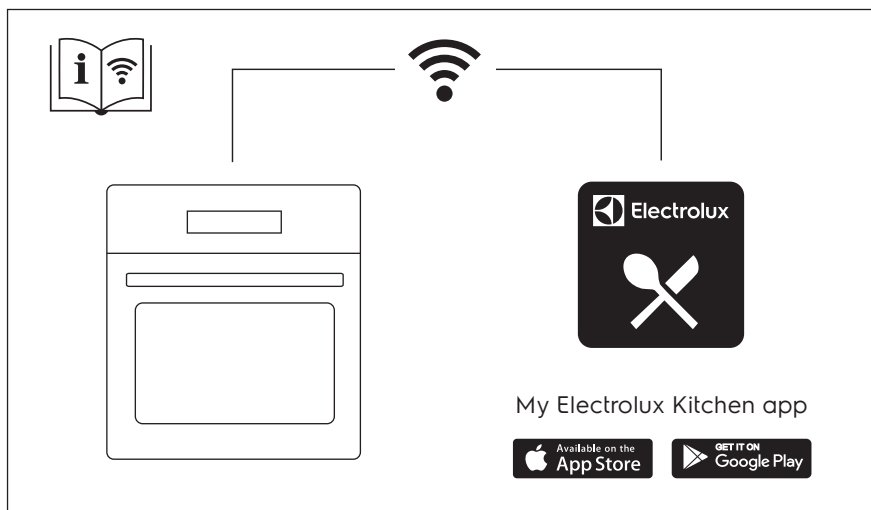

1. ⚠ SAFETY INFORMATION

Before the installation and use of the appliance, carefully read the supplied instructions. The manufacturer is not responsible for any injuries or damage that are the result of incorrect installation or usage. Always keep the instructions in a safe and accessible location for future reference.

1.1 Children and vulnerable people safety

- This appliance can be used by children aged from 8 years and above and persons with reduced physical, sensory or mental capabilities or lack of experience and knowledge if they have been given supervision or instruction concerning the use of the appliance in a safe way and understand the hazards involved. Children of less than 8 years of age and persons with very extensive and complex disabilities shall be kept away from the appliance unless continuously supervised.
- Children should be supervised to ensure that they do not play with the appliance and mobile devices with My Electrolux Kitchen.
- Keep all packaging away from children and dispose of it appropriately.
- **WARNING:** Keep children and pets away from the appliance when it operates or when it cools down. Accessible parts become hot during use.
- If the appliance has a child safety device, it should be activated.
- Children shall not carry out cleaning and user maintenance of the appliance without supervision.

1.2 General Safety

- Only a qualified person must install this appliance and replace the cable.

SAFETY INSTRUCTIONS

- Do not use the appliance before installing it in the built-in structure.
- Disconnect the appliance from the power supply before carrying out any maintenance.
- If the mains power supply cable is damaged, it must be replaced by the manufacturer, its Authorised Service Centre or similarly qualified persons to avoid an electrical hazard.
- **WARNING:** Ensure that the appliance is switched off before replacing the lamp to avoid the possibility of electric shock.
- **WARNING:** The appliance and its accessible parts become hot during use. Care should be taken to avoid touching heating elements.
- Always use oven gloves to remove or put in accessories or ovenware.
- Use only the food sensor (core temperature sensor) recommended for this appliance.
- To remove the shelf supports first pull the front of the shelf support and then the rear end away from the side walls. Install the shelf supports in the opposite sequence.
- Do not use a steam cleaner to clean the appliance.
- Do not use harsh abrasive cleaners or sharp metal scrapers to clean the glass door since they can scratch the surface, which may result in shattering of the glass.

2. SAFETY INSTRUCTIONS

2.1 Installation

**WARNING!**

Only a qualified person must install this appliance.

- Remove all the packaging.
- Do not install or use a damaged appliance.
- Follow the installation instructions supplied with the appliance.
- Always take care when moving the appliance as it is heavy. Always use safety gloves and enclosed footwear.
- Do not pull the appliance by the handle.
- Install the appliance in a safe and suitable place that meets installation requirements.
- Keep the minimum distance from other appliances and units.
- Before mounting the appliance, check if the oven door opens without restraint.

SAFETY INSTRUCTIONS

- The appliance is equipped with an electric cooling system. It must be operated with the electric power supply.
- The built-in unit must meet the stability requirements of DIN 68930.

Cabinet minimum height (Cabinet under the work-top minimum height)	578 (600) mm
Cabinet width	560 mm
Cabinet depth	550 (550) mm
Height of the front of the appliance	594 mm
Height of the back of the appliance	576 mm
Width of the front of the appliance	595 mm
Width of the back of the appliance	559 mm
Depth of the appliance	567 mm
Built in depth of the appliance	546 mm
Depth with open door	1027 mm
Ventilation opening minimum size. Opening placed on the bottom rear side	560 x 20 mm
Mains supply cable length. Cable is placed in the right corner of the back side	1500 mm
Mounting screws	4 x 25 mm

2.2 Electrical connection



WARNING!

Risk of fire and electric shock.

- All electrical connections should be made by a qualified electrician.
- The appliance must be earthed.
- Make sure that the parameters on the rating plate are compatible with the electrical ratings of the mains power supply.
- Always use a correctly installed shockproof socket.
- Do not use multi-plug adapters and extension cables.
- Make sure not to cause damage to the mains plug and to the mains cable. Should the mains cable need to be replaced, this must be carried out by our Authorised Service Centre.
- Do not let mains cables touch or come near the appliance door or the niche below the appliance, especially when it operates or the door is hot.

SAFETY INSTRUCTIONS

- The shock protection of live and insulated parts must be fastened in such a way that it cannot be removed without tools.
- Connect the mains plug to the mains socket only at the end of the installation. Make sure that there is access to the mains plug after the installation.
- If the mains socket is loose, do not connect the mains plug.
- Do not pull the mains cable to disconnect the appliance. Always pull the mains plug.
- Use only correct isolation devices: line protecting cut-outs, fuses (screw type fuses removed from the holder), earth leakage trips and contactors.
- The electrical installation must have an isolation device which lets you disconnect the appliance from the mains at all poles. The isolation device must have a contact opening width of minimum 3 mm.
- This appliance is supplied with a main plug and a main cable.

2.3 Use



WARNING!

Risk of injury, burns and electric shock or explosion.

- This appliance is for household (indoors) use only.
- Do not change the specification of this appliance.
- Make sure that the ventilation openings are not blocked.
- Do not let the appliance stay unattended during operation.
- Deactivate the appliance after each use.
- Be careful when you open the appliance door while the appliance is in operation. Hot air can release.
- Do not operate the appliance with wet hands or when it has contact with water.
- Do not apply pressure on the open door.
- Do not use the appliance as a work surface or as a storage surface.
- Open the appliance door carefully. The use of ingredients with alcohol can cause a mixture of alcohol and air.
- Do not let sparks or open flames to come in contact with the appliance when you open the door.
- Do not put flammable products or items that are wet with flammable products in, near or on the appliance.
- Do not share your Wi-Fi password.



WARNING!

Risk of damage to the appliance.

- To prevent damage or discoloration to the enamel:
 - do not put overware or other objects in the appliance directly on the bottom.
 - do not put aluminium foil directly on the bottom of cavity of the appliance.
 - do not put water directly into the hot appliance.
 - do not keep moist dishes and food in the appliance after you finish the cooking.
 - be careful when you remove or install the accessories.
- Discoloration of the enamel or stainless steel has no effect on the performance of the appliance.
- Use a deep pan for moist cakes. Fruit juices cause stains that can be permanent.
- This appliance is for cooking purposes only. It must not be used for other purposes, for example room heating.

- Always cook with the oven door closed.
- If the appliance is installed behind a furniture panel (e.g. a door) make sure the door is never closed when the appliance operates. Heat and moisture can build up behind a closed furniture panel and cause subsequent damage to the appliance, the housing unit or the floor. Do not close the furniture panel until the appliance has cooled down completely after use.

2.4 Care and cleaning



WARNING!

Risk of injury, fire, or damage to the appliance.

- Before maintenance, deactivate the appliance and disconnect the mains plug from the mains socket.
- Make sure the appliance is cold. There is the risk that the glass panels can break.
- Replace immediately the door glass panels when they are damaged. Contact the Authorised Service Centre.
- Be careful when you remove the door from the appliance. The door is heavy!
- Clean regularly the appliance to prevent the deterioration of the surface material.
- Clean the appliance with a moist soft cloth. Use only neutral detergents. Do not use abrasive products, abrasive cleaning pads, solvents or metal objects.
- If you use an oven spray, follow the safety instructions on its packaging.
- Do not clean the catalytic enamel with detergents.

2.5 Internal lighting



WARNING!

Risk of electric shock.

- Concerning the lamp(s) inside this product and spare part lamps sold separately: These lamps are intended to withstand extreme physical conditions in household appliances, such as temperature, vibration, humidity, or are intended to signal information about the operational status of the appliance. They are not intended to be used in other applications and are not suitable for household room illumination.
- Use only lamps with the same specifications.

2.6 Service

- To repair the appliance contact the Authorised Service Centre.
- Use original spare parts only.

2.7 Disposal



WARNING!

Risk of injury or suffocation.

- Disconnect the appliance from the mains supply.
- Cut off the mains electrical cable close to the appliance and dispose of it.
- Remove the door catch to prevent children or pets from becoming trapped in the appliance.

3. PRODUCT DESCRIPTION

3.1 General overview

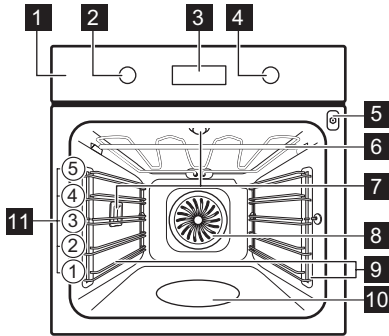

- 1** Control panel
- 2** Knob for the heating functions
- 3** Display
- 4** Control knob
- 5** Socket for the food sensor
- 6** Heating element
- 7** Lamp
- 8** Fan
- 9** Shelf support, removable
- 10** Cavity embossment
- 11** Shelf positions

3.2 Accessories

Wire shelf

For cookware, cake tins, roasts.

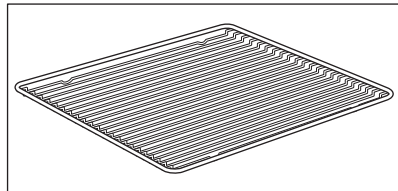

HOW TO TURN OVEN ON AND OFF

Baking tray

For cakes and biscuits.

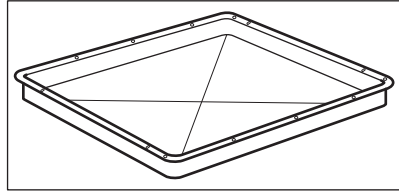

Grill- / Roasting pan

To bake and roast or as a pan to collect fat.

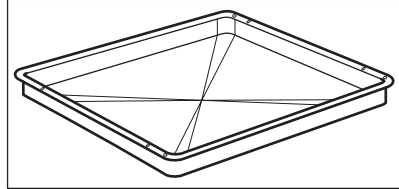

Patisserie tray

For rolls, pretzels and small pastries. Suitable for steam functions. The discolouration of the surface has no effect on the functions.

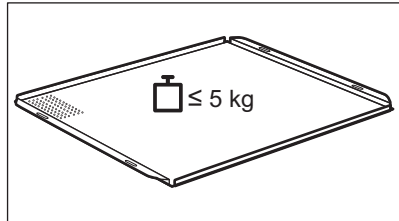

Food sensor

To measure the temperature inside food.

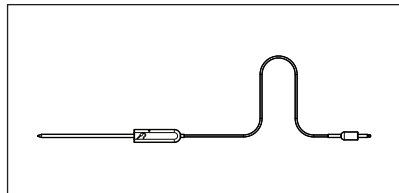







4. HOW TO TURN OVEN ON AND OFF

4.1 Retractable knobs

To use the appliance press the knob. The knob comes out.









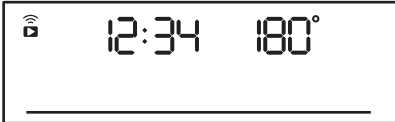
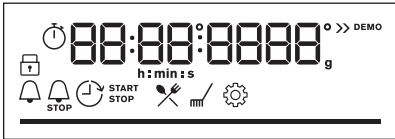

4.2 Control panel

Control panel sensor fields					Press	Turn the knob
 Timer	 Fast Heat Up	 Light	 Food Sensor	OK		



HOW TO TURN OVEN ON AND OFF

Control panel sensor fields	Press	Turn the knob
Select a heating function to turn on the oven.		
Turn the knob for the heating functions to the off position to turn the oven off.		

	When the knob for the heating functions is in the off position, the display goes to standby.
	When you cook, the display shows the set temperature, time of day and other available options.
	The display with the maximum number of functions set.

Display indicators				
 Lock	 Assisted Cooking	 Cleaning	 Settings	 Fast Heat Up
Timer indicators:				
Wi-Fi indicator - flashes when the oven can be connected to Wi-Fi.			Remote operation indicator - the oven can be controlled remotely.	
 Wi-Fi connection is turned on.			 Remote operation is turned on.	

Progress bar - for temperature or time.	
--	---

Steam cooking indicator	
Food sensor indicator	





5. BEFORE FIRST USE







WARNING!

Refer to Safety chapters.

5.1 Initial cleaning

Before the first use clean the empty oven and set the time:			
			 00:00 Set the time. Press OK .

5.2 Initial preheating

	Preheat the empty oven before the first use.		
Step 1	Remove all accessories and removable shelf supports from the oven.		
Step 2	Set the maximum temperature for the function:  Let the oven operate for 1 h.		
Step 3	Set the maximum temperature for the function:  Let the oven operate for 15 min.		
 The oven can emit an odour and smoke during preheating. Make sure that the room is ventilated.			

5.3 Wireless connection

To connect the oven you need:

- Wireless network with the Internet connection.
- Mobile device connected to your wireless network.

DAILY USE

Step 1	Download the mobile app My Electrolux Kitchen and follow the instructions for the next steps.
Step 2	Turn the knob to select:  .

Frequency	2.4 GHz WLAN	5 GHz WLAN
	2400 - 2483.5 MHz	5150 - 5350 MHz 5470 - 5725 MHz
Protocol	IEEE 802.11b DSSS, 802.11g/n OFDM	IEEE 802.11 a/n OFDM
Max Power	EIRP < 20 dBm (100 mW)	EIRP < 23 dBm (200 mW)
Wi-Fi module	NIU5-50	

Frequency Bluetooth	2400 - 2483.5 MHz
Protocol	LE: DSSS
Max Power	EIRP < 4 dBm (2.5 mW)

EU member states covered by the provision of Directive 2014/53/EU: Belgium, Bulgaria, Czech Republic, Denmark, Germany, Estonia, Ireland, Greece, Spain, France, Croatia, Italy, Cyprus, Latvia, Lithuania, Luxemburg, Hungary, Malta, Netherlands, Austria, Poland, Portugal, Romania, Slovenia, Slovakia, Finland, Sweden, Norway, Switzerland, United Kingdom, Turkey.



5.4 Software licences



The software in this product contains components that are based on free and open source software. Electrolux gratefully acknowledges the contributions of the open software and robotics communities to the development project.
To access the source code of these free and open source software components whose license conditions require publishing, and to see their full copyright information and applicable license terms, please visit: http://electrolux.opensoftwarerepository.com (folder NIU5).

6. DAILY USE

 WARNING! Refer to Safety chapters.

6.1 How to set: Heating functions









Start cooking	
Step 1	Step 2
	
Set a heating function.	Set the temperature.

Steam cooking			
Make sure that the oven is cold.			
Step 1	Step 2	Step 3	Step 4
			Preheat the empty oven for 10 min to create humidity. Put food in the oven.
Fill the cavity embossment with tap water.	Set the steam heating function.	Set the temperature.	
ⓘ The maximum capacity of the cavity embossment is 250 ml. Do not refill the cavity embossment during cooking or when the oven is hot.			

When the steam cooking ends:		
Step 1	Step 2	Step 3
Turn the knob for the heating functions to the off position to turn off the oven.	Carefully open the door. Released humidity can cause burns.	Make sure that the oven is cold. Remove the remaining water from the cavity embossment.

6.2 Heating functions

Standard heating functions

Heating function	Application
 <p>True Fan Cooking</p>	To bake on up to three shelf positions at the same time and to dry food. Set the temperature 20 - 40 °C lower than for Conventional Cooking.
 <p>Conventional Cooking</p>	To bake and roast food on one shelf position.
 <p>SteamBake</p>	To add humidity during the cooking. To get the right colour and crispy crust during baking. To give more juiciness during reheating. To preserve fruit or vegetables.
 <p>Pizza Function</p>	To bake pizza. To make intensive browning and a crispy bottom.
 <p>Bottom Heat</p>	To bake cakes with crispy bottom and to preserve food.
 <p>Frozen Foods</p>	To make convenience food (e.g., french fries, potato wedges or spring rolls) crispy.
 <p>Moist Fan Baking</p>	This function is designed to save energy during cooking. When you use this function, the temperature in the cavity may differ from the set temperature. The residual heat is used. The heating power may be reduced. For more information refer to "Daily Use" chapter, Notes on: Moist Fan Baking.
 <p>Grill</p>	To grill thin pieces of food and to toast bread.
 <p>Turbo Grilling</p>	To roast large meat joints or poultry with bones on one shelf position. To make gratins and to brown.

Heating function	Application
 Menu	To enter the Menu: Assisted Cooking, Cleaning, Settings.

6.3 Notes on: Moist Fan Baking

This function was used to comply with the energy efficiency class and ecodesign requirements according to EU 65/2014 and EU 66/2014. Tests according to EN 60350-1.

The oven door should be closed during cooking so that the function is not interrupted and the oven operates with the highest energy efficiency possible.







When you use this function the lamp automatically turns off after 30 sec.

For the cooking instructions refer to "Hints and tips" chapter, Moist Fan Baking. For general energy saving recommendations refer to "Energy Efficiency" chapter, Energy Saving.





6.4 How to set: Assisted Cooking

Every dish in this submenu has a recommended function and temperature. You can adjust the time and the temperature during cooking.









For some of the dishes you can also cook with:	The degree to which a dish is cooked:
<ul style="list-style-type: none"> • Food Sensor 	<ul style="list-style-type: none"> • Rare • Medium • Well done









Assisted Cooking - use it to prepare a dish quickly with default settings:			
Step 1	Step 2	Step 3	Step 4
 	 	 1 - 45	 OK
Enter the menu.	Select Assisted Cooking. Press OK.	Select the dish. Press OK.	Insert the dish to the oven. Confirm setting.



















6.5 Assisted Cooking with recipes



























Legend	
	Food sensor available. Place the Food sensor in the thickest part of the dish. The oven turns off when the set Food sensor temperature is reached.
	The amount of water for the steam function.
	Preheat the oven before you start cooking.
	Shelf level.

















When the function ends check if the food is ready.



	Dish	Weight	Shelf level / Accessory	Duration time
Beef 				
P1	Roast Beef, rare	1 - 1,5 kg; 4 - 5 cm thick pieces	  2; baking tray Fry the meat for a few minutes on a hot pan. Insert to the oven.	~ 40 min
P2	Roast Beef, medium			~ 50 min
P3	Roast Beef, well done			~ 60 min
P4	Steak, medium	180 - 220 g per piece; 3 cm thick slices	   3; roasting dish on wire shelf Fry the meat for a few minutes on a hot pan. Insert to the oven.	~ 15 min
P5	Beef roast / braised (prime rib, top round, thick flank)	1,5 - 2 kg	  2; roasting dish on wire shelf Fry the meat for a few minutes on a hot pan. Add liquid. Insert to the oven.	~ 120 min

	Dish	Weight	Shelf level / Accessory	Duration time
P6	Roast Beef, rare (slow cooking)	1 - 1,5 kg; 4 - 5 cm thick pieces	 2; baking tray Use your favourite spices or simply salt and fresh grounded pepper. Fry the meat for a few minutes on a hot pan. Insert to the oven.	~ 75 min
P7	Roast Beef, medium (slow cooking)			~ 85 min
P8	Roast Beef, well done (slow cooking)			~ 130 min
P9	Fillet, rare (slow cooking)	0,5 - 1,5 kg; 5 - 6 cm thick pieces	 2; baking tray Use your favourite spices or simply salt and fresh grounded pepper. Fry the meat for a few minutes on a hot pan. Insert to the oven.	~ 75 min
P10	Fillet, medium (slow cooking)			~ 90 min
P11	Fillet, done (slow cooking)			~ 120 min
Veal 				
P12	Veal roast (e.g. shoulder)	0,8 - 1,5 kg; 4 cm thick pieces	 2; roasting dish on wire shelf Use your favourite spices. Add liquid. Roast covered.	~ 80 min
Pork  				
P13	Pork roast neck or shoulder	1,5 - 2 kg	 2; roasting dish on wire shelf Turn the meat after half of the cooking time.	~ 120 min
P14	Pulled pork LTC	1,5 - 2 kg	 2; baking tray Use your favourite spices. Turn the meat after half of the cooking time to get an even browning.	~ 215 min
P15	Loin, fresh	1 - 1,5 kg; 5 - 6 cm thick pieces	 2; roasting dish on wire shelf Use your favourite spices.	~ 55 min

	Dish	Weight	Shelf level / Accessory	Duration time
P16	Spare Ribs	2 - 3 kg; use raw, 2 - 3 cm thin spare ribs	 3; deep pan Add liquid to cover the bottom of a dish. Turn the meat after half of the cooking time.	90 min
Lamb 				
P17	Lamb leg with bones	1,5 - 2 kg; 7 - 9 cm thick pieces	  2; roasting dish on baking tray Add liquid. Turn the meat after half of the cooking time.	~ 130 min
Poultry 				
P18	Whole chicken	1 - 1,5 kg; fresh	  2; 200 ml; casserole dish on baking tray Use your favourite spices. Turn the chicken after half of the cooking time to get an even browning.	~ 60 min
P19	Half chicken	0,5 - 0,8 kg	  3; baking tray Use your favourite spices.	~ 40 min
P20	Chicken breast	180 - 200 g per piece	   2; casserole dish on wire shelf Use your favourite spices. Fry the meat for a few minutes on a hot pan.	~ 25 min
P21	Chicken legs, fresh	-	  3; baking tray If you marinated chicken legs first, set lower temperature and cook them longer.	~ 30 min
P22	Duck, whole	2 - 3 kg	  2; roasting dish on wire shelf Use your favourite spices. Put the meat on roasting dish. Turn the duck after half of the cooking time.	~ 100 min
P23	Goose, whole	4 - 5 kg	  2; deep pan Use your favourite spices. Put the meat on deep baking tray. Turn the goose after half of the cooking time.	~ 110 min





	Dish	Weight	Shelf level / Accessory	Duration time
Other 				
P24	Meat loaf	1 kg	  2; wire shelf Use your favourite spices.	~ 60 min
Fish 				
P25	Whole fish, grilled	0,5 - 1 kg per fish	  2; baking tray Fill the fish with butter and use your favourite spices and herbs.	~ 30 min
P26	Fish fillet	-	  3; casserole dish on wire shelf Use your favourite spices.	20 min
Sweet baking / desserts   				
P27	Cheesecake	-	 2;  28 cm springform tin on wire shelf	90 min
P28	Apple cake	-	 2;  100 - 150 ml; baking tray	60 min
P29	Apple tart	-	 2; pie form on wire shelf	40 min
P30	Apple pie	-	 2;  100 - 150 ml;  22 cm pie form on wire shelf	60 min
P31	Brownies	2 kg	 3; deep pan	30 min
P32	Chocolate muffins	-	 2;  100 - 150 ml; muffin tray on wire shelf	30 min
P33	Loaf cake	-	 2; loaf pan on wire shelf	50 min
Vegetable / Side dishes   				

	Dish	Weight	Shelf level / Accessory	Duration time
P34	Baked potatoes	1 kg	 2; baking tray Put the whole potatoes with skin on baking tray.	50 min
P35	Wedges	1 kg	 3; baking tray lined with baking paper Use your favourite spices. Cut potatoes into pieces.	35 min
P36	Grilled mixed vegetables	1 - 1,5 kg	 3; baking tray lined with baking paper Use your favourite spices. Cut the vegetables into pieces.	30 min
P37	Croquets, frozen	0,5 kg	 3; baking tray	25 min
P38	Pommes, frozen	0,75 kg	 3; baking tray	25 min
Gratins, bread and pizza   				
P39	Lasagna / Noodle casserole	1 - 1,5 kg	 2; casserole dish on wire shelf	45 min
P40	Potato gratin	1 - 1,5 kg	 1; casserole dish on wire shelf	50 min
P41	Pizza fresh, thin	-	  2; 100 ml; baking tray lined with baking paper	15 min
P42	Pizza fresh, thick	-	  2; 100 ml; baking tray lined with baking paper	25 min
P43	Quiche	-	 2; baking tin on wire shelf	45 min
P44	Baguette / Ciabatta / White bread	0,8 kg	  3; 150 ml; baking tray lined with baking paper More time needed for white bread.	30 min



	Dish	Weight	Shelf level / Accessory	Duration time
P45	All grain / rye / dark bread all grain in loaf pan	1 kg	  2;  150 ml; baking tray lined with baking paper / wire shelf	45 min

7. CLOCK FUNCTIONS







7.1 Clock functions









Clock Function	Application
	Minute minder. When the timer ends, the signal sounds.
	Cooking time. When the timer ends, the signal sounds and the heating function stops.
	Time Delay. To postpone the start and / or end of cooking.
	Uptimer. Maximum is 23 h 59 min. This function has no effect on the operation of the oven. To turn on and off the Uptimer select: Menu, Settings.













7.2 How to set: Clock functions

How to set: Time of day		
Step 1	Step 2	Step 3
		
To change the time of day enter the menu and select Settings, Time of day.	Set the clock.	Press: OK.

HOW TO USE: ACCESSORIES

How to set: Minute minder			
Step 1	The display shows: 0:00 	Step 2	Step 3
			
Press: 		Set the Minute minder	Press: OK , 
 Timer starts counting down immediately.			

How to set: Cooking time				
Step 1	Step 2	The display shows: 0:00  STOP	Step 3	Step 4
				
Choose a heating function and set the temperature.	Press repeatedly: 		Set the cooking time.	Press: OK , 
 Timer starts counting down immediately.				

How to set: Time Delay							
Step 1	Step 2	The display shows: the time of day  START	Step 3	Step 4	The display shows: --:--  STOP	Step 5	Step 6
							
Select the heating function.	Press repeatedly: 		Set the start time.	Press: OK , 		Set the end time.	Press: OK , 
 Timer starts counting down at a set start time.							

8. HOW TO USE: ACCESSORIES

8.1 Inserting accessories

A small indentation at the top increases safety. The indentations are also anti-tip devices. The high rim around the shelf prevents cookware from slipping off the shelf.

Wire shelf:

Push the shelf between the guide bars of the shelf support.

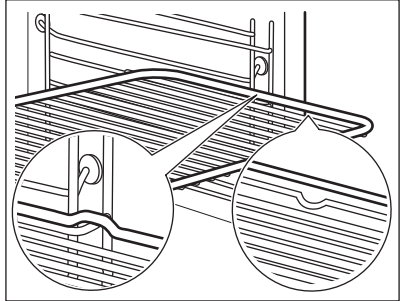
**Baking tray / Deep pan:**

Push the tray between the guide bars of the shelf support.

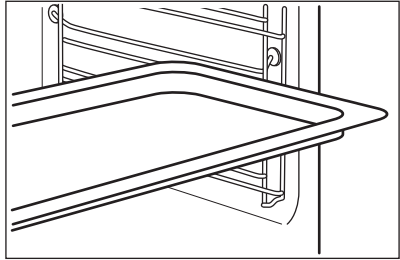
**Wire shelf, Baking tray / Deep pan:**

Push the tray between the guide bars of the shelf support and the wire shelf on the guide bars above.

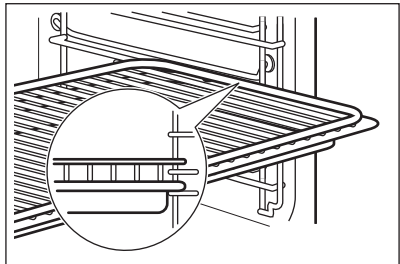

8.2 Food Sensor

Food Sensor- measures the temperature inside the food.

HOW TO USE: ACCESSORIES

There are two temperatures to be set:



The oven temperature.



The core temperature.

For the best cooking results:



Ingredients should be at room temperature.

Do not use it for liquid dishes.

During cooking it must remain in the dish.

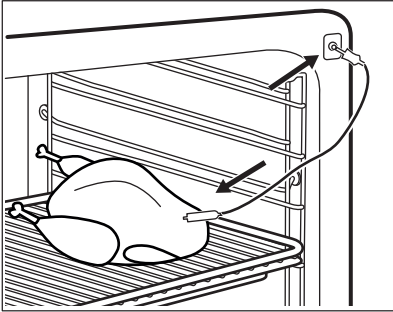
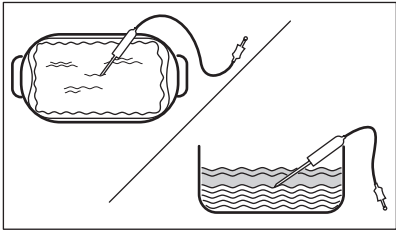





How to use: Food Sensor

Step 1	Turn on the oven.	
Step 2	Set a heating function and, if necessary, the oven temperature.	
Step 3	Insert: Food Sensor.	
Meat, poultry and fish	Casserole	
<p>Insert the tip of Food Sensor into the centre of meat, fish, in the thickest part if possible. Make sure that at least 3/4 of Food Sensor is inside of the dish.</p>	<p>Insert the tip of Food Sensor exactly in the centre of the casserole. Food Sensor should be stabilized in one place during baking. Use a solid ingredient to achieve that. Use the rim of the baking dish to support the silicone handle of Food Sensor. The tip of Food Sensor should not touch the bottom of a baking dish.</p>	
		
Step 4	Plug Food Sensor into the socket at the front of the oven. The display shows the current temperature of: Food Sensor.	

Step 5	 - press to set the core temperature of the sensor.
Step 6	OK - press to confirm. When food reaches the set temperature, the signal sounds. You can choose to stop or to continue cooking to make sure the food is well done.
Step 7	Remove Food Sensor plug from the socket and remove the dish from the oven. <div style="border: 1px solid black; padding: 5px;"> WARNING! There is a risk of burns as Food Sensor becomes hot. Be careful when you unplug it and remove it from the food.</div>



9. ADDITIONAL FUNCTIONS

9.1 Lock

This function prevents an accidental change of the oven function.		
Turn it on when the oven works - the set cooking continues, the control panel is locked. Turn it on when the oven is off - the oven cannot be turned on, the control panel is locked.		
  OK	 OK - press and hold to turn on the function. A signal sounds.	 OK - press and hold to turn it off.
 3 x  - flashes when the lock is turned on.		

9.2 Automatic switch-off

For safety reasons the oven turns off after some time, if a heating function works and you do not change any settings.

 (°C)	 (h)
30 - 115	12.5
120 - 195	8.5
200 - 245	5.5
250 - maximum	3

ADDITIONAL FUNCTIONS

The Automatic switch-off does not work with the functions: Light, Food sensor, Time Delay.

9.3 Cooling fan

When the oven operates, the cooling fan turns on automatically to keep the surfaces of the oven cool. If you turn off the oven, the cooling fan can continue to operate until the oven cools down.

9.4 Mechanical door lock

The door lock is unlocked when you buy the oven.

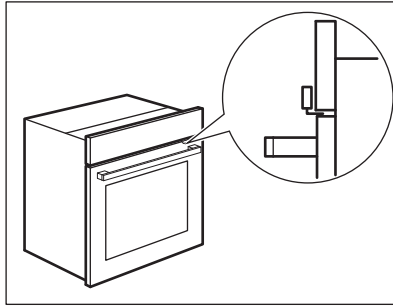

CAUTION!

Do not move the door lock vertically.
Do not push the door lock when you close the oven door.

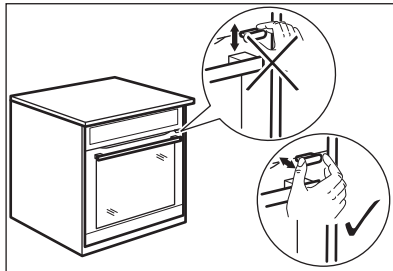

9.5 How to use: Mechanical door lock

Step 1

To lock the door pull the door lock forward until it locks.

Step 2

To unlock the door push the door lock back into the panel.

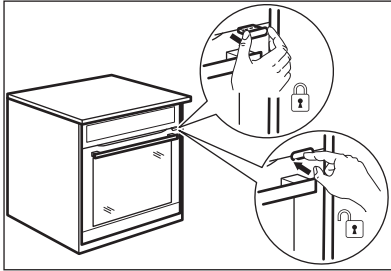

Opening the locked door

You can open the door when the door lock is locked.

Step 1

Push the door lock slightly and open the door by pulling it with the handle.

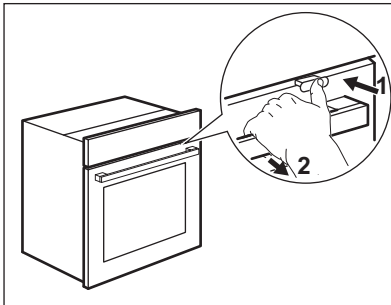



When you close the door make sure that the door lock remains locked.



10. HINTS AND TIPS

10.1 Moist Fan Baking

For the best results follow suggestions listed in the table below. Use the third shelf position.



	 (°C)	 (min)
Pasta gratin	200 - 220	45 - 55
Potato gratin	180 - 200	70 - 85

HINTS AND TIPS

	 (°C)	 (min)
Moussaka	170 - 190	70 - 95
Lasagne	180 - 200	75 - 90
Cannelloni	180 - 200	70 - 85
Bread pudding	190 - 200	55 - 70
Rice pudding	170 - 190	45 - 60
Apple cake, made of sponge cake mixture (round cake tin)	160 - 170	70 - 80
White bread	190 - 200	55 - 70

10.2 Moist Fan Baking - recommended accessories

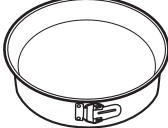
Use the dark and non-reflective tins and containers. They have better heat absorption than the light colour and reflective dishes.

			
Pizza pan	Baking dish	Ramekins	Flan base tin
Dark, non-reflective 28 cm diameter	Dark, non-reflective 26 cm diameter	Ceramic 8 cm diameter, 5 cm height	Dark, non-reflective 28 cm diameter





10.3 Cooking tables for test institutes

Information for test institutes

Tests according to: EN 60350, IEC 60350.



BAKING ON ONE LEVEL. Baking in tins





		 (°C)	 (min)	
Fatless sponge cake	True Fan Cooking	140 - 150	35 - 50	2
Fatless sponge cake	Conventional Cooking	160	35 - 50	2
Apple pie, 2 tins Ø20 cm	True Fan Cooking	160	60 - 90	2
Apple pie, 2 tins Ø20 cm	Conventional Cooking	180	70 - 90	1



BAKING ON ONE LEVEL. Biscuits







Use the third shelf position.

		 (°C)	 (min)
Short bread / Pastry strips	True Fan Cooking	140	25 - 40
Short bread / Pastry strips, preheat the empty oven	Conventional Cooking	160	20 - 30
Small cakes, 20 per tray, preheat the empty oven	True Fan Cooking	150	20 - 35
Small cakes, 20 per tray, preheat the empty oven	Conventional Cooking	170	20 - 30

CARE AND CLEANING



MULTILEVEL BAKING. Biscuits

		 (°C)	 (min)	
Short bread / Pastry strips	True Fan Cooking	140	25 - 45	1 / 4
Small cakes, 20 per tray, preheat the empty oven	True Fan Cooking	150	23 - 40	1 / 4
Fatless sponge cake	True Fan Cooking	160	35 - 50	1 / 4







GRILL



Preheat the empty oven for 5 minutes.



Grill with the maximum temperature setting.

		 (min)	
Toast	Grill	1 - 3	5
Beef steak, turn halfway through	Grill	24 - 30	4



11. CARE AND CLEANING



WARNING!

Refer to Safety chapters.

11.1 Notes on cleaning

 <p>Cleaning Agents</p>	Clean the front of the oven with a soft cloth with warm water and a mild detergent.
	Use a cleaning solution to clean metal surfaces.
	Clean stains with a mild detergent. Do not apply it on the catalytic surfaces.
 <p>Everyday Use</p>	Clean the cavity after each use. Fat accumulation or other residue may cause fire.
	Do not store the food in the oven for longer than 20 minutes. Dry the cavity with a soft cloth after each use.
 <p>Accessories</p>	Clean all accessories after each use and let them dry. Use a soft cloth with warm water and a mild detergent. Do not clean the accessories in a dishwasher.
	Do not clean the non-stick accessories using abrasive cleaner or sharp-edged objects.

11.2 How to clean: Cavity embossment

Clean the cavity embossment to remove limestone residue after cooking with steam.

Step 1	Step 2	Step 3
Pour: 250 ml of white vinegar into the cavity embossment. Use maximum 6% vinegar without any additives.	Let the vinegar dissolve the limestone residue at the ambient temperature for 30 minutes.	Clean the cavity with warm water and a soft cloth.
For the function: SteamBake clean the oven for every 5 - 10 cooking cycles.		

11.3 How to remove: Shelf supports

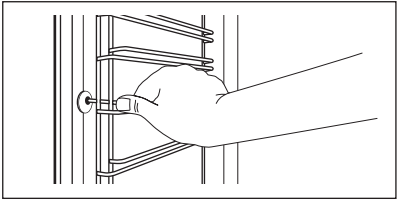
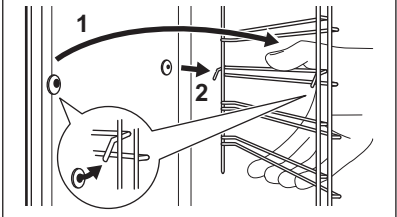

Remove the shelf supports to clean the oven.

CARE AND CLEANING

Step 1	Turn off the oven and wait until it is cold.	
Step 2	Pull the front of the shelf support away from the side wall.	
Step 3	Pull the rear end of the shelf support away from the side wall and remove it.	
Step 4	Install the shelf supports in the opposite sequence.	

11.4 How to use: Catalytic cleaning

The cavity is coated with catalytic enamel. It absorbs fat during catalysis. Spots or discolouration of the catalytic coating have no effect on the cleaning.

Clean the oven with catalytic cleaning		
Before the catalytic cleaning remove all accessories.		
Step 1	Step 2	Step 3
Select Menu  / Cleaning  and press OK.	When the cleaning ends the signal sounds. The oven turns off.	When the oven is cold, clean the cavity with a wet soft cloth.
Duration: 1 h.		

11.5 How to remove and install: Door

You can remove the door and the internal glass panels to clean it. The number of glass panels is different for different models.

	WARNING! The door is heavy.
--	---------------------------------------

	CAUTION! Carefully handle the glass, especially around the edges of the front panel. The glass can break.
--	---

CARE AND CLEANING

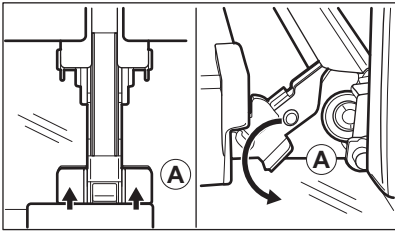
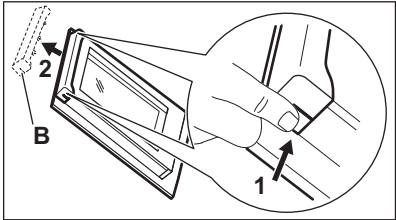
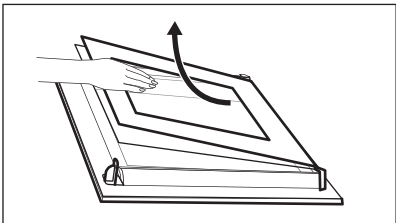
Step 1	Fully open the door.	
Step 2	Lift and press the clamping levers (A) on the two door hinges.	
Step 3	Close the oven door to the first opening position (approximately 70° angle). Hold the door at both sides and pull it away from the oven at an upwards angle. Put the door with the outer side down on a soft cloth on a stable surface.	
Step 4	Hold the door trim (B) on the top edge of the door at the two sides and push inwards to release the clip seal.	
Step 5	Pull the door trim to the front to remove it.	
Step 6	Hold the door glass panels on their top edge one by one and pull them up out of the guide.	
Step 7	Clean the glass panel with water and soap. Dry the glass panel carefully. Do not clean the glass panels in the dishwasher.	
Step 8	After cleaning, do the above steps in the opposite sequence.	
Step 9	Install the smaller panel first, then the larger and the door. Make sure that the glasses are inserted in the correct position otherwise the surface of the door may overheat.	

11.6 How to replace: Lamp



WARNING!

Risk of electric shock.
The lamp can be hot.

TROUBLESHOOTING

Before you replace the lamp:

Step 1	Step 2	Step 3
Turn off the oven. Wait until the oven is cold.	Disconnect the oven from the mains.	Put a cloth on the bottom of the cavity.

Top lamp

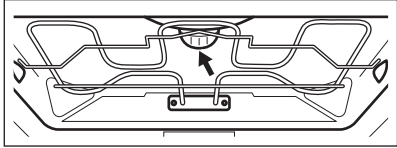
Step 1	Turn the glass cover to remove it.	
Step 2	Clean the glass cover.	
Step 3	Replace the lamp with a suitable 300 °C heat-resistant lamp.	
Step 4	Install the glass cover.	

Side lamp

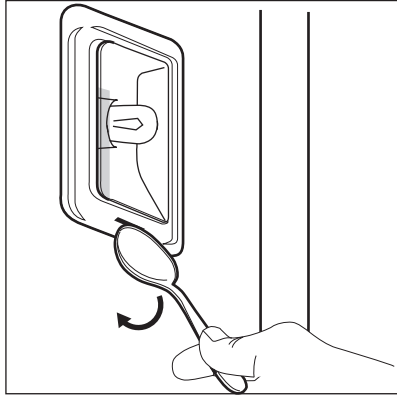
Step 1	Remove the left shelf support to get access to the lamp.	
Step 2	Use a narrow, blunt object (e.g. a teaspoon) to remove the glass cover.	
Step 3	Clean the glass cover.	
Step 4	Replace the lamp with a suitable 300 °C heat-resistant lamp.	
Step 5	Install the glass cover.	
Step 6	Install the left shelf support.	

12. TROUBLESHOOTING





WARNING!

Refer to Safety chapters.

12.1 What to do if...

In any cases not included in this table please contact with an Authorised Service Centre.

 The oven does not turn on or does not heat up	
Problem	Check if...
You cannot activate or operate the oven.	The oven is correctly connected to an electrical supply.
The oven does not heat up.	The automatic switch-off is deactivated.
The oven does not heat up.	The fuse is not blown.
The oven does not heat up.	The Child Lock is off.

 Components	
Problem	Check if...
The lamp is turned off.	Moist Fan Baking - is turned on.
The lamp does not work.	The lamp is burnt out.
The Food sensor does not operate.	The plug of the Food sensor is fully inserted into the socket.

 Error codes	
The display shows...	Check if...
Err C2	You removed the Food sensor plug from the socket.
00:00	There was a power cut. Set the time of day.
If the display shows an error code that is not in this table turn the house fuse off and on to restart the oven. If the error code recurs contact an Authorised Service Centre.	

ENERGY EFFICIENCY



Cleaning

Problem	Check if...
The water leaks out of the cavity embossment.	There is too much water in the cavity embossment.

12.2 Service data

If you cannot find a solution to the problem yourself, contact your dealer or an Authorised Service Centre.

The necessary data for the service centre is on the rating plate. The rating plate is on the front frame of the oven cavity. Do not remove the rating plate from the oven cavity.

We recommend that you write the data here:	
Model (MOD.)
Product number (PNC)
Serial number (S.N.)

13. ENERGY EFFICIENCY

13.1 Product Information and Product Information Sheet*

Supplier's name	Electrolux
Model identification	COC826X 944032024
Energy Efficiency Index	81.2
Energy efficiency class	A+
Energy consumption with a standard load, conventional mode	1.09 kWh/cycle
Energy consumption with a standard load, fan-forced mode	0.69 kWh/cycle
Number of cavities	1

Heat source	Electricity
Volume	71 l
Type of oven	Built-In Oven
Mass	33.0 kg

* For European Union according to EU Regulations 65/2014 and 66/2014.
 For Republic of Belarus according to STB 2478-2017, Appendix G; STB 2477-2017, Annexes A and B.
 For Ukraine according to 568/32020.

Energy efficiency class is not applicable for Russia.

EN 60350-1 - Household electric cooking appliances - Part 1: Ranges, ovens, steam ovens and grills - Methods for measuring performance.

13.2 Energy saving



The oven has features which help you save energy during everyday cooking.

Make sure that the oven door is closed when the oven operates. Do not open the oven door too often during cooking. Keep the door gasket clean and make sure it is well fixed in its position.

Use metal cookware to improve energy saving.

When possible, do not preheat the oven before cooking.

Keep breaks between baking as short as possible when you prepare a few dishes at one time.

Cooking with fan

When possible, use the cooking functions with fan to save energy.

Residual heat

The fan and lamp continue to operate. When you turn off the oven, the display shows the residual heat. You can use that heat to keep the food warm.

When the cooking duration is longer than 30 min, reduce the oven temperature to minimum 3 - 10 min before the end of cooking. The residual heat inside the oven will continue to cook.

Use the residual heat to warm up other dishes.

Keep food warm

Choose the lowest possible temperature setting to use residual heat and keep a meal warm.

The residual heat indicator or temperature appears on the display.

Cooking with the lamp off

Turn off the lamp during cooking. Turn it on only when you need it.

Moist Fan Baking



Function designed to save energy during cooking.



When you use this function the lamp automatically turns off after 30 sec. You may turn on the lamp again but this action will reduce the expected energy savings.







MENU STRUCTURE

14. MENU STRUCTURE

14.1 Menu



	 - select to enter the Menu.
---	---

Menu structure		
Assisted Cooking 	Cleaning 	Settings 

Step 1	Step 2	Step 3	Step 4	Step 5
 	 OK	 O1 - O14	 OK	
Select the Menu, Settings.	Confirm setting.	Select the setting.	Confirm setting.	Adjust the value and press OK.

Settings					
O1	Time of day	Change	O2	Display brightness	1 - 5
O3	Key tones	1 - Beep 2 - Click 3 - Sound off	O4	Buzzer volume	1 - 4
O5	Food Sensor Action	1 - Alarm and stop 2 - Alarm	O6	Uptimer	On / Off
O7	Light	On / Off	O8	Fast Heat Up	On / Off
O9	Wi-Fi	On / Off	O10	Auto remote operation	On / Off
O11	Forget network	Yes / No	O12	Demo mode	Activation code: 2468
O13	Software version	Check	O14	Reset all settings	Yes / No

15. ENVIRONMENTAL CONCERNS

Recycle materials with the symbol . Put the packaging in relevant containers to recycle it. Help protect the environment and human health by recycling waste of electrical and electronic appliances. Do not dispose of appliances marked with the symbol  with the household waste. Return the product to your local recycling facility or contact your municipal office.

SINUN PARHAAKSESI

Kiitos, kun valitsit Electrolux-laitteen. Olet valinnut tuotteen, joka perustuu vuosikymmenien aikana hankittuun kokemukseen ja innovaatioon. Kekseliäs ja tyylikäs laite, joka on suunniteltu sinua varten. Laitetta käyttäessäsi voit olla aina varma erinomaisista tuloksista. Tervetuloa Electroluxiin.

Vieraile verkkosivullamme:



Saat käyttöön liittyviä neuvoja, esitteitä, vianmääritysohjeita sekä huolto- ja korjausohjeita:

www.electrolux.com/support



Rekisteröi tuotteesi saadaksesi parempaa huoltoa:

www.registerelectrolux.com



Osta laitteeseesi lisävarusteita, kulutustuotteita ja alkuperäisiä varaosia:

www.electrolux.com/shop



Saat lisää reseptejä, vinkkejä, vianetsintäohjeita lataamalla **My Electrolux Kitchen** sovellus.



ASIAKASPALVELU

Käytä aina alkuperäisiä varaosia.

Pidä seuraavat tiedot saatavilla ottaessasi yhteyttä valtuutettuun huoltoliikkeeseemme: Malli, PNC-tuotenumero, sarjanumero.

Tiedot löytyvät arvokilvestä.

 Varoitus / Varotoimi- ja turvallisuustietoja

 Yleistietoa ja vinkkejä

 Ympäristönsuojelutietoja

Oikeus muutoksiin pidätetään.

SISÄLTÖ

1. TURVALLISUUSTIEDOT.....	82	2.7 Hävittäminen.....	87
1.1 Lasten ja taitamattomien henkilöiden turvallisuus.....	82	3. TUOTEKUVAUS.....	87
1.2 Yleinen turvallisuus.....	83	3.1 Yleiskatsaus.....	88
2. TURVALLISUUSOHJEET.....	84	3.2 Varusteet.....	88
2.1 Asennus.....	84	4. UUNIN KYTKEMINEN PÄÄLLE JA POIS PÄÄLTÄ.....	89
2.2 Sähkökytkentä.....	85	4.1 Sisäänpainettava vääntimet.....	89
2.3 Valitse.....	85	4.2 Käyttöpaneeli.....	90
2.4 Hoito ja puhdistus.....	86		
2.5 Sisävalo.....	87		
2.6 Huoltopalvelu.....	87		

5. ENNEN ENSIKÄYTTÖÄ.....	91	10. VIHJEITÄ JA NEUVOJA.....	107
5.1 Alkupuhdistus.....	91	10.1 Kosteaa kiertoilma.....	108
5.2 Alustava esikuumennus.....	91	10.2 Kosteaa kiertoilma -	
5.3 Langaton yhteys 	92	suositellut varusteet.....	108
5.4 Ohjelmistolisenssit.....	92	10.3 Testilaitosten	
6. PÄIVITTÄINEN KÄYTTÖ.....	92	ruoanvalmistustaulukot.....	109
6.1 Asetukset: Uunitoiminnot.....	93	11. HOITO JA PUHDISTUS.....	110
6.2 Uunitoiminnot.....	94	11.1 Puhdistukseen liittyviä	
6.3 Huomautus: Kosteaa kiertoilma.....	95	huomautuksia.....	111
6.4 Asetukset: Avustava		11.2 Puhdistaminen: Lokeron reliefi..	111
ruoanvalmistus.....	95	11.3 Irrottaminen: Kannattimet	111
6.5 Avustava ruoanvalmistus		11.4 Käyttöohje: Katalyysipuhdistus .	112
sisältää reseptejä.....	96	11.5	
7. KELLOTOIMINNOT.....	101	Irrottaminen ja asentaminen: Luukku.	112
7.1 Kellotoiminnot.....	101	11.6 Vaihtaminen: Lamppu.....	113
7.2 Asetukset: Kellotoiminnot.....	102	12. VIANNÄÄRITYS.....	114
8. KÄYTTÖOHJEET: LISÄVARUSTEET....	103	12.1 Käyttöhäiriöt.....	115
8.1 Lisävarusteiden asennus.....	103	12.2 Huoltotiedot.....	116
8.2 Paistolämpömittari.....	104	13. ENERGIATEHOKKUUS.....	116
9. LISÄTOIMINNOT.....	105	13.1 Tuotetiedot ja tuotteen	
9.1 Lukko.....	105	tietolomake*.....	116
9.2 Automaattinen virrankatkaisu.....	106	13.2 Energiansäästö.....	117
9.3 Jäähdytyspuhallin.....	106	14. VALIKKORAKENNE.....	117
9.4 Mekaanin luukun lukko.....	106	14.1 Valikko.....	118
9.5 Käyttöohje: Mekaanin luukun			
lukko.....	107		

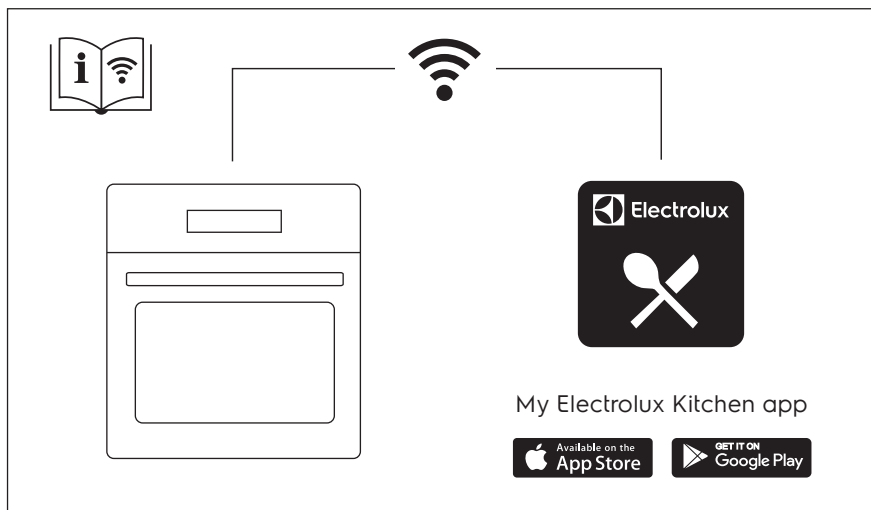

1. ⚠️ TURVALLISUUSTIEDOT

Lue laitteen mukana toimitetut ohjeet ennen laitteen asennusta ja käyttöä. Valmistaja ei ota vastuuta henkilövahingoista tai vahingoista, jotka aiheutuvat virheellisestä asennuksesta tai käytöstä. Säilytä ohjeita aina varmassa ja helppopääsyisessä paikassa tulevia käyttökertoja varten.

1.1 Lasten ja taitamattomien henkilöiden turvallisuus

- 8-vuotiaat ja sitä vanhemmat lapset sekä henkilöt, joilla on fyysisiä, aisteihin liittyviä tai henkisiä rajoitteita tai puutteellinen kokemus tai tuntemus, voivat käyttää tätä laitetta vain, jos heitä valvotaan tai ohjataan laitteen turvallisessa käytössä ja jos he ymmärtävät käyttöön liittyvät vaarat. Tuote on pidettävä alle 8-vuotiaiden lasten ja erittäin laajoista ja monimutkaisista toiminnallisista rajoitteista kärsivien henkilöiden ulottumattomissa, ellei heitä valvota jatkuvasti.
- Lapsia on valvottava, jotta he eivät ryhdy leikkimään laitteella ja mobiililaitteilla My Electrolux Kitchen.

- Kaikki pakkaukset tulee pitää lasten ulottumattomissa ja hävittää asianmukaisesti.
- VAROITUS: Pidä lapset ja lemmikkieläimet pois uunin lähetyviltä sen ollessa toiminnassa tai jäähtymässä käytön jälkeen. Laitteen esillä olevat osat kuumentuvat käytön aikana.
- Jos laitteessa on lapsilukko, sitä on käytettävä.
- Lapset eivät saa puhdistaa laitetta tai suorittaa siihen kohdistuvia käyttäjän huoltotoimenpiteitä ilman valvontaa.

1.2 Yleinen turvallisuus

- Laitteen asennuksen ja virtajohdon vaihtamisen saa suorittaa vain alan ammattilainen.
- Älä käytä laitetta ennen kuin se on asennettu kalusteeseen.
- Irrota laite sähköverkosta ennen huoltotoimenpiteiden suorittamista.
- Jos virtajohto vaurioituu, sen saa sähkövaaran välttämiseksi vaihtaa vain valmistaja, valtuutettu huoltoliike tai vastaava ammattitaitoinen henkilö.
- VAROITUS: Varmista ennen lampun vaihtoa, että laite on pois päältä. Näin vältät mahdollisen sähköiskun.
- VAROITUS: Laite ja näkyvissä olevat osat kuumenevat käytön aikana. Varo koskettamasta uunin lämmitysvastuksia.
- Käytä aina uunikintaita, kun käsittelet lisävarusteita tai uunivuokia.
- Käytä ainoastaan tähän laitteeseen suositeltua paistolämpömittaria.
- Poista kannatinkiskot vetämällä ensin kannatinkiskon etuosasta ja sen jälkeen takaosa irti sivuseinistä. Kiinnitä kannattimet takaisin paikalleen suorittamalla toimenpiteet päinvastaisessa järjestyksessä.
- Laitteen puhdistuksessa ei saa käyttää painepesuria.

- Älä käytä hankausaineita tai teräviä metallikaapimia lasiluukun puhdistamisessa, sillä ne voivat naarmuttaa pintaa, mistä voi olla seurauksena luukun lasin särkyminen.

2. TURVALLISUUSOHJEET

2.1 Asennus

**VAROITUS!**

Asennuksen saa suorittaa vain ammattitaitoinen henkilö.

- Poista kaikki pakkausmateriaalit.
- Vaurioitunutta laitetta ei saa asentaa tai käyttää.
- Noudata koneen mukana toimitettuja asennusohjeita.
- Siirrä laitetta aina varoen, sillä se on raskas. Käytä aina suojakäsineitä ja suojaavia jalkineita.
- Älä koskaan vedä laitetta sen kahvasta kiinni pitäen.
- Asenna laite turvalliseen ja sopivaan paikkaan, joka täyttää asennusvaatimukset.
- Noudata mainittuja vähimmäisetäisyyksiä muihin laitteisiin ja kalusteisiin.
- Tarkista ennen laitteen asentamista, että uuninluukku avautuu esteettä.
- Laite on varustettu sähkötoimisella jäähdytysjärjestelmällä. Sitä on käytettävä sähkösyötöllä.
- Kalusteisiin asennettavan yksikön on täytettävä standardin DIN 68930 asettamat vaatimukset.

Kaapin vähimmäiskorkeus (työtason alla olevan kaapin vähimmäiskorkeus)	578 (600) mm
Kaapin leveys	560 mm
Kaapin syvyys	550 (550) mm
Laitteen etuosan korkeus	594 mm
Laitteen takaosan korkeus	576 mm
Laitteen etuosan leveys	595 mm
Laitteen takaosan leveys	559 mm
Laitteen syvyys	567 mm
Laitteen asennussyvyys	546 mm
Leveys luukun ollessa auki	1027 mm

Tuuletusaukon vähimmäiskoko. Aukko alaosassa takana	560 x 20 mm
Virtajohdon pituus. Johto sijaitsee oikeassa kulmassa takana	1500 mm
Kiinnitysruuvit	4 x 25 mm

2.2 Sähkökytkentä



VAROITUS!

Tulipalo- ja sähköiskuvaara.

- Kaikki sähkökytkennät tulee jättää asiantuntevan sähköasentajan vastuulle.
- Laite on kytkettävä maadoitettuun pistorasiaan.
- Varmista, että arvokilvessä olevat parametrit ovat verkkovirtalähteen sähköarvojen mukaisia.
- Kytke pistoke maadoitettuun pistorasiaan.
- Älä käytä jakorasioita tai jatkojohtoja.
- Varmista, ettei pistoke ja virtajohto vaurioidudu. Jos virtajohto joudutaan vaihtamaan, vaihdon saa suorittaa vain valtuutettu huoltoliike.
- Älä anna virtajohtojen koskettaa laitteen luukkuja tai päästä niitä luukun tai laitteen alapuolella olevan asennustilan lähelle, varsinkaan laitteen ollessa toiminnassa tai luukun ollessa kuuma.
- Jännitteenalaisten ja eristettyjen osien suoja- ja eristysosat tulee asentaa niin, ettei niiden irrotus onnistu ilman työkaluja.
- Kytke pistoke pistorasiaan vasta asennuksen jälkeen. Varmista, että laitteen verkkovirtakytkentä on ulottuvilla laitteen asennuksen jälkeen.
- Jos pistoke on löysästi kiinni virtajohdossa, älä kiinnitä sitä pistorasiaan.
- Älä vedä virtajohdosta pistoketta irrottaessasi. Vedä aina pistokkeesta.
- Käytä vain asianmukaisia eristyslaitteita: suojakytkimet, sulakkeet (ruuvattavat sulakkeet on irrotettava kannasta), vikavirtakytkimet ja kontaktorit.
- Sähköasennuksessa on oltava erotin, joka mahdollistaa laitteen irrottamisen sähköverkosta kaikista navoista. Erotin kontaktiaukon leveys on oltava vähintään 3 mm.
- Laitteen mukana toimitetaan päävirtajohto ja pääpistoke.

2.3 Valitse



VAROITUS!

Henkilövahinkojen, palovammojen ja sähköiskujen tai räjähdysvaara.

- Tämä laite on tarkoitettu ainoastaan kotitalouskäyttöön.
- Älä muuta laitteen teknisiä ominaisuuksia.
- Varmista, että tuuletusaukoissa ei ole tukoksia.
- Laitetta ei saa jättää päälle valvomatta.
- Kytke laite pois päältä jokaisen käyttökerran jälkeen.
- Noudata varovaisuutta avatessasi laitteen luukun laitteen ollessa toiminnassa. Laitteesta voi purkautua ulos kuumaa ilmaa.
- Älä käytä laitetta, jos kätesi ovat märät tai laitteen ollessa kosketuksessa veteen.

- Älä kohdistaa painetta avoimeen oveen.
- Älä käytä laitetta työtasona tai tavaroiden säilytystasona.
- Avaa laitteen luukku varovaisuutta noudattaen. Alkoholi- ja muiden ainesosien käyttämisen tuloksena voi muodostua alkoholin ja ilman seoksia.
- Älä päästä kipinöitä tai avotulta kosketukseen laitteen kanssa avatessasi sen luukun.
- Älä aseta helposti syttyviä tuotteita tai helposti syttyvien aineiden kanssa kosketuksissa olleita tuotteita laitteeseen, laitteen päälle tai sen lähelle.
- Älä jaa Wi-Fi-salasanaasi muille.



VAROITUS!

Laite voi muutoin vaurioitua.

- Estä emalipinnan vaurioituminen tai haalistuminen:
 - Älä aseta ruoanlaittovälineitä tai muita esineitä laitteeseen siten, että ne olisivat suorassa kosketuksessa laitteen pohjan kanssa.
 - Älä aseta alumiinifoliota siten, että se olisi suorassa kosketuksessa laitteen pohjan kanssa.
 - Älä laita vettä suoraan kuumaan laitteeseen.
 - Älä säilytä kosteita astioita tai ruokia laitteessa lopetettuasi ruoanlaiton.
 - Noudata varovaisuutta poistaessasi tai asentaessasi lisäosia.
- Uunin emalipintojen tai ruostumattoman teräksen värimuutokset eivät vaikuta laitteen toimintaan.
- Käytä syvää pannua kosteita kakkuja paistaessasi. Hedelmämehut voivat jättää pysyviä tahroja.
- Tämä laite on tarkoitettu ainoastaan ruoanlaittoon. Laitetta ei saa käyttää muihin tarkoituksiin, kuten esimerkiksi huoneen lämmittämiseen.
- Laitteen luukku on pidettävä suljettuna käytön aikana.
- Jos laite asennetaan kalusteen paneelin (esim. oven) taakse, ovea ei saa koskaan sulkea laitteen ollessa toiminnassa. Lämpöä tai kosteutta voi kertyä suljetun kalusteen paneelin taakse ja laite, kalusteet tai lattia voivat sen seurauksena vaurioitua. Älä sulje kalusteen paneelia ennen kuin laite on täysin jäähtynyt käytön jälkeen.

2.4 Hoito ja puhdistus



VAROITUS!

Ne voivat aiheuttaa henkilövahinkoja, tulipaloja tai laitteen vaurioitumisen.

- Kytke laite pois toiminnasta ja irrota pistoke pistorasiasta ennen ylläpitotoimien aloittamista.
- Tarkista, että laite on kylmä. Vaarana on lasilevyjen rikkoutuminen.
- Vaihda välittömästi vaurioituneet luukun lasipaneelit. Ota yhteyttä valtuutettuun huoltoliikkeeseen.
- Ole varovainen irrottaessasi luukkuja. Luukku on painava!
- Puhdista laite säännöllisesti, jotta pintamateriaali ei vaurioidu.
- Puhdista laite kostealla pehmeällä liinalla. Käytä ainoastaan mietoja pesuaineita. Älä käytä hankausainetta, hankaavia pesulappuja, liuottimia tai metalliesineitä.
- Jos käytät uuninpuhdistussuihketta, noudata tuotepakkauksessa olevia turvallisuusohjeita.
- Älä puhdista katalyyttistä emalia pesuaineella.

2.5 Sisävalo

**VAROITUS!**

Sähköiskun vaara.

- Lisätietoa tämän tuotteen sisällä olevista lampuista sekä erikseen myytävistä varalampuista: Kyseiset lamput on suunniteltu kestävämmän kodinkoneissa vaativia fyysisiä olosuhteita (esim. lämpötila, värinä, kosteus) tai ne antavat tietoa laitteen toimintatilasta. Niitä ei ole tarkoitettu muihin käyttötarkoituksiin eivätkä ne sovi huoneiden valaisemiseen.
- Käytä ainoastaan ominaisuuksiltaan samanlaisia lamppuja.

2.6 Huoltopalvelu

- Kun laite on korjattava, ota yhteyttä valtuutettuun huoltopalveluun.
- Käytä vain alkuperäisiä varaosia.

2.7 Hävittäminen

**VAROITUS!**

Henkilövahinko- tai tukehtumisvaara.

- Irrota pistoke pistorasiasta.
- Leikkaa virtajohto laitteen läheltä ja hävitä se.
- Poista luukun lukitus, jotta lapset ja eläimet eivät voisi jäädä kiinni laitteen sisälle.

3. TUOTEKUVAUS

3.1 Yleiskatsaus

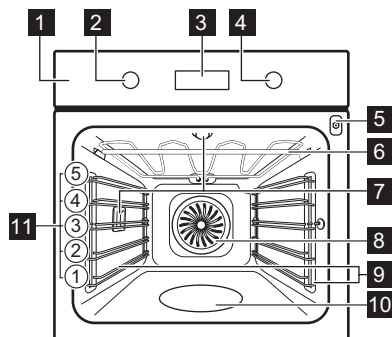

- 1** Käyttöpaneeli
- 2** Uunitoimintojen kiertonuppi
- 3** Näyttö
- 4** Säätonuppi
- 5** Paistolämpömittarin pistorasia
- 6** Lämpövastus
- 7** Lamppu
- 8** Puhallin
- 9** Hyllykannatin, irrotettava
- 10** Lokero
- 11** Hyllytasot

3.2 Varusteet

Paistoritilä

Ruoanlaittovälineille, kakkuvuokat, paistit.

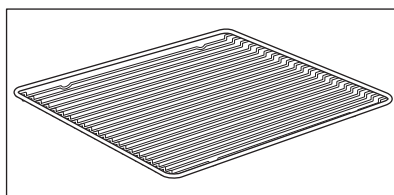

UUNIN KYTKEMINEN PÄÄLLE JA POIS PÄÄLTÄ.

Leivinpelti

Kakuille ja kekseille.

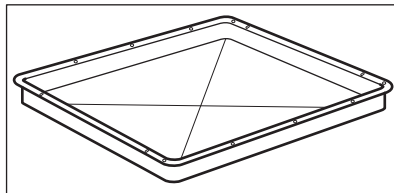

Grilli / uunipannu

Paistamiseen tai pannuna rasvan keräämiseen.

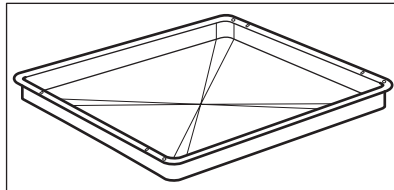

Ammattilaispelti

Käytetään sämpylöiden ja muiden pienten leivonnaisten paistamiseen. Soveltuu höyrytystoimintoihin. Pinnan värimuutokset eivät vaikuta toimintoihin.

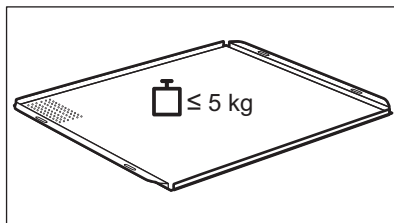

Paistolämpömittari

Ruoan sisälämpötilan mittaamiseen.

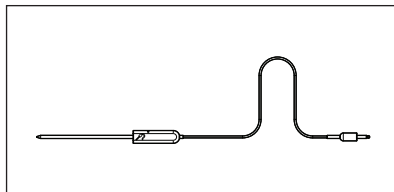







4. UUNIN KYTKEMINEN PÄÄLLE JA POIS PÄÄLTÄ.











4.1 Sisäänpainettava vääntimet









Paina väännintä käyttäaksesi laitetta. Väännin tulee ulos.





UUNIN KYTKEMINEN PÄÄLLE JA POIS PÄÄLTÄ.

4.2 Käyttöpaneeli

Käyttöpaneelin kosketuskentät					Paina	Kierrä nappivalitsinta
 Ajastin	 Pikakuu- mennus	 Uuni- valo	 Paistolämpö- mittarin kanssa	OK		
Kytke uuni päälle valitsemalla uunitoiminto.						
Kytke uuni pois päältä kääntämällä uunitoimintojen nappivalitsin Off (pois päältä) -asentoon.						

 12:34	Kun uunitoimintojen nappivalitsin on Off (pois päältä) -asennossa, näyttö siirtyy valmistustilaan.
 12:34 180°	Asetettu lämpötila, kellonaika ja muut käytettävissä olevat valinnat näkyvät näytössä kypsennyksen aikana.
        88:88:8888 g >> DEMO h:min:s	Näyttö enimmäismäärällä asetettuja toimintoja.





Näytön merkkivalot				
 Lukko	 Avustava ruoan- valmistus	 Puhdistus	 Asetukset	 Pikakuu- mennus
Ajastimen merkkiva- lot:		 STOP		
Wi-Fi-yhteys merkkivalo – vilkkuu, kun uuniin voidaan muodostaa Wi-Fi-yhteys.			Etäohjaus -merkkivalo – uunia voidaan etäohjata.	

 Wi-Fi-yhteys -yhteys on kytketty päälle.	 Etäohjaus on kytketty toimintaan.
Edistymistä osoittava palkki – lämpötilan tai ajan kulumisen seuraamiseen.	
Höyrykypsentämisen merkkivalo	
Paistolämpömittari merkkivalo	





5. ENNEN ENSIKÄYTTÖÄ

	VAROITUS! Lue turvallisuutta koskevat luvut.
--	--

5.1 Alkupuhdistus

Ennen ensikäyttöä tyhjä uuni täytyy puhdistaa ja sen kelloon on asetettava seuraava arvo:			
			 00:00 Aseta aika. Paina OK .

5.2 Alustava esikuumennus

	Esikuumenna tyhjä uuni ennen ensimmäistä käyttökertaa.
1. vaihe	Poista kaikki lisävarusteet ja irrotettavat uunipeltien kannattimet uunista.
2. vaihe	Aseta toiminnon maksimilämpötila:  Anna uunin käydä yhden tunnin ajan.
3. vaihe	Aseta toiminnon maksimilämpötila:  Anna uunin käydä 15 minuutin ajan.
 Uunista voi tulla hajua ja savua esikuumennuksen aikana. Varmista tilan hyvä tuuletus.	

5.3 Langaton yhteys

Uuniin yhdistämiseen tarvitset:

- langattoman verkon Internet-yhteydellä
- Mobiililaitteen, joka on yhdistetty langattomaan verkkoon.

1. vaihe	Lataa mobiilisovellus My Electrolux Kitchen ja noudata seuraaviin vaiheisiin liittyviä ohjeita.
2. vaihe	Valitse kiertämällä nuppia:  :

Taajuus	2,4 GHz WLAN	5 GHz WLAN
	2400 - 2483,5 MHz	5150–5350 MHz 5470–5725 MHz
Protokolla	IEEE 802.11b DSSS/ 802.11g/n OFDM	IEEE 802.11 a/n OFDM
Enimmäisteho	EIRP < 20 dBm (100 mW)	EIRP < 23 dBm (200 mW)
Wi-Fi-moduuli	NIU5-50	

Taajuus Bluetooth	2400 - 2483,5 MHz
Protokolla	LE: DSSS
Enimmäisteho	EIRP < 4 dBm (2,5 mW)

Direktiivin 2014/53/EU piiriin kuuluvat EU-jäsenvaltiot: Belgia, Bulgaria, Tšekin tasavalta, Tanska, Saksa, Viro, Irlanti, Kreikka, Espanja, Ranska, Kroatia, Italia, Kypros, Latvia, Liettua, Luxemburg, Unkari, Malta, Alankomaat, Itävalta, Puola, Portugali, Romania, Slovenia, Slovakia, Suomi, Ruotsi, Norja, Sveitsi, Yhdistynyt kuningaskunta, Turkki.

5.4 Ohjelmistolisenssit

Tämän tuotteen ohjelmisto sisältää komponentteja, jotka perustuvat ilmaisohjelmistoihin ja avoimen lähdekoodin ohjelmistoihin. Electrolux kiitollisena ilmoittaa, että kehittämissuorituksissa on käytetty avoimen lähdekoodin ohjelmistoja ja robotiikkayhteisöjen osallistumista.

Jos haluat käyttää näiden ilmaisten ja avoimen lähdekoodin ohjelmistojen komponentteja, joiden käyttöoikeusehdot edellyttävät julkaisemista, ja nähdä kaikki ao. tekijänoikeustiedot ja sovellettavat käyttöoikeusehdot, vieraile sivustoilla: <http://electrolux.opensoftwarerepository.com> (kansio NIU5).

6. PÄIVITTÄINEN KÄYTTÖ



VAROITUS!

Lue turvallisuutta koskevat luvut.

6.1 Asetukset: Uunitoiminnot

Ruoanlaiton aloitus	
1. vaihe	2. vaihe
Aseta kuumennustoiminto.	Aseta lämpötila.

Höyrykypsennys			
Varmista, että laite on jäähtynyt.			
1. vaihe	2. vaihe	3. vaihe	4. vaihe
			Esikuumenna tyhjää uunia 10 minuuttia kosteuden muodostamiseksi. Aseta ruoka-aineet uuniin.
Täytä lokero hanavedellä.	Aseta höyryuunitoiminto.	Aseta lämpötila.	
ⓘ Lokeron enimmäistilavuus on 250 ml. Lokeroon ei saa lisätä vettä käytön aikana tai uunin ollessa kuuma.			







Kun höyryuunitoiminto on päättynyt:		
1. vaihe	2. vaihe	3. vaihe



Kun höyryuunitoiminto on päättynyt:

Kytke uunin virta pois päältä kääntämällä uunitoimintojen nappivalitsin Off (virta pois päältä) -asentoon.	Vaa luukku kokonaan varovasti. Laitteesta purkautuva kosteus voi aiheuttaa palovammoja.	Varmista, että laite on jäähtynyt. Poista lokeroon jäänyt vesi.
--	---	---

6.2 Uunitoiminnot

Vakiouunitoiminnot

Uunitoiminto	Sovellus
 Kierroilma	Korkeintaan kolmella kannatintasolla kypsentäminen samanaikaisesti ja ruokien kuivaus. Aseta lämpötila 20–40 °C alhaisemmaksi kuin toiminnolle Ylä + alalämpö.
 Ylä + alalämpö	Kypsentäminen ja paistaminen yhdellä tasolla.
 SteamBake	Kosteuden lisääminen paistamisen aikana. Oikean värin ja rapean pinnan saavuttaminen paistamisen aikana. Mehukkuuden lisääminen uudelleen lämmityksen aikana. Hedelmien ja vihannesten säilöntään.
 Pizza-toiminto	Pizzan valmistaminen. Voimakkaaseen ruskistamiseen ja rapean pohjan luomiseen.
 Alalämpö	Kakkujen paistamiseksi rapealla pohjalla ja ruoan säilömiseksi.
 Pakasteet	Puolivalmisteruokien (esim. ranskalaisten perunoiden, lohkoperunoiden, kevätkääryleiden) valmistaminen rapeiksi.
 Kosteaa kierroilma	Tämä toiminto säästää energiaa ruoanlaiton aikana. Kun käytät tätä toimintoa, uunin sisälämpötila voi poiketa lämpötila-asetuksesta. Jälkilämpötilaa käytetään. Kuumennusteho voi laskea. Katso lisätietoa luvusta "Päivittäinen käyttö", Huomautus: Kosteaa kierroilma:

Uunitoiminto	Sovellus
 Grilli	Ohuiden ruokien grillaus ja leivän paahtaminen.
 Tehogrillaus	Isokojen, luisten liha- tai lintupaistien paistamiseen yhdessä ritiläasennossa. Gratinointi ja ruskistus.
 Valikko	Siirtyminen valikkoon: Avustava ruoanvalmistus, Puhdistus, Asetukset.

6.3 Huomautus: Kostea kiertoilma

Tämän toiminnon avulla määritettiin energiatehokkuusluokka vastaamaan standardeja EU 65/2014 ja EU 66/2014. Testit standardin EN 60350-1 mukaisesti.

Uunin luukun on oltava kiinni ruoanlaiton aikana, jotta toiminto ei keskeytyisi ja uunin energiatehokkuus olisi mahdollisimman suuri.







Kun valitset tämän toiminnon, lamppu sammuu automaattisesti 30 sekunnin kuluttua.

Ruoanlaitto-ohjeet löytyvät luvusta ”Neuvoja ja vinkkejä”, Kosteä kiertoilma. Yleissuosituksia energiansäästämiseksi on luvussa ”Energiatehokkuus”.

6.4 Asetukset: Avustava ruoanvalmistus

Tämän alavalikon kaikki ruokalajit sisältävät toiminto- ja lämpötilasuosituksen. Voit säätää aikaa ja lämpötilaa kypsennyksen yhteydessä.

Joidenkin ruokalajien kohdalla voit valita myös seuraavaa:	Ruoan kypsyytaso:
<ul style="list-style-type: none"> Paistolämpömittari 	<ul style="list-style-type: none"> Puoliraaka Keskitaso Kypsä





Avustava ruoanvalmistus – käytä sitä ruokalajin nopeaan valmistukseen oletusasetuksilla:			
1. vaihe	2. vaihe	3. vaihe	4. vaihe
 	 	 1 - 45	 OK

Avustava ruoanvalmistus – käytä sitä ruokalajin nopeaan valmistukseen oletusasetuksilla:







Siirry valikkoon.	Valitse Avustava ruoanvalmistus. Paina OK.	Valitse ruokalaji. Paina OK.	Laita ruokalaji uuniin. Vahvista asetus.
-------------------	--	------------------------------	--







6.5 Avustava ruoanvalmistus sisältää reseptejä

Symbolien selitys











	Paistolämpömittari saatavana. Aseta Paistolämpömittari paksuimpaan kohtaan. Kun asetettu Paistolämpömittari -osan lämpötila on saavutettu, uuni kytkeytyy automaattisesti pois päältä.
	Höyrytoiminnon edellyttämä vesimäärä.
	Esikuumenna uuni ennen ruokien asettamista uuniin.
	Hyllytaso.





















Kun toiminto päättyy, tarkista, onko ruoka valmis.

	Ruoka-annos	Paino	Hyllytaso / Lisävaruste	Ajallinen kesto
Naudanliha 				
P1	Paahtopaisti, raaka	1–1,5 kg; 4–5 cm paksuudeltaan olevia kappaleita	  2; paistopelti Paista lihaa muutama minuutti kuumalla paistinpannalla. Aseta uuniin.	~ 40 min
P2	Paahtopaisti, puolikypsä			~ 50 min
P3	Paahtopaisti, kypsä			~ 60 min
P4	Pihvi, puolikypsä	180–220 g per kappale; siivut 3 cm paksuudeltaan	   3; paistettava ruoka paistoritilällä Paista lihaa muutama minuutti kuumalla paistinpannalla. Aseta uuniin.	~ 15 min























	Ruoka-annos	Paino	Hyllytaso / Lisävaruste	Ajallinen kesto
P5	Naudanliha-paisti / haudutettu (ensiluokkainen kylki-paisti, paras pyöreä, paksu kylki)	1,5–2 kg	 2; paistettava ruoka paistoritilälä Paista lihaa muutama minuutti kuumalla paistinpannulla. Lisää nestettä. Aseta uuniin.	~ 120 min
P6	Paahtopaisti, raaka (hidas kypsennys)	1–1,5 kg; 4–5 cm paksuudeltaan olevia kappaleita	 2; paistopelti Ota käyttöön suosikkireseptesi tai käytä pelkästään suolaa ja juuri hienonnettua pippuria. Paista lihaa muutama minuutti kuumalla paistinpannulla. Aseta uuniin.	~ 75 min
P7	Paahtopaisti, puolikypsä (hidas kypsennys)			~ 85 min
P8	Paahtopaisti, kypsä (hidas kypsennys)			~ 130 min
P9	Filee, raaka (hidas kypsennys)	0,5–1,5 kg; 5–6 cm paksuudeltaan olevia kappaleita	 2; paistopelti Ota käyttöön suosikkireseptesi tai käytä pelkästään suolaa ja juuri hienonnettua pippuria. Paista lihaa muutama minuutti kuumalla paistinpannulla. Aseta uuniin.	~ 75 min
P10	Filee, puolikypsä (hidas kypsennys)			~ 90 min
P11	Filee, kypsä (hidas kypsennys)			~ 120 min
Vasikanliha 				
P12	Vasikanliha-paahtopaisti (esim. lapa)	0,8–1,5 kg; 4 cm paksuudeltaan olevia kappaleita	 2; paistettava ruoka paistoritilälä Käytä suosikkimausteitasi. Lisää nestettä. Paisti peitetty.	~ 80 min
Porsaanliha 				















PÄIVITTÄINEN KÄYTTÖ

	Ruoka-annos	Paino	Hyllytaso / Lisävaruste	Ajallinen kesto
P13	Porsaanpaisti, niska tai lapa	1,5–2 kg	 2; paistettava ruoka on paistoritilällä Käännä liha kypsennyksen puolivälissä.	~ 120 min
P14	Nyhtöporsaanliha LTC	1,5–2 kg	 2; paistopelti Käytä suosikkimausteitasi. Käännä liha, kun noin puolet kypsennysajasta on kulunut, jotta ruskistus olisi tasainen.	~ 215 min
P15	Kylki, tuore	1–1,5 kg; 5–6 cm paksuudeltaan olevia kappaleita	 2; paistettava ruoka on paistoritilällä Käytä suosikkimausteitasi.	~ 55 min
P16	Siankylki	2–3 kg; käytä raakana, 2–3 cm ohuita kylkipaloja	 3; syvä pannu Lisää nestettä peittämään astian pohjan. Käännä liha kypsennyksen puolivälissä.	90 min
Lampaanliha 				
P17	Lampaankoipuluineen	1,5–2 kg; 7–9 cm paksuudeltaan olevia kappaleita	 2; paistoastia paistopellillä Lisää nestettä. Käännä liha kypsennyksen puolivälissä.	~ 130 min
Linnunliha 				
P18	Kana, kokonainen	1–1,5 kg; tuore	 2;  200 ml; pataruoka-astia paistolevyllä Käytä suosikkimausteitasi. Käännä kana, kun noin puolet kypsennysajasta on kulunut, jotta ruskistus olisi tasainen.	~ 60 min
P19	Kana, puolikas	0,5–0,8 kg	 3; paistopelti Käytä suosikkimausteitasi.	~ 40 min

	Ruoka-annos	Paino	Hyllytaso / Lisävaruste	Ajallinen kesto
P20	Kanan rintafilee	180–200 g per kappale	  2; pataruoka-astia paistoritilällä Käytä suosikkimausteitasi. Paista lihaa muutama minuutti kuumalla paistinpannulla.	~ 25 min
P21	Kanan koivet, tuoreet	-	  3; paistopelti Jos olet ensin marinoidut kanankoivet, aseta matalampi lämpötila ja kypsennä pidempään.	~ 30 min
P22	Kokonainen anka	2–3 kg	  2; paistettava ruoka paistoritilällä Käytä suosikkimausteitasi. Aseta liha paistoastiaan. Käännä anka kypsennyksen puolivälissä.	~ 100 min
P23	Kokonainen hanhi	4–5 kg	  2; syvä pannu Käytä suosikkimausteitasi. Aseta liha syvälle paistopellille. Käännä hanhi kypsennyksen puolivälissä.	~ 110 min
Muu 				
P24	Lihamureke	1 kg	  2; paistoritilä Käytä suosikkimausteitasi.	~ 60 min
 Kala				
P25	Kokonainen kala, grillattu	0,5–1 kg per kala	  2; paistopelti Täytä kala voilla ja ota käyttöön suosikkimausteisi.	~ 30 min
P26	Kalafilee	-	  3; pataruoka-astia paistoritilällä Käytä suosikkimausteitasi.	20 min
Leivonnaiset ja jälkiruokat   				
P27	Juustokakku	-	 2;  28 cm joustomuotti paistoritilällä	90 min





PÄIVITTÄINEN KÄYTTÖ

	Ruoka-annos	Paino	Hyllytaso / Lisävaruste	Ajallinen kesto
P28	Omenakakku	-	 2;  100–150 ml; leivinpelti	60 min
P29	Omenatorttu	-	 2; piirakkamuotti paistoritilällä	40 min
P30	Omenapiirakka	-	 2;  100–150 ml;  22 cm piirakkamuotti paistoritilällä	60 min
P31	Brownie	2 kg	 3; syvä pannu	30 min
P32	Suklaamuffinit	-	 2;  100–150 ml; muffinipelti paistoritilällä	30 min
P33	Murekekakku	-	 2; murekepannu paistoritilällä	50 min
Vihannesannokset/lisukkeet   				
P34	Paistetut perunat	1 kg	 2; leivinpelti Laita kokonaiset kuorelliset perunat paistopellille.	50 min
P35	Lohkoperunat	1 kg	 3; paistopelti katettu leivinpaperilla Käytä suosikkimausteitasi. Leikkaa perunat lohkoiksi.	35 min
P36	Grillatut seka-vihannekset	1–1,5 kg	 3; paistopelti katettu leivinpaperilla Käytä suosikkimausteitasi. Leikkaa vihannekset paloiksi.	30 min
P37	Kuorukat, pakaste	0,5 kg	 3; paistopelti	25 min
P38	Omenat, pakaste	0,75 kg	 3; leivinpelti	25 min
Gratiinit, leipä ja pizza   				
P39	Lasagne / Nuudeli -vuokaruoka	1–1,5 kg	 2; nuudeliannos paistoritilällä	45 min



	Ruoka-annos	Paino	Hyllytaso / Lisävaruste	Ajallinen kesto
P40	Perunapais-tos	1–1,5 kg	 1; nuudeliannos paistoritilällä	50 min
P41	Pizza tuore, ohut	-	  2;  100 ml; paistopelti leivinpaperilla katettu	15 min
P42	Pizza tuore, paksu	-	  2;  100 ml; paistopelti leivinpaperilla katettu	25 min
P43	Piirakka	-	 2; paistovuoka paistoritilällä	45 min
P44	Patonki / Ciabatta / Vaalea leipä	0,8 kg	  3;  150 ml; paistopelti leivinpaperilla katettu Vaalea leipä vaatii enemmän aikaa.	30 min
P45	Kokojyvä / Ruis / Tumma leipä kokojyväleipää limppupannulla	1 kg	  2;  150 ml; leivinpelti leivinpaperilla katettu / paistoritilällä	45 min







7. KELLOTOIMINNOT







7.1 Kellotoiminnot

Kellotoiminto	Sovellus
	Hälytinajastin. Kun ajastin saavuttaa loppupisteen, laitteesta kuuluu äänimerkki.
	Kypsentämisaika. Kun ajastin saavuttaa loppupisteen, laitteesta kuuluu äänimerkki ja uunitoiminto pysähtyy.
	Ajastin. Kypsennyksen käynnistymisen ja/tai päättymisen siirtäminen tuonemmaksi.
	Ajastin. Enintään 23 tuntia 59 minuttia. Tällä toiminnolla ei ole mitään vaikutusta uunin toimintaan. Voit kääntää toiminnon Ajastin päälle ja pois päältä valitsemalla: Valikko, Asetukset.

7.2 Asetukset: Kellotoiminnot

Asetukset: Kellonaika		
1. vaihe	2. vaihe	3. vaihe
		
Jos haluat vaihtaa kellonajan, siirry valikkoon ja valitse Asetukset, Kellonaika.	Aseta kellonaika.	Paina: OK:

Asetukset: Hälytinajastin			
1. vaihe	Näytössä näkyy: 0:00 	2. vaihe	3. vaihe
			
Paina: 		Aseta Hälytinajastin	Paina: OK:
 Ajastin käynnistyy välittömästi.			

Asetukset: Kypsentämisaika				
1. vaihe	2. vaihe	Näytössä näkyy: 0:00  STOP	3. vaihe	4. vaihe
				
Valitse uunitoiminto ja aseta lämpötila.	Paina toistuvasti: 		Kypsennysaika on asetettu.	Paina: OK:
 Ajastin käynnistyy välittömästi.				

KÄYTTÖOHJEET: LISÄVARUSTEET

Asetukset: Ajastin							
1. vaihe	2. vaihe		3. vaihe	4. vaihe		5. vaihe	6. vaihe
		Näytösä näkyy kellonaika 			Näytösä näkyy: --:--  PY-SÄYTÄ		
Valitse uunitoiminto.	Paina toistuvasti: 	KÄYNNISTÄ	Aseta käynnistysaika.	Paina: OK:		Aseta pysäytysaika.	Paina: OK:
 Ajastin aloittaa ajanlaskennan asetettuna käynnistysaikana.							

8. KÄYTTÖOHJEET: LISÄVARUSTEET

8.1 Lisävarusteiden asennus

Pieni lovi yläosassa parantaa turvallisuutta. Lovet estävät myös kallistumisen. Ritilän yläreuna estää keittoastioiden luisumisen kannatintasolta.

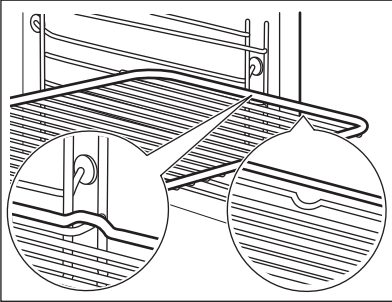
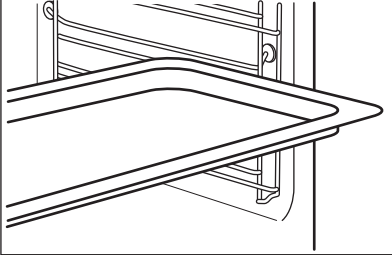
<p>Paistoritilä: Paina ritilä liukukiskojen väliin kannattimeen.</p>	
<p>Leivinpelti /Syvä pannu: Työnnä pelti haluamasi ohjauskiskojen väliin.</p>	

Paistoritilä, Leivinpelti /Syvä pannu:

Paina leivinpelti kannatinkiskon ohjauksiskojeiden väliin ja paistoritilä yläpuolella oleviin ohjauksiskoikiin.

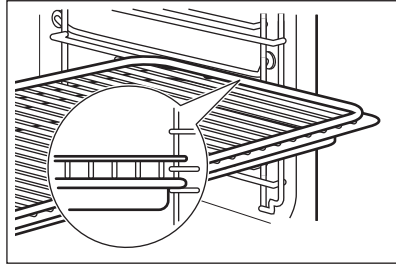

8.2 Paistolämpömittari

Paistolämpömittari – mittaa ruoan sisälämpötilan.

Asetettavia lämpötiloja on kaksi:

°C
Uunin lämpötila.

Sisälämpötila.

Näin saavutat parhaan kypsennystuloksen



Ainesosien pitäisi olla huoneenlämpöisiä.

Älä käytä nestemäisten ruokien suhteen.

Mittari on jätettävä ruokaan kypsennyksen ajaksi.

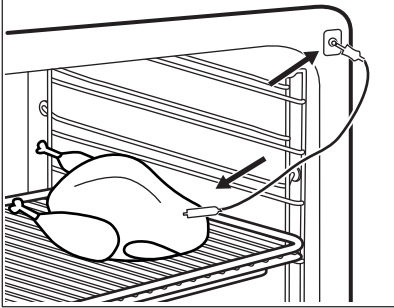
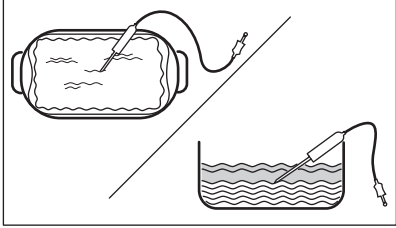

Käyttöohje: Paistolämpömittari

1. vaihe	Kytke uuni päälle.
2. vaihe	Valitse uunitoiminto ja tarvittaessa uunin lämpötila.
3. vaihe	Lisää: Paistolämpömittari:
Liha-, lintu- ja kalaruoka	Vuokaruoka
Aseta Paistolämpömittari kärki lihan tai kalan keskelle paksuimpaan kohtaan, jos mahdollista. Varmista, että vähintään 3/4 Paistolämpömittari on ruoan sisällä.	Aseta Paistolämpömittari kärki tarkalleen vuokaruonan keskelle. Paistolämpömittari tulee asettaa vakaasti paikalleen yhteen kohtaan kypsennyksen ajaksi. Käytä sen vakauttamiseen kiinteää ruoka-ainesta. Käytä paistoastian reunaa tukemaan Paistolämpömittari silikonista valmistettua kädensijaa. Paistolämpömittari -kärki ei saa koskettaa paistoastian pohjaa.

	
<p>4. vaihe</p>	<p>Liitä Paistolämpömittari laitteen etukehyksessä olevaan pistorasiaan. Senhetkinen lämpötila näkyy näytössä: Paistolämpömittari:</p>
<p>5. vaihe</p>	<p> - aseta paistolämpömittarin lämpötila painamalla.</p>
<p>6. vaihe</p>	<p>OK – paina vahvistaaksesi. Kun ruoka on kuumentunut asetettuun lämpötilaan, laitteesta kuuluu äänimerkki. Voit halutessasi lopettaa kypsennyksen tai jatkaa sitä ruoan oikean kypsyyden varmistamiseksi.</p>
<p>7. vaihe</p>	<p>Irrota Paistolämpömittari pistoke pistorasiasta ja poista ruoka uunista.</p> <div style="border: 1px solid black; padding: 5px; margin-top: 10px;"> <p> VAROITUS! Palovammojen vaara on olemassa, sillä Paistolämpömittari kuumentuu erittäin kuumaksi. Ole varovainen pistokkeen irrottamisen ja mittarin poistamisen aikana.</p> </div>

9. LISÄTOIMINNOT

9.1 Lukko



<p>Tämä toiminto estää kuumennustoiminnon tahattoman muuttamisen.</p>		
<p>Kytke se päälle uunin ollessa toiminnassa – valittu ruoanlaitto jatkuu ja ohjauspaneeli on lukittu. Kytke se päälle uunin ollessa pois päältä – uunia ei voi nyt kytkeä päälle, ohjauspaneeli on lukittu.</p>		
	<p>Kytke toiminto päälle painamalla painiketta  OK. Äänimerkki kuuluu.</p>	<p> OK – paina ja pidä painettuna kytkeäksesi sen pois päältä.</p>

Tämä toiminto estää kuumennustoiminnon tahattoman muuttamisen.

① 3 x  – vilkkuu, kun lukko kytketään päälle.

9.2 Automaattinen virrankatkaisu

Turvallisuussyistä uuni kytkeytyy pois päältä jonkin ajan kuluttua, jos jokin uunitoiminto on käynnissä eikä asetuksiin tehdä muutoksia.

 (°C)	 (tunti)
30 - 115	12.5
120 - 195	8.5
200 - 245	5.5
250 – enintään	3

Automaattinen virrankatkaisu ei toimi seuraavien toimintojen kanssa: Uunivalo, Paistolämpömittari, Ajastin.

9.3 Jäähdytyspuhallin

Kun uuni on toiminnassa, jäähdytyspuhallin kytkeytyy automaattisesti toimintaan uunin pintojen pitämiseksi viileinä. Kun kytket uunin pois toiminnasta, jäähdytyspuhallin toimii edelleen, kunnes uuni on jäähtynyt.

9.4 Mekaanin luukun lukko

Luukun lukitus on auki uunin ostaessasi.

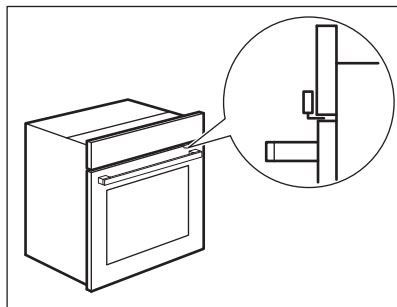

<p>⚠ HUOMIO! Älä siirrä luukun lukkoa pystysuunnassa. Älä työnnä luukun lukkoa uunin luukkua sulkiessasi.</p>	
--	--

9.5 Käyttöohje: Mekaanin luukun lukko

<p>1. vaihe</p>	<p>Lukitse lukku vetämällä luukun lukitusta eteenpäin, kunnes se lukkiutuu.</p>
<p>2. vaihe</p>	<p>Avaa luukku painamalla luukun lukitus takaisin paneeliin.</p>



Lukitun luukun avaaminen

<p>Luukku voidaan avata, kun luukun lukitus on päällä.</p>	
<p>1. vaihe</p>	<p>Paina luukun lukitusta kevyesti ja avaa luukku vetämällä sitä kahvasta.</p>
<p>Varmista luukkua sulkiessasi, että luukun lukitus pysyy kiinni.</p>	

10. VIHJEITÄ JA NEUVOJA



10.1 Kosteaa kiertoilmaa

Noudata alla olevan taulukon ehdotuksia parhaan tuloksen saavuttamiseksi. Käytä kolmatta kannatintasoa.

	 (°C)	 (min)
Pastagratiini	200 - 220	45 - 55
Perunapaistos	180 - 200	70 - 85
Moussaka	170 - 190	70 - 95
Lasagne	180 - 200	75 - 90
Cannelloni	180 - 200	70 - 85
Leipävanukas	190 - 200	55 - 70
Riisivanukas	170 - 190	45 - 60
Omenakakku vatkatusta taikinasta (pyöreä kakkuvuoka)	160 - 170	70 - 80
Vaalea leipä	190 - 200	55 - 70

10.2 Kosteaa kiertoilmaa - suositellut varusteet







Käytä tummia heijastamattomia vuokia ja astioita. Ne absorboivat enemmän lämpöä vaaleisiin ja heijastaviin astioihin verrattuna.







			
Pizzapanu	Uunivuoka	Annosvuokat	Tortturuoka
Tumma, heijastamaton halkaisija 28 cm	Tumma, heijastamaton halkaisija 26 cm	Keraaminen halkaisija 8 cm, korkeus 5 cm	Tumma, heijastamaton halkaisija 28 cm

10.3 Testilaitosten ruoanvalmistustaulukot

Tietoja testilaitokselle

Testit seuraavan mukaisesti: EN 60350, IEC 60350.





 PAISTAMINEN YHDELLÄ KANNATINTASOLLA. Vuossa paistetut leivonnaiset				
		 (°C)	 (min)	
Rasvaton sokerikakku	Kiertoilma	140 - 150	35 - 50	2
Rasvaton sokerikakku	Ylä + alalämpö	160	35 - 50	2
Omenapiirakka, 2 vuokaa Ø20 cm	Kiertoilma	160	60 - 90	2
Omenapiirakka, 2 vuokaa Ø20 cm	Ylä + alalämpö	180	70 - 90	1

 PAISTAMINEN YHDELLÄ KANNATINTASOLLA. Pikkuleiväät				
 Käytä kolmatta kannatintasoa.				
		 (°C)	 (min)	
Murokeksit / Pasteijat	Kiertoilma	140	25 - 40	
Murokeksit / Pasteijat, esikuumenna tyhjä uuni	Ylä + alalämpö	160	20 - 30	
Pienet kakut (20 kpl/leivinpelti), esikuumenna tyhjä uuni	Kiertoilma	150	20 - 35	
Pienet kakut (20 kpl/leivinpelti), esikuumenna tyhjä uuni	Ylä + alalämpö	170	20 - 30	

HOITO JA PUHDISTUS



PAISTAMINEN USEILLA KANNATINTASOILLA. Pikkuleivät

		 (°C)	 (min)	
Murokeksit / Pasteijat	Kiertoilma	140	25 - 45	1 / 4
Pienet kakut (20 kpl/ leivinpelti), esikumenna tyhjä uuni	Kiertoilma	150	23 - 40	1 / 4
Rasvaton sokerikakku	Kiertoilma	160	35 - 50	1 / 4







GRILLI



Esikumenna tyhjää uunia 5 minuutin ajan.



Grillaa lämpötilan maksimiasetuksella.

		 (min)	
Paahtoleipä	Grilli	1 - 3	5
Naudanlihapihvi, käännä kyp- sennyksen puolivälissä	Grilli	24 - 30	4



11. HOITO JA PUHDISTUS



VAROITUS!

Lue turvallisuutta koskevat luvut.

11.1 Puhdistukseen liittyviä huomautuksia

 <p>Puhdistusai- neet</p>	<p>Puhdista uunin etupinnat lämpimällä vedellä ja miedolla pesuaineella käyttäen pehmeää puhdistusliinaa.</p>
	<p>Käytä puhdistusainetta metallipintojen puhdistamiseen.</p>
	<p>Poista tahrat miedolla pesuaineella. Älä käytä sitä katalyyttisiin pintoihin.</p>
 <p>Jokapäiväi- nen käyttö</p>	<p>Puhdista uunin sisäosa jokaisen käytön jälkeen. Rasvan tai muiden roiskeiden kertyminen voi johtaa tulipaloon.</p>
	<p>Älä jätä ruokia uuniin 20 minuuttia pitemmäksi ajaksi. Kuivaa sisäosa pehmeällä liinalla jokaisen käyttökerran jälkeen.</p>
 <p>Lisävarusteet</p>	<p>Puhdista kaikki lisävarusteet käytön jälkeen ja anna niiden kuivua. Käytä pehmeää liinaa, lämmintä vettä ja mietoja puhdistusainetta. Lisävarusteita ei saa pestä astianpesukoneessa.</p>
	<p>Tarttumattomia lisävarusteita ei saa puhdistaa hankaavilla puhdistusaineilla tai teräväreunaisilla esineillä.</p>

11.2 Puhdistaminen: Lokeron reliefi

Poista kalkkijäämät puhdistamalla sisätilan reliefi höyrytoiminnon käyttämisen jälkeen.

1. vaihe	2. vaihe	3. vaihe
<p>Kaada 250 ml valkoviinietikkaa lokeroon. Käytä enintään 6 % viinietikkaa ilman lisäaineita.</p>	<p>Anna viinietikan liuottaa kalkkijäämiä ympäröivässä lämpötilassa 30 minuutin ajan.</p>	<p>Puhdista uunitila pehmeällä liinalla.</p>
<p>Toimintoa varten: SteamBake puhdista uuni aina 5–10 käyttökerran jälkeen.</p>		

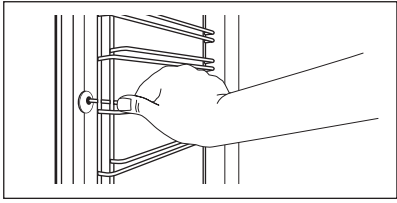
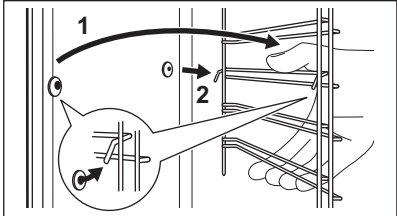

11.3 Irrottaminen: Kannattimet

Poista kannattimet uunin puhdistamiseksi.

1. vaihe	Kytke uuni pois toiminnasta ja odota, että se jäähtyy.	
2. vaihe	Vedä uunipeltien kannattimen etuosa irti sivuseinästä.	
3. vaihe	Vedä kannattimen takaosa irti seinästä ja poista se.	
4. vaihe	Kiinnitä kannattimet takaisin paikalleen suorittamalla toimenpiteet päinvastaisessa järjestyksessä.	

11.4 Käyttöohje: Katalyysipuhdistus

Sisäosassa on katalyyttinen emalipinnoite. Se imee rasvan katalyysipuhdistuksen aikana. Katalyyttisen pinnoitteen tahrat tai värimuutokset eivät vaikuta puhdistukseen.

Puhdista uuni katalyysipuhdistuksella		
Poista kaikki lisävarusteet ennen katalyyttisen puhdistamisen aloittamista.		
1. vaihe	2. vaihe	3. vaihe
Valitse Valikko  / Puhdistus  ja paina OK.	Laitteesta kuuluu äänimerkki, kun puhdistus on päättynyt. Uuni kytkeytyy pois päältä.	Kun uuni on kylmä, puhdistusta sen sisäosa pehmeällä liinalla.
Kesto: 1 tunti.		

11.5 Irrrottaminen ja asentaminen: Luukku

Voit poistaa luukun ja sisäiset lasilevyt niiden puhdistamiseksi. Lasipaneelien lukumäärä vaihtelee eri malleissa.

	VAROITUS! Luukku on painava.
--	--

	HUOMIO! Käsittele lasia varoen, tämä koskee erityisesti etupaneelin reunoja. Lasi voi rikkoutua.
--	--

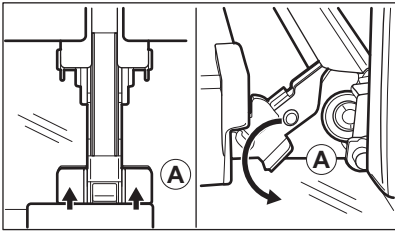
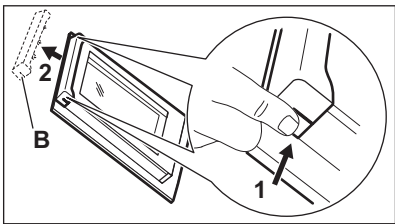
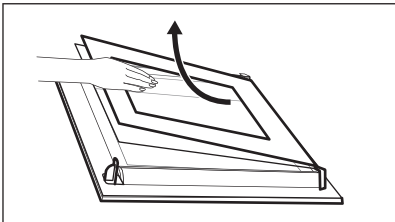
1. vaihe	Avaa luukku kokonaan.	
2. vaihe	Paina ja nosta saranoissa olevat lukitusvivut (A).	
3. vaihe	Sulje uunin luukku ensimmäiseen avausasentoon (likimäärin 70° kulma). Tartu luukkuun kummaltakin puolelta ja vedä se irti uunista ylöspäin suuntautuvassa kulmassa. Aseta luukku sen ulkopinta alaspäin vakaalle pinnalle levitetyn liinan päälle.	
4. vaihe	Pidä kiinni luukun reunalistasta (B) molemmin puolin luukun yläreunaa ja työnnä sisäänpäin vapauttaaksesi pinnetiivisteet.	
5. vaihe	Irrota luukun reunalista vetämällä sitä eteenpäin.	
6. vaihe	Tartu lasilevyihin yläreunasta ja vedä ne yksi kerrallaan ulos sivulla olevista kiskoista.	
7. vaihe	Puhdista lasipaneeli vedellä ja saippualla. Kuivaa lasipaneeli huolellisesti. Lasilevyjä ei saa pestä astianpesukoneessa.	
8. vaihe	Suorita edellä kuvatut vaiheet päinvastaisessa järjestyksessä puhdistamisen jälkeen.	
9. vaihe	Kiinnitä ensiksi pienin lasilevy, sitten suurempi ja lopuksi luukku. Varmista, että lasit on asetettu oikeaan asentoon. Muutoin luukun pinta voi ylikuumentua.	

11.6 Vaihtaminen: Lamppu



VAROITUS!

Sähköiskun vaara.
Lamppu voi olla kuuma.

VIANMÄÄRITYS

Ennen lampun vaihtamista:

1. vaihe	2. vaihe	3. vaihe
Kytke uuni pois päältä. Odota, kunnes uuni on jäähtynyt.	Irrota uunin pistoke pistorasiasta.	Peitä uunin pohja kankaalla.

Ylälamppu

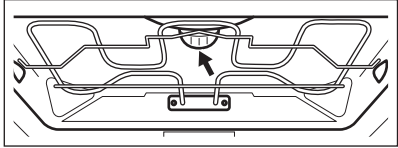
1. vaihe	Irrota suojalasi kiertämällä sitä.	
2. vaihe	Puhdista suojalasi.	
3. vaihe	Vaihda lamppu sopivaan 300 °C lämmönkestävään lamppuun.	
4. vaihe	Kiinnitä suojalasi paikalleen.	

Sivulamppu

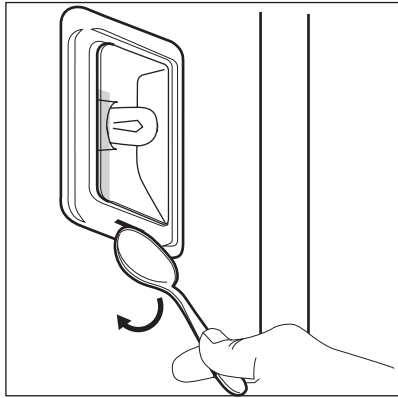
1. vaihe	Poista vasen kannatin päästäksesi lamppuun.	
2. vaihe	Irrota suojalasi kapealla ja tylpällä esineellä (esim. teelusikalla).	
3. vaihe	Puhdista suojalasi.	
4. vaihe	Vaihda lamppu sopivaan 300 °C lämmönkestävään lamppuun.	
5. vaihe	Kiinnitä suojalasi paikalleen.	
6. vaihe	Asenna vasen kannatin.	

12. VIANMÄÄRITYS





VAROITUS!

Lue turvallisuutta koskevat luvut.

12.1 Käyttöhäiriöt...

Mikäli laitteessa ilmenevää ongelmaa ei ole kuvattu tässä taulukossa, ota yhteyttä valtuutettuun huoltoliikkeeseen.

 Uuni ei käynnisty tai ei kuumene	
Ongelma	Tarkista, jos...
Uuni ei kytkeydy päälle eikä sitä voi käyttää.	Uuni on yhdistetty asianmukaisesti sähköverkkoon.
Uuni ei kuumene.	Automaattinen virrankatkaisu on pois toiminnasta.
Uuni ei kuumene.	Sulake ei ole palanut.
Uuni ei kuumene.	Lapsilukko on kytketty pois toiminnasta.

 Komponentit	
Ongelma	Tarkista, jos...
Lamppu on kytketty pois päältä.	Kostea kiertoilma – on kytketty päälle.
Lamppu ei toimi.	Lamppu on palanut.
Paistolämpömittari ei toimi.	Paistolämpömittari -osan pistoke on liitetty asianmukaisesti pistokkeeseen.

 Virhekoodit	
Näytössä näkyvä...	Tarkista, jos...
Err C2	Osan Paistolämpömittari pistoke on irrotettu pistorasiasta.
00:00	On tapahtunut virtakatko. Aseta kellonaika.
<p>Jos näytössä näkyy jokin muu kuin tässä taulukossa kuvattu virhekoodi, kytke asuinrakennuksen sulake pois päältä ja uudelleen päälle ja käynnistä sitten uuni uudelleen. Jos virhekoodi tulee uudelleen näkyviin, ota yhteyttä valtuutettuun huoltopalveluun.</p>	

ENERGIATEHOKKUUS



Puhdistus

Ongelma	Tarkista, jos...
Vettä vuotaa uunin lokerosta.	Lokerossa on liikaa vettä.

12.2 Huoltotiedot

Jos ratkaisua ei löydy, ota yhteys jälleenmyyjään taivaltuutettuun huoltopalveluun. Huoltopalvelun vaatimat tiedot on merkitty arvokilpeen. Arvokilpi sijaitsee uunin sisäosan etukehyksessä. Älä poista arvokilpeä uunista.

Suosittelemme, että kirjoita tiedot tähän:	
Malli (MOD.)
Tuotenumero (PNC)
Sarjanumero (S.N.)

13. ENERGIATEHOKKUUS

13.1 Tuotetiedot ja tuotteen tietolomake*

Tavarantoimittajan nimi	Electrolux
Mallin tunnus	COC826X 944032024
Energialuokka	81,2
Energiatehokkuusluokka	A+
Energiankulutus normaalikäytössä Ylä- ja alalämpö -toiminnoissa	1,09 kWh/ohjelma
Energiankulutus normaalikäytössä Kiertoilma-toiminnossa	0,69 kWh/ohjelma
Pesien lukumäärä	1
Lämpölähde	Sähkö

Tilavuus	71 l
Uunityyppi	Kalusteeseen asennettava uuni
Massa	33.0 kg

* Euroopan unionissa EU-määräyksien 65/2014 ja 66/2014 mukaisesti.
Valko-Venäjän tasavallassa STB 2478-2017:n liitteen G ja STB 2477-2017:n liitteiden A ja B mukaisesti.
Ukrainassa määräyksen 568/32020 mukaisesti.

Energiatehokkuusluokka ei koske Venäjää.

EN 60350-1 - Ruoanlaittoon tarkoitettut sähkötoimiset kodinkoneet - Osa 1: Tuotesarjat, uunit, höyryuunit ja grillit - Suorituskyvyn mittaustavat.

13.2 Energiansäästö



Uunissa on toimintoja, joiden avulla voit säästää energiaa päivittäisessä ruoanlaitossa.

Varmista, että uunin luukku on kiinni uunin ollessa toiminnassa. Älä avaa luukkuja liian usein kypsennyksen aikana. Pidä luukun tiiviste puhtaana ja varmista, että se on hyvin kiinni paikoillaan.

Käytä metallisia keittoastioita energiatehokkuuden parantamiseksi.

Kun mahdollista, älä esikuumenna uunia ennen ruokien asettamista uuniin.

Minimoi paistojen väliset tauot, kun valmistat kerralla useampia ruokia.

Puhallintoiminnon käyttäminen ruoanlaiton yhteydessä

Jos mahdollista, käytä uunitoimintoja puhaltimella energian säästämiseksi.

Jäännöslämpö

Puhaltimen ja lampun toiminta jatkuu. Kun sammutat uunin, näytössä näkyy jälkilämpö.

Lämmön avulla voit pitää ruoka-aineksia lämpimänä.

Kun kypsennys kestää yli 30 minuuttia, laske uunin lämpötilaa vähintään 3–10 minuuttia ennen kypsennysajan päättymistä. Jälkilämpö uunissa jatkaa ruoka-aineksien kypsentämistä.

Lämmitä muita ruokalajeja jälkilämpöä käyttäen.

Ruoan lämpimänä pitoon

Valitse alhaisin mahdollisin lämpötila-asetus, niin voit hyödyntää jälkilämmön ja säilyttää aterian lämpimänä. Jälkilämmön merkivalo tai lämpötila syttyy näyttöön.

Kypsentäminen lampun ollessa sammutettuna

Kytke lamppu pois päältä kypsennyksen aikana. Kytke se päälle ainoastaan tarvittaessa.



Kosteaa kiertoilmaa



Tämä toiminto säästää energiaa ruoanlaiton aikana.







Kun tämä toiminto on käytössä, lamppu sammuu automaattisesti 30 sekunnin kuluttua. Voit sytyttää lampun uudelleen, mutta tällöin energiasäästö on pienempi.

14. VALIKKORAKENNE

14.1 Valikko

	 – valitse, jotta voit siirtyä kohteeseen Valikko.
---	---

Valikko rakenne		
Avustava ruoanvalmistus 	Puhdistus 	Asetukset 

1. vaihe	2. vaihe	3. vaihe	4. vaihe	5. vaihe
 	 OK	 O1 - O14	 OK	
Valitse Valikko, Asetukset.	Vahvista asetus.	Valitse asetus.	Vahvista asetus.	Säädä arvoa ja paina OK.

Asetukset					
O1	Kellonaika	Muuta	O2	Näytön kirkkaus	1 - 5
O3	Painikeäänet	1 – Ääni- merkki 2 – Paini- keäänet 3 – Ääni pois päältä	O4	Äänenvoimakkuus	1 - 4
O5	Paistolämpömittari Toi- menpide	1 – Hälytys ja pysäytys 2 – Hälytys	O6	Ajastin	Päälle/Pois päältä
O7	Uunivalo	Päälle/Pois päältä	O8	Pikakuumennus	Päälle/Pois päältä
O9	Wi-Fi-yhteys	Päälle/Pois päältä	O10	Automaattinen kau- ko-ohjaus	Päälle/Pois päältä

Asetukset					
O11	Unohda verkko	Kyllä / Ei	O12	Demo-toiminto	Aktivointikoodi: 2468
O13	Ohjelmistoversio	Tarkista	O14	Palauta tehdasasetukset	Kyllä / Ei

15. YMPÄRISTÖNSUOJELU

Kierrätä materiaalit, jotka on merkitty merkillä . Kierrätä pakkaus laittamalla se asianmukaiseen kierrätysastiaan. Suojele ympäristöä ja ihmisten terveyttä kierrättämällä sähkö- ja elektroniikkaromut. Älä hävitä merkillä  merkittyjä kodinkoneita kotitalousjätteen mukana. Palauta tuote paikalliseen kierrätyskeskukseen tai ota yhteyttä paikalliseen viranomaiseen.

VI TENKER PÅ DEG

Takk for at du har kjøpt et produkt fra Electrolux. Du har valgt et produkt som bringer flere tiår med erfaring og innovasjon med seg. Genialt og stilig, og det er designet med tanke på deg. Så uansett når du bruker det, kan du være trygg på at du får gode resultater hver gang. Velkommen til Electrolux.

Gå inn på nettsiden vår for å:



Få råd om bruk, brosjyrer, hjelp til feilsøking, og informasjon om service og reparasjon:
www.electrolux.com/support



Registrer produktet for å få bedre service:
www.registerelectrolux.com



Kjøp tilbehør, forbruksvarer og originale reservedeler til apparatet ditt:
www.electrolux.com/shop



For flere oppskrifter, tips, feilsøking last ned **My Electrolux Kitchen** appen.



KUNDESTØTTE OG SERVICE

Bruk alltid originale reservedeler.

Når du kontakter vårt autoriserte servicesenter, må du sørge for at du har følgende opplysninger tilgjengelig: Modell, PNC, serienummer.

Informasjonen finner du på typeskiltet.

 Advarsel/Forsiktig – Sikkerhetsinformasjon

 Generell informasjon og tips

 Miljøinformasjon

Med forbehold om endringer.

INNHold

1. SIKKERHETSINFORMASJON.....	122	3. PRODUKTBEKRIVELSE.....	126
1.1 Sikkerhet for barn og sårbare mennesker.....	122	3.1 Generell oversikt.....	127
1.2 Generell sikkerhet.....	122	3.2 Tilbehør.....	127
2. SIKKERHETSANVISNINGER.....	123	4. SLIK SLÅR DU OVNE PÅ OG AV.....	128
2.1 Montering.....	123	4.1 Skjult lås.....	128
2.2 Elektrisk tilkobling.....	124	4.2 Betjeningspanel.....	128
2.3 Bruk.....	125	5. FØR FØRSTE GANGS BRUK.....	130
2.4 Stell og rengjøring.....	126	5.1 Første gangs rengjøring.....	130
2.5 Innvendig lys.....	126	5.2 Første gangs forvarming.....	130
2.6 Service.....	126	5.3 Trådløs tilkobling 	130
2.7 Kasting.....	126	5.4 Programvarelisenser.....	131

6. DAGLIG BRUK.....	131	10.2 Baking med fukt –	147
6.1		anbefalt tilbehør.....	147
Slik stiller du inn: Varmefunksjoner....	132	10.3 Tilberedningstabeller for	
6.2 Varmefunksjoner.....	132	testinstitutter.....	147
6.3 Merknader om: Baking med fukt..	134	11. STELL OG RENGJØRING.....	149
6.4 Slik stiller du inn:		11.1 Merknader om rengjøring.....	150
Assistert matlaging.....	134	11.2 Slik rengjør du: Gravert	
6.5 Assistert matlaging		ovnsrom.....	150
med oppskrifter.....	135	11.3 Slik fjerner du: Hyllestøtter.....	150
7. KLOKKEFUNKSJONER.....	140	11.4 Slik bruker du: Katalytisk	
7.1 Klokkefunksjonene.....	140	rengjøring	151
7.2		11.5	
Slik stiller du inn: Klokkefunksjonene.	140	Slik fjerner du og installerer: Dør.....	151
8. BRUK: PRAKTISK TILBEHØR.....	141	11.6 Slik bytter du: Ovnslampe.....	152
8.1 Innsetting av tilbehør.....	142	12. FEILSØKING.....	153
8.2 Steketermometer.....	142	12.1 Hva må gjøres, hvis.....	154
9. TILLEGGSFUNKSJONER.....	144	12.2 Servicedata.....	155
9.1 Sperre.....	144	13. ENERGIEFFEKTIV.....	155
9.2 Automatisk utkopling.....	144	13.1 Produktinformasjon og	
9.3 Kjølevifte.....	145	produktinformasjonsark*.....	155
9.4 Mekanisk dørlås.....	145	13.2 Energisparing.....	156
9.5 Slik bruker du: Mekanisk dørlås... 145		14. MENYSTRUKTUR.....	156
10. RÅD OG TIPS.....	146	14.1 Meny.....	157
10.1 Baking med fukt.....	146		

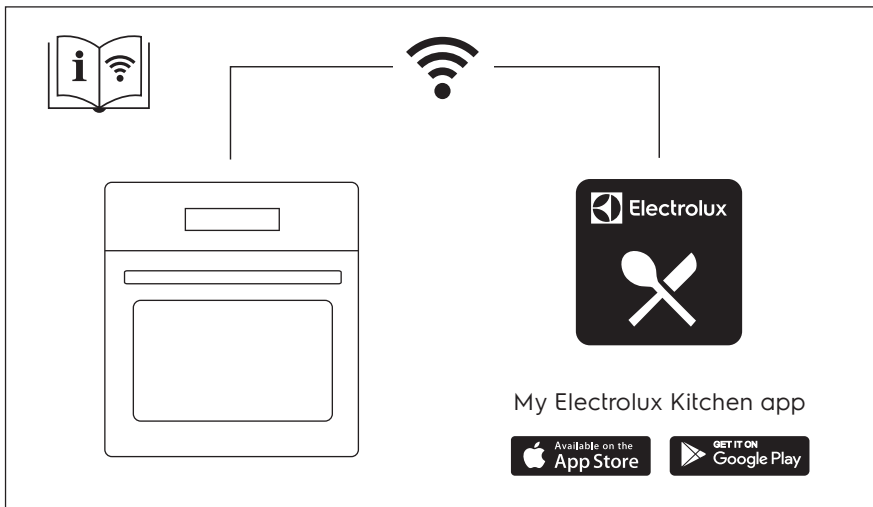

1. ⚠️ SIKKERHETSINFORMASJON

Les medfølgende instruksjoner nøye innen du installerer og bruker apparatet. Produsenten er ikke ansvarlig for personskader eller andre skader som følge av feilaktig montering eller bruk. Hold alltid instruksjonene på et trygt og tilgjengelig sted for fremtidig referanse.

1.1 Sikkerhet for barn og sårbare mennesker

- Dette produktet kan brukes av barn fra 8 år og oppover og personer med reduserte fysiske, sensoriske eller mentale evner eller manglende erfaring og kunnskap, dersom de får tilsyn eller instruksjoner om bruken av produktet på en sikker måte, og forstår farene som er involvert. Barn under 8 år og personer med svært omfattende og komplekse funksjonsnedsettelse må holdes på avstand fra produktet med mindre de er under tilsyn til enhver tid.
- Barn bør være under oppsyn for å sikre at de ikke leker med apparatet og mobile enheter med My Electrolux Kitchen.
- Oppbevar all emballasje utilgjengelig for barn og kast den på riktig måte.
- ADVARSEL: Hold barn og kjæledyr borte fra produktet når det er i bruk eller når det avkjøles. Tilgjengelige deler blir varme under bruk.
- Hvis produktet har en barnesikring, bør den aktiveres.
- Rengjøring og vedlikehold av produktet skal ikke utføres av barn.

1.2 Generell sikkerhet

- Bare en kvalifisert person må montere produktet og skifte ut kablet.
- Bruk ikke produktet før du installerer det i en innebygget enhet.
- Trekk støpselet ut av stikkontakten før du utfører vedlikehold.

- Om stikkontakten er skadet må den erstattes av produsenten, et autorisert servicesenter eller tilsvarende kvalifiserte personer for å unngå elektriske fare.
- **ADVARSEL:** Sørg for at apparatet er slått av før du bytter lampen for å unngå fare for elektrisk støt.
- **ADVARSEL:** Apparatet og tilgjengelige deler blir varme under bruk. Pass på at du ikke berører varmeelementene.
- Bruk alltid grillvotter når du tar ut eller putter inn tilbehør eller ovnsutstyr.
- Bruk kun matsensoren (steketermometeret) som anbefales for dette apparatet.
- For å fjerne hyllestøttene, må du først trekk fronten på hyllestøtten og baksiden på hyllestøtten vekk fra sideveggene. Bruk omvendt rekkefølge for å montere ovnsstigene.
- Ikke bruk damprengjøring til å rengjøre apparatet.
- Ikke bruk skurende rengjøringsmidler eller skarpe skrapegjenstander av metall for å rengjøre dørglasset i stekeovnen, da dette kan ripe opp glasset og føre til at glasset blir matt.

2. SIKKERHETSANVISNINGER

2.1 Montering

**ADVARSEL!**

Bare en kvalifisert person må montere dette produktet.

- Fjern all emballasje.
- Ikke monter eller bruk et skadet produkt.
- Følg installasjonsanvisningene som følger med produktet.
- Vær alltid forsiktig når du flytter produktet. Det er tungt. Bruk alltid vernebriller og lukket føttøy.
- Ikke dra eller løft produktet etter håndtaket.
- Monter produktet på et trygt og egnet sted som oppfyller monteringskrav.
- Overhold minimumsavstanden fra andre produkter og enheter.
- Før du monterer produktet, sjekk at ovnsdøren åpner uten hindring.
- Produktet er utstyrt med et elektrisk kjølesystem. Det må brukes med elektrisk strømforsyning.
- Innbyggingsenheten må møte kravene til stabilitet i DIN 68930.

SIKKERHETSANVISNINGER

Minstehøyde for skap (minstehøyde for skap under benkeplate)	578 (600) mm
Skapbredde	560 mm
Skapdybde	550 (550) mm
Høyden av fronten av apparatet	594 mm
Høyden av baksiden av apparatet	576 mm
Bredden av fronten av apparatet	595 mm
Bredden av baksiden av apparatet	559 mm
Dybden av apparatet	567 mm
Apparatets innebygde dybde	546 mm
Dybde med døren åpen	1027 mm
Minsteåpning for ventilasjon. Åpning er plassert på nedre bakside	560 x 20 mm
Lengden på strømledningen. Strømledningen finner du i høyre hjørne på baksiden	1500 mm
Monteringsskruer	4 x 25 mm

2.2 Elektrisk tilkobling



ADVARSEL!

Fare for brann og elektrisk støt.

- Alle elektriske tilkoblinger skal utføres av en kvalifisert elektriker.
- Produktet må være jordet.
- Kontroller at parametere på typeskiltet er kompatible med de elektriske spesifikasjonene i strømforsyningen.
- Bruk alltid en korrekt montert, jordet stikkontakt.
- Ikke bruk grenuttak eller skjøteledninger.
- Pass på at støpselet og strømkabelen ikke påføres skade. Hvis strømkabelen må erstattes, må dette utføres av vårt Autoriserte servicesenter.
- Strømkablene må ikke berøre eller komme nær apparatets dør eller sprekken under apparatet, spesielt ikke når den er i bruk eller når døren er varm.
- Beskyttelsen mot elektrisk støt fra strømførende og isolerte deler må festes på en måte som gjør at den ikke kan fjernes uten verktøy.

- Ikke sett støpselet i stikkkontakten før monteringen er fullført. Påse at det er tilgang til stikkkontakten etter monteringen.
- Hvis stikkkontakten er løs skal du ikke sette i støpselet.
- Ikke trekk i kabelen for å koble fra produktet. Trekk alltid i selve støpselet.
- Bruk kun korrekte isoleringsenheter: vernebrytere, sikringer (sikringer av skrutypen fjernet fra holderen), jordfeilbrytere og kontaktorer.
- Den elektriske monteringen må ha en isoleringsenhet som lar deg frakoble apparatet fra strømmettet ved alle poler. Isoleringsenheten må ha en kontaktåpningsbredde på minst 3 mm.
- Apparatet leveres med støpsel og strømledning.

2.3 Bruk



ADVARSEL!

Risiko for skade, brannskader og elektrisk støt eller eksplosjon.

- Dette apparatet er kun for husholdningsbruk (innendørs).
- Produktets spesifikasjoner må ikke endres.
- Pass på at ventilasjonsåpningene ikke er blokkerte.
- Ikke la produktet være uten tilsyn mens det er i drift.
- Slå av apparatet etter hver bruk.
- Vær forsiktig når du åpner døren til apparatet når apparatet er i bruk. Varmluft kan slippe ut.
- Ikke bruk produktet med våte hender eller når det er i kontakt med vann.
- Ikke belast døren når den er åpen.
- Bruk ikke apparatet som arbeids- eller oppbevaringsflate.
- Åpne døren til produktet forsiktig. Bruk av ingredienser med alkohol kan føre til en blanding av alkohol og luft.
- Ikke la gnister eller åpne flammer komme i kontakt med apparatet når du åpner døren.
- Legg ikke brennbare produkter, eller gjenstander som er fuktet med brennbare produkter, inn i eller i nærheten av apparatet.
- Ikke del Wi-Fi-passordet ditt.



ADVARSEL!

Fare for skade på produktet.

- For å forhindre skade på emaljen:
 - ikke plasser ovnsutstyr eller andre gjenstander direkte i bunnen av apparatet.
 - ikke legg aluminiumsfolie direkte på bunnen av rommet i apparatet.
 - ikke tøm vann direkte inn i det varme apparatet.
 - ikke oppbevar fuktig servise eller mat i apparatet når tilberedningen er ferdig.
 - vær forsiktig når du fjerner eller monterer tilbehøret.
- Misfarge på apparatets emalje eller rustfritt stål har ingen innvirkning på funksjonen.
- Bruk en grill-/stekepanne for bløte kaker. Fruktsaft gir permanente flekker.
- Dette apparatet skal kun brukes til matlaging. Den må ikke brukes til andre formål, for eksempel oppvarming av rom.
- Ha alltid ovnsdøren lukket når stekeovnsdøren er lukket.
- Hvis produktet er montert bak et møbelpanel (f.eks. en dør), må du sørge for at døren aldri er lukket når produktet er i drift. Varme og fuktighet kan bygge seg opp bak et lukket møbelpanel og dermed forårsake skade på apparatet, boligen eller gulvet. Ikke lukk møbelpanelet før apparatet er helt avkjølt etter bruk.

2.4 Stell og rengjøring



ADVARSEL!

Risiko for skade, brann eller skade på produktet.

- Slå av apparatet og trekk støpselet ut av stikkkontakten før rengjøring og vedlikehold.
- Påse at produktet er kaldt. Det er fare for at glasspanelene kan knuses.
- Erstatt umiddelbart panelene til glassdørene om disse har blitt skadet. Kontakt det autoriserte servicesenteret.
- Vær forsiktig når du fjerner døren fra produktet. Døren er tung!
- Rengjør apparatet med jevne mellomrom for å forhindre skade på overflaten.
- Rengjør apparatet med en fuktet myk klut. Bruk kun nøytralt vaskemiddel. Bruk ikke slipeprodukter, slipende rengjøringsputer, løsemidler eller metallobjekter.
- Følg sikkerhetsanvisningene på pakken hvis du bruker ovnsspray.
- Ikke rengjør den katalytiske emaljen med vaskemidler.

2.5 Innvendig lys



ADVARSEL!

Fare for elektrisk støt.

- Angående lampen(e) i dette produktet og reservedeler som selges separat: Disse lampene er ment å motstå ekstreme fysiske forhold i husholdningsprodukter, for eksempel temperatur, vibrasjon, fuktighet, eller er ment å signalisere informasjon om produktets driftsstatus. De er ikke ment å brukes i andre bruksområder og egner seg ikke til rombelysning.
- Bruk kun lyspærer med tilsvarende spesifikasjoner.

2.6 Service

- Kontakt det autoriserte servicesenteret for å reparere apparatet.
- Det skal bare brukes originale reservedeler.

2.7 Kasting



ADVARSEL!

Fare for skade og kvelning.

- Koble produktet fra strømmen.
- Kutt av strømkabelen, lukk produktet og kast den.
- Fjern dørlåsen for å forhindre at barn, eller kjæledyr kan bli innestengt i apparatet.

3. PRODUKTBEKRIVELSE

3.1 Generell oversikt

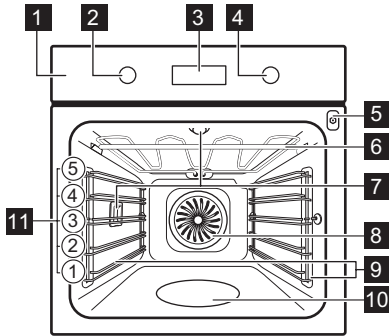

- 1** Betjeningspanel
- 2** Bryter for ovnsfunksjoner
- 3** Display
- 4** Betjeningsbryter
- 5** Kontakt til steketermometer
- 6** Varmeelement
- 7** Lys
- 8** Vifte
- 9** Uttakbare brettstiger
- 10** Gravert ovnsrom
- 11** Hyllnivåer

3.2 Tilbehør

Rist

For kokekar, kakeformer, steker.

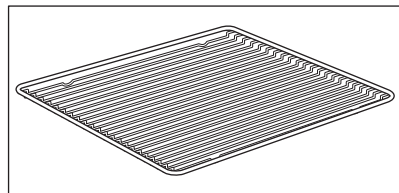

SLIK SLÅR DU OVNEN PÅ OG AV

Stekebrett

For kaker og kjeks.

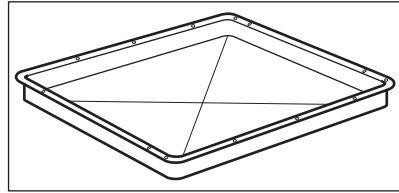

Grill-/stekepanne

For å bake eller steke eller for å samle opp fett.

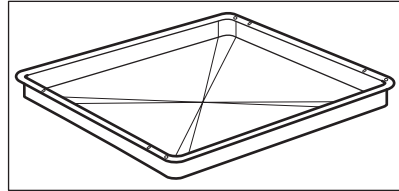

Proffbrett

For rundstykker, saltstenger og småkaker. Egnet for dampfunksjoner. Misfarging av overflaten har ingen effekt på funksjonaliteten.

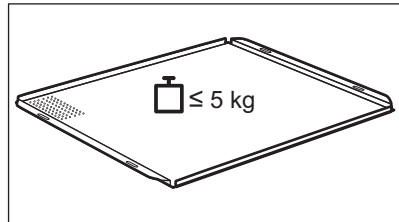

Steketermometer

Måler temperaturen i maten.

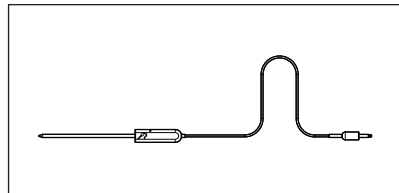







4. SLIK SLÅR DU OVNEN PÅ OG AV

4.1 Skjult lås



For å bruke produktet, trykker du på bryteren. Bryteren kommer ut.









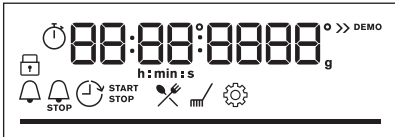

4.2 Betjeningspanel

Sensorfelt for betjeningspanel					Trykk på	Drei bryteren
 Timer	 Hurtigoppvarming	 Lys	 Steketermometer	OK		

SLIK SLÅR DU OVNEEN PÅ OG AV



Sensorfelt for betjeningspanel	Trykk på	Drei bryteren
Velg en ovnsfunksjon for å slå på ovnen.		
Vri bryteren for ovnsfunksjonen til av-posisjonen for å slå av ovnen.		

	Når bryteren for ovnsfunksjonene er av, går displayet til standby.
	Når du lager mat viser displayet den angitte temperaturen, tid på dagen og andre tilgjengelige tilvalg.
	Displayet med maks antall funksjoner er valgt.

Displayindikatorer				
 Sperre	 Assistert matlagning	 Rengjøring	 Oppsett	 Hurtigoppvarming
Timer-indikatorer:				
Wi-Fi-indikator – blinker når ovnen kan kobles til Wi-Fi.			Fjernstyring-indikator – ovnen kan fjernstyres.	
 Wi-Fi-tilkoblingen er slått på.			 Fjernstyring er slått på.	

Fremdriftslinje – for temperatur eller tid.	
--	---





FØR FØRSTE GANGS BRUK

Indikator for matlaging med damp	
Steketermometer indikator	





5. FØR FØRSTE GANGS BRUK

 ADVARSEL! Se etter i Sikkerhetskapitlene.
--

5.1 Første gangs rengjøring

Rengjør tom stekeovn og angi tiden før første gangs bruk:			
			 00:00 Still inn tiden. Trykk på OK.

5.2 Første gangs forvarming

 Forvarm den tomme ovnen før første gangs bruk.	
Steg 1	Ta ut alt tilbehør og avtakbare brettstiger fra ovnen.
Steg 2	Velg maksimumstemperaturen for funksjonen:  . La ovnen stå på i 1 time.
Steg 3	Velg maksimumstemperaturen for funksjonen:  . La ovnen stå på i 15 minutter.
 Ovnens kan avgi lukt og røyk under forvarming. Sørg for tilstrekkelig ventilasjon i rommet.	

5.3 Trådløs tilkobling

For å koble til ovnen trenger du:

- Trådløst nettverk med internettilkobling.
- Mobil enhet koblet til det trådløse nettverket.

Steg 1	Last ned mobilappen My Electrolux Kitchen og følg instruksjonene for de neste stegene.
Steg 2	Drei bryteren for å velge:  .

Frekvens	2,4 GHz WLAN	5 GHz WLAN
	2400–2483,5 MHz	5150–5350 MHz 5470–5725 MHz
Protokoll	IEEE 802.11 b DSSS, 802.11 g/n OFDM	IEEE 802.11 a/n OFDM
Maks effekt	EIRP < 20 dBm (100 mW)	EIRP < 23 dBm (200 mW)
Wi-Fi-modul	NIU5-50	

Bluetooth-frekvens	2400–2483,5 Mhz
Protokoll	LE: DSSS
Maks effekt	EIRP < 4 dBm (2.5 mW)

EU-medlemstater som dekkes av bestemmelsen i direktiv 2014/53/EU: Belgia, Bulgaria, Tsjekkia, Danmark, Tyskland, Estland, Irland, Hellas, Spania, Frankrike, Kroatia, Italia, Kypros, Latvia, Litauen, Luxemburg, Ungarn, Malta, Nederland, Østerrike, Polen, Portugal, Romania, Slovenia, Slovakia, Finland, Sverige, Norge, Sveits, Storbritannia, Tyrkia.

5.4 Programvarelisenser

Programvaren i dette produktet inneholder komponenter som er basert på programvarer fra gratis og åpne kilder. Electrolux erkjenner tydelig bidrag fra åpne programvare og robotsamfunn til utviklingsprosjektet.

Gå frem på følgende måte for å få tilgang til kildekoden til disse programvarene fra gratis og åpne komponenter med lisensvilkår som krever publisering, og for å se hele informasjonen om opphavsrett og gjeldende lisensvilkår, gå til: <http://electrolux.opensoftwarerepository.com> (mappe NIU5).



6. DAGLIG BRUK





ADVARSEL!

Se etter i Sikkerhetskapitlene.

6.1 Slik stiller du inn: Varmefunksjoner









Start tilberedningen	
Steg 1	Steg 2
	
Still inn en ovnsfunksjon.	Still inn temperaturen.

Matlaging med damp			
Kontroller at ovnen er kald.			
Steg 1	Steg 2	Steg 3	Steg 4
			Forvarm den tomme ovnen i 10 min. for å danne fuktighet. Legg maten i ovnen.
Fyll hulrommet med vann fra springen.	Angi ovnsfunksjonen med damp.	Still inn temperaturen.	
ⓘ Hulrommet har maksimal kapasitet på 250 ml. Fyll ikke hulrommet på nytt under matlaging eller når ovnen er varm.			

Når dampkokingen avslutter:		
Steg 1	Steg 2	Steg 3
Vri bryteren for ovnsfunksjonene til av-posisjonen for å slå av ovnen.	Åpne døren forsiktig. Frigitt fuktighet kan forårsake brannskader.	Kontroller at ovnen er kald. Fjern gjenværende vann fra ovnsrommet.

6.2 Varmefunksjoner

Standard ovnsfunksjoner

Ovnsfunksjon	Anvendelse
 Ekte Varmluft	Slik baker du på opptil tre hyllnivåer samtidig og tørker mat. Angi temperaturen 20–40 °C lavere enn Over- og undervarme.
 Over- og undervarme	For å bake og steke på én brett plassering.
 SteamBake	For å tilføre fuktighet under tilberedningen. For å få riktig farge og sprø skorpe under baking. For å gjenoppvarme mat med saftigere resultater. Hermetisering av frukt eller grønnsaker.
 Pizzafunksjon	Slik steker du pizza. For å oppnå en mer intens brunning og sprø bunn.
 Undervarme	For å hermetisere mat og bake kaker med sprø bunn.
 Frossen mat	For å gjøre halvfabrikata og hurtigmat (f.eks. pommefrites, potetbåter og vårruller) sprøere.
 Baking med fukt	Denne funksjonen er laget med tanke på å spare energi når man lager mat. Når du bruker denne funksjonen, kan temperaturen i ovnsrommet variere fra den angitte temperaturen. Restvarmen brukes. Varmeeffekten kan reduseres. For mer informasjon, se kapittelet «Daglig bruk», merknader om: Baking med fukt.
 Grill	Slik griller du tynne matstykker og rister brød.
 Gratinerings med vifte	For å steke store kjøttstykker eller fjærfe på én brett plassering. For å gratinere og brune.

Ovnfunksjon	Anvendelse
 Meny	For å gå inn i Menyene: Assistert matlaging, Rengjøring, Oppsett.

6.3 Merknader om: Baking med fukt

Denne funksjonen blir brukt til å overholde energieffektivitetsklassen og økologiske designkrav i henhold til EU 65/2014 og EU 66/2014. Tester i henhold til EN 60350-1.

Stekeovnsdøren bør være lukket under tilberedning slik at funksjonen ikke forstyrres, og ovnen er i drift med høyest mulig energieffektivitet.







Når du bruker denne funksjonen, slås ovnslampen automatisk av etter 30 sekunder.

For matlaginginstruksjonene, se kapittelet «Råd og tips», Baking med fukt. Se kapittelet «Energieffektivitet» for generelle anbefalinger for energisparing.





6.4 Slik stiller du inn: Assistert matlaging

Hver rett i denne undermenyen har en anbefalt funksjon og temperatur. Du kan justere tiden og temperaturen under matlagingen.









For enkelte av rettene kan du også lage mat med:	Tilberedningsgrad:
<ul style="list-style-type: none"> • Steketermometer 	<ul style="list-style-type: none"> • Rå • Medium – rosa • Godt stekt







Assistert matlaging – bruk den til å tilberede en rett raskt med standardinnstillinger:			
Steg 1	Steg 2	Steg 3	Steg 4
 	 	 1 - 45	 OK
Gå inn i menyene.	Velg Assistert matlaging. Trykk OK.	Velg retten. Trykk på OK.	Sett retten inn i ovnen. Bekreft innstilling.



















6.5 Assistert matlaging med oppskrifter























Bildetekst	
	Steketermometer tilgjengelig. Plasser Steketermometer i den tykkeste delen av retten. Stekeovnen slår seg av når den innstilte Steketermometer temperatur er nådd.
	Vannmengden til dampfunksjonen.
	Forvarm ovnen før du begynner matlagingen.
	Bretthøyde.

















Når funksjonen er ferdig, kontroller at maten er klar.

	Rett	Vekt	Bretthøyde / tilbehør	Tid for steketid
Storfekjøtt 				
P1	Roastbiff, rå	1–1,5 kg; 4–5 cm tykke stykker	  2; stekebrett Stek kjøttet i et par minutter i en varm panne. Sett inn i ovnen.	~ 40 min
P2	Roastbiff, medium			~ 50 min
P3	Roastbiff, godt stekt			~ 60 min
P4	Biff, medium	180–220 g per stykke; 3 cm tykke skiver	   3; stekeform på rist Stek kjøttet i et par minutter i en varm panne. Sett inn i ovnen.	~ 15 min
P5	Oksestek / brasert (ribbe, rund, tykk flanke)	1,5–2 kg	  2; stekeform på rist Stek kjøttet i et par minutter i en varm panne. Tilsett væske. Sett inn i ovnen.	~ 120 min



	Rett	Vekt	Brethøyde / tilbehør	Tid for steketid
P6	Roastbiff, rå (langtidsste- king)	1–1,5 kg; 4– 5 cm tykke stykker	 2; stekebrett Bruk favorittkrydderet ditt eller bare salt og nykværnet pepper. Stek kjøttet i et par minutter i en varm panne. Sett inn i ov- nen.	~ 75 min
P7	Roastbiff, me- dium (langtids- steking)			~ 85 min
P8	Roastbiff, godt stekt (langtidsste- king)			~ 130 min
P9	Filet, rå (lang- tidssteking)	0,5–1,5 kg; 5–6 cm tyk- ke stykker	 2; stekebrett Bruk favorittkrydderet ditt eller bare salt og nykværnet pepper. Stek kjøttet i et par minutter i en varm panne. Sett inn i ov- nen.	~ 75 min
P10	Filet, middels (langtidsste- king)			~ 90 min
P11	Filet, fullført (langtidsste- king)			~ 120 min
Kalv 				
P12	Kalvestek (f.eks. skulder)	0,8–1,5 kg; 4 cm tykke stykker	 2; stekeform på rist Bruk favorittkrydderet ditt. Tilsett væske. Stek det tildekket.	~ 80 min
Svinekjøtt 				
P13	Svinestek el- ler skulder	1,5–2 kg	 2; stekeform på rist Snu kjøttet etter halve steketiden.	~ 120 min
P14	Pulled pork LTS	1,5–2 kg	 2; stekebrett Bruk favorittkrydderet ditt. Snu kjøttet et- ter halve tilberedningstiden for å få en jevn stekefarge.	~ 215 min

	Rett	Vekt	Brethøyde / tilbehør	Tid for steketid
P15	Fersk filet	1–1,5 kg; 5–6 cm tykke stykker	  2; stekeform på rist Bruk favorittkrydderet ditt.	~ 55 min
P16	Spareribs	2–3 kg; bruk rå, 2–3 cm tynn spare-ribs	 3; langpanne Tilsett væske for å dekke bunnen av en form. Snu kjøttet etter halve steketiden.	90 min
Lammekjøtt 				
P17	Lammelår med ben	1,5–2 kg; 7–9 cm tykke stykker	  2; stekeform på stekebrett Tilsett væske. Snu kjøttet etter halve steketiden.	~ 130 min
Fjærkre 				
P18	Hel kylling	1–1,5 kg; fersk	  2;  200 ml; gryterett på stekebrett Bruk favorittkrydderet ditt. Snu kyllingen etter halve tilberedningstiden for å få en jevn stekefarge.	~ 60 min
P19	Halv kylling	0,5–0,8 kg	  3; stekebrett Bruk favorittkrydderet ditt.	~ 40 min
P20	Kyllingbryst	180–200 g per stykke	  2; gryterett på rist Bruk favorittkrydderet ditt. Stek kjøttet i et par minutter i en varm panne.	~ 25 min
P21	Kyllinglår, ferske	-	  3; stekebrett Hvis du marinerer kyllingbein først, angi lavere temperatur og kok dem lenger.	~ 30 min
P22	Hel and	2–3 kg	  2; stekeform på rist Bruk favorittkrydderet ditt. Legg kjøttet på stekebrett. Snu anden etter halve steketiden.	~ 100 min

	Rett	Vekt	Brethøyde / tilbehør	Tid for steketid
P23	Hel gås	4–5 kg	  2; langpanne Bruk favorittkrydderet ditt. Legg kjøttet på stekebrettet. Snu gåsen etter halve steketiden.	~ 110 min
Andre 				
P24	Kjøttpudding	1 kg	  2; rist Bruk favorittkrydderet ditt.	~ 60 min
 Fisk				
P25	Hel fisk, grillet	0,5–1 kg per fisk	  2; stekebrett Fyll fisken med smør og bruk favorittkrydder og urter.	~ 30 min
P26	Fiskefilet	-	  3; gryterett på rist Bruk favorittkrydderet ditt.	20 min
Søtbakst / desserter   				
P27	Ostekake	-	 2; \emptyset 28 cm rund form rist	90 min
P28	Eplekake	-	 2;  100–150 ml; stekebrett	60 min
P29	Epleterte	-	 2; paiform på rist	40 min
P30	Eplekake	-	 2;  100–150 ml; \emptyset 22 cm paiform på rist	60 min
P31	Brownies	2 kg	 3; langpanne	30 min
P32	Sjokolademuffins	-	 2;  100–150 ml; muffinsbrett på rist	30 min
P33	Brødkake	-	 2; loff-form på rist	50 min





	Rett	Vekt	Brethøyde / tilbehør	Tid for steketid
Grønnsaker / tilbehør 				
P34	Bakte poteter	1 kg	 2; stekebrett Legg hele poteter med skinn rett på stekebrettet.	50 min
P35	Båter	1 kg	 3; stekebrett med bakepapir Bruk favorittkrydderet ditt. Skjær potetene i biter.	35 min
P36	Stekt blandede grønnsaker	1–1,5 kg	 3; stekebrett med bakepapir Bruk favorittkrydderet ditt. Del grønnsakene i stykker.	30 min
P37	Croquettes, frossen	0,5 kg	 3; stekebrett	25 min
P38	Pommes frites, frossen	0,75 kg	 3; stekebrett	25 min
Gratenger, brød og pizza 				
P39	Lasagne / nudelgryte	1–1,5 kg	 2; gryterett på rist	45 min
P40	Potetgrateng	1–1,5 kg	 1; gryterett på rist	50 min
P41	Fersk pizza, tynn	-	  2; 100 ml; stekebrett med bakepapir	15 min
P42	Pizza fersk, tykk	-	  2; 100 ml; stekebrett med bakepapir	25 min
P43	Quiche	-	 2; stekeform på rist	45 min
P44	Baguette / Ciabatta / loff	0,8 kg	  3; 150 ml; stekebrett med bakepapir Det trengs mer tid for loff.	30 min

KLOKKEFUNKSJONER

	Rett	Vekt	Brethøyde / tilbehør	Tid for steketid
P45	Kornet / rugbrød / mørkt brød i brødform	1 kg	  2;  150 ml; stekebrett med bakepapir / rist	45 min







7. KLOKKEFUNKSJONER







7.1 Klokkefunksjonene











Klokkefunksjon	Anvendelse
	Varselur. Når tidtakeren er ferdig, høres et lydsignal.
	Tilberedningstid. Når tidtakeren er ferdig, hører du et lydsignal og ovnsfunksjonen stopper.
	Utsatt tid. For å utsette starten og/eller slutten på matlagingen.
	Tidsinnstilling. Maksimaltid er 23 t 59 min. Denne funksjonen har ingen innvirkning på bruk av ovnen. For å slå av og på Tidsinnstilling velg: Meny, Oppsett.

7.2 Slik stiller du inn: Klokkefunksjonene

Slik angir du: Tid på dagen		
Steg 1	Steg 2	Steg 3
		
For å endre klokkeslett, gå inn i menyen og velg Innstillinger, Klokkeslett.	Still klokken.	Trykk på: OK.

Slik angir du: Varselur			
Steg 1	Displayet viser: 00:00 	Steg 2	Steg 3
			
Trykk på: 		Angi Varselur	Trykk på: OK.
 Timeren starter nedtellingen med det samme.			

Slik angir du: Tilberedningstid				
Steg 1	Steg 2	Displayet viser: 00:00  STOP	Steg 3	Steg 4
				
Velg en ovnsfunksjon og still inn temperaturen.	Trykk gjentatte ganger: 		Still inn tilberedningstiden.	Trykk på: OK.
 Timeren starter nedtellingen med det samme.				

Slik angir du: Utsatt tid							
Steg 1	Steg 2	Displayet viser: tid på dagen  START	Steg 3	Steg 4	Displayet viser: ---:  STOPP	Steg 5	Steg 6
							
Velg ovnsfunksjon.	Trykk gjentatte ganger: 		Angi starttid.	Trykk på: OK.		Angi ferdigtid.	Trykk på: OK.
 Timer startet å telle ned ved innstilt starttid.							

8. BRUK: PRAKTISK TILBEHØR

8.1 Innsetting av tilbehør

Små fordypninger øverst for å øke sikkerheten. Fordypningene hindrer også de i å tippe. Den høye kanten rundt risten forhindrer at kokekar sklir av risten.

Rist:

Sett ristene inn mellom sporene på hyllestøtten .

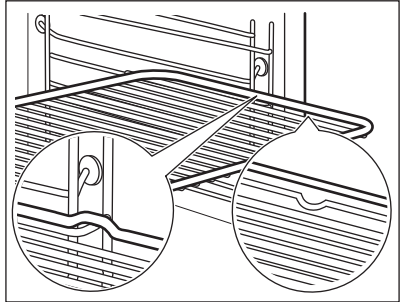

Stekebrett /Langpanne:

Skyv brettet inn i sporene på brettstigene.

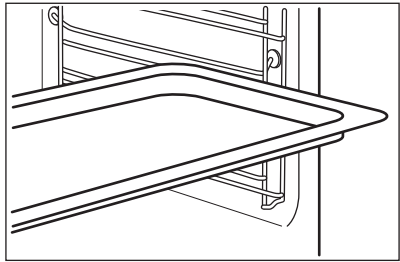

Rist, Stekebrett /Langpanne:

Skyv brettet inn mellom sporene på brettstigen og risten på sporene over.

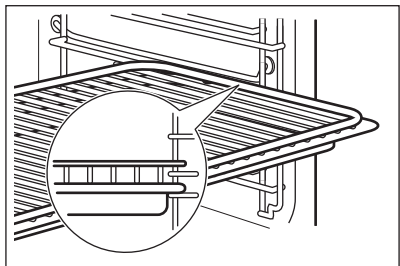

8.2 Steketermometer

Steketermometer- måler temperaturen i maten.

To temperaturer må stilles inn:

°C
Ovnstemperaturen.

Kjernetemperaturen.

Slik får du best tilberedningsresultater:

Ingrediensene bør holde romtemperatur.



Ikke bruk det til flytende retter.

Det må stå i retten under tilberedningen.

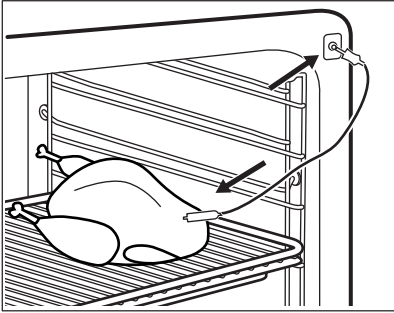
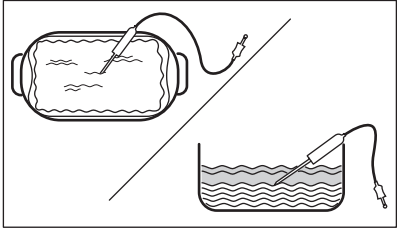
Bruk: Steketermometer







Steg 1	Slå på ovnen.	
Steg 2	Angi varmefunksjon og, om nødvendig, ovnstemperatur.	
Steg 3	Sett inn: Steketermometer.	
Kjøtt, fjærkre og fisk	Gryterett	
<p>Sett spissen på Steketermometer inn i midten av kjøttet eller fisken, helst i den tykkeste delen. Sørg for at minst 3/4 av Steketermometer er inne i retten.</p>	<p>Sett spissen på Steketermometer nøyaktig i midten av gryteretten. Steketermometer bør stå stødig på samme sted under steking. For å oppnå dette kan du bruke en solid ingrediens. Bruk kanten av formen som støtte for silikonhåndtaket på Steketermometer. Tuppen av Steketermometer ikke berører bunnen av formen.</p>	
		
Steg 4	Sett Steketermometer i kontakten på fremsiden av ovnen. Displayet viser den aktuelle temperaturen til: Steketermometer.	

TILLEGGSFUNKSJONER

Steg 5	 – trykk for å angi kjernetemperaturen til sensoren.
Steg 6	OK – trykk for å bekrefte. Når retten når den angitte temperaturen, hører du et lydsignal. Du kan velge å stoppe eller å fortsette tilberedningen for å sikre at maten er godt stekt.
Steg 7	Fjern Steketermometer pluggen fra kontakten og ta retten ut av ovnen. <div style="border: 1px solid black; padding: 5px;"> ADVARSEL! Siden Steketermometer blir svært varm er det en risiko for brannskader. Vær forsiktig når du trekker ut pluggen på sensoren og fjerner den fra maten.</div>



9. TILLEGGSFUNKSJONER

9.1 Sperre

Denne funksjonen forhindrer at ovnsfunksjonen endres ved et uhell.		
Slå den på når ovnen er på – den innstilte tilberedningen fortsetter og betjeningspanelet er låst. Slå den på når ovnen er av – ovnen kan ikke slås på og betjeningspanelet er låst.		
 	 OK – trykk og hold for å slå på funksjonen. Det høres et lydsignal.	 OK – trykk og hold inne for å slå den av.
 3 x  – blinker når låsen er slått på.		

9.2 Automatisk utkopling

Av sikkerhetsmessige hensyn slår ovnen seg av etter en viss tid dersom en varmefunksjon er i bruk og ingen innstillinger endres.

 (°C)	 (t)
30 - 115	12.5
120 - 195	8.5
200 - 245	5.5



 (°C)	 (t)
250 – maksimum	3

Automatisk utkobling virker ikke med funksjonene: Lys, Steketermometer, Utsatt tid.

9.3 Kjølevifte

Mens ovnen er i bruk, slår kjøleviften seg på automatisk for å holde ovnens overflater kalde. Hvis du slår av ovnen, kan kjøleviften være aktiv til ovnen er kjølt ned.

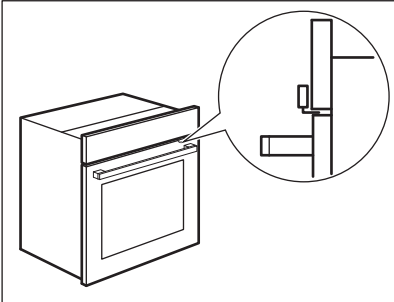
9.4 Mekanisk dørlås

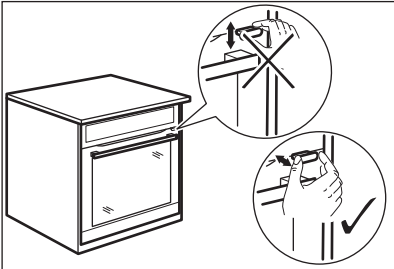
<p>Dørlåsen er ulåst når du kjøper ovnen.</p>	
<p> FORSIKTIG! Ikke flytt dørlåsen vertikalt. Ikke skyv på dørlåsen når du lukker ovnsdøren.</p>	

9.5 Slik bruker du: Mekanisk dørlås

Steg 1	For å låse døren trekker du dørlåsen fremover til den låser seg.
---------------	--

RÅD OG TIPS

Steg 2

For å låse opp døren skyver du dørlåsen tilbake inn i panelet.

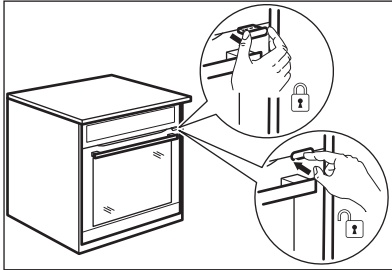

Slik åpner du den låste døren

Du kan åpne døren når dørlåsen er låst.

Steg 1

Skyv litt på dørlåsen og åpne døren ved å trekke i håndtaket.

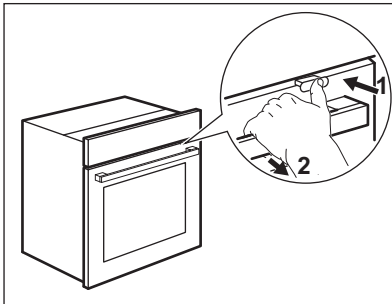







Når du lukker døren, må du påse at dørlåsen forblir låst.

10. RÅD OG TIPS

10.1 Baking med fukt



Følg forslagene i tabellen for best mulig resultater.
Bruk den tredje brett plasseringen.

	 (°C)	 (min)
Pastagrateg	200 - 220	45 - 55
Potetgrateg	180 - 200	70 - 85

	 (°C)	 (min)
Moussaka	170 - 190	70 - 95
Lasagne	180 - 200	75 - 90
Cannelloni	180 - 200	70 - 85
Brøduppuding	190 - 200	55 - 70
Rispudding	170 - 190	45 - 60
Eplekake av formkakedeig (rund kakeform)	160 - 170	70 - 80
Loff	190 - 200	55 - 70

10.2 Baking med fukt – anbefalt tilbehør

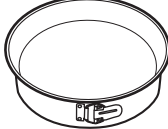
Bruk mørke og ikke-refleksive bokser og beholderen. De har bedre varmeabsorbering enn den lette fargen og de reflekserive rettene.

			
Pizzapanne	Kakeform	Ramekins	Form for karamellpudding
Mørk, ikke-reflekterende 28 cm diameter	Mørk, ikke-reflekterende 26 cm diameter	Keramikk 8 cm diameter, 5 cm høyde	Mørk, ikke-reflekterende 28 cm diameter





10.3 Tilberedningstabeller for testinstitutter

Informasjon for testinstitutter

Tester i henhold til: EN 60350, IEC 60350.



STEKING I ÉN HØYDE. Baking i former





		 (°C)	 (min)	
Fettfritt formkake	Ekte Varmluft	140 – 150	35 – 50	2
Fettfritt formkake	Over- og undervarme	160	35 – 50	2
Eplepai, 2 former Ø 20 cm	Ekte Varmluft	160	60 – 90	2
Eplepai, 2 former Ø 20 cm	Over- og undervarme	180	70 – 90	1



STEKING I ÉN HØYDE. Kjeks



Bruk det tredje hyllenivået.

		 (°C)	 (min)
Kjeks / Deigstriper	Ekte Varmluft	140	25 – 40
Kjeks / Deigstriper, forvarm den tomme ovnen	Over- og undervarme	160	20 – 30
Småkaker, 20 stk. per stekebrett, forvarm den tomme ovnen	Ekte Varmluft	150	20 – 35
Småkaker, 20 stk. per stekebrett, forvarm den tomme ovnen	Over- og undervarme	170	20 – 30

STELL OG RENGJØRING



STEKING I FLERE HØYDER. Kjeks

		 (°C)	 (min)	
Kjeks / Deigstriper	Ekte Varmluft	140	25 – 45	1 / 4
Småkaker, 20 stk. per stekebrett, forvarm den tomme ovnen	Ekte Varmluft	150	23 – 40	1 / 4
Fettfritt formkake	Ekte Varmluft	160	35 – 50	1 / 4



GRILL



Forvarm den tomme ovnen i 5 minutter.



Grill med maksimum temperaturinnstilling.

		 (min)	
Smørbrød	Grill	1 – 3	5
Storfestek, snu halvveis	Grill	24–30	4

11. STELL OG RENGJØRING





ADVARSEL!

Se etter i Sikkerhetskapitlene.

11.1 Merknader om rengjøring

 Rengjøringsmidler	Rengjør ovnens forside med en myk klut med varmt vann og et mildt vaskemiddel.
	Bruk en rengjøringsløsning for å rengjøre metalloverflater.
	Rengjør flekker med et mildt vaskemiddel. Du må ikke bruke den på de katalytiske overflatene.

 Hverdagsbruk	Rengjør ovnsrommet etter bruk. Fettopsamling eller andre rester kan føre til brann.
	Ikke la maten bli stående i ovnen lenger enn 20 minutter. Tørk av ovnsrommet med en myk klut etter bruk.

 Tilbehør	Rengjør alt tilbehør etter hver bruk og la det tørke. Bruk en myk klut med varmt vann og mildt vaskemiddel. Ikke rengjør tilbehøret i oppvaskmaskinen.
	Rengjør ikke tilbehør med slippbelegg med sterke vaskemidler eller skarpe gjenstander.

11.2 Slik rengjør du: Gravert ovnsrom

Rengjør ovnsrommet for å fjerne kalkrester etter damptilberedning.

Steg 1	Steg 2	Steg 3
Hell 250 ml hvit eddik i ovnsrommet. Bruk maks 6 % eddik uten tilsetningsmidler.	La eddiken løse opp kalkrestene i romtemperatur i 30 minutter.	Rengjør ovnsrommet med varmt vann og en myk klut.
For funksjonen: SteamBake rengjør ovnen for hver 5. – 10. kokesyklus.		

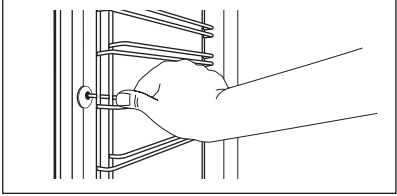
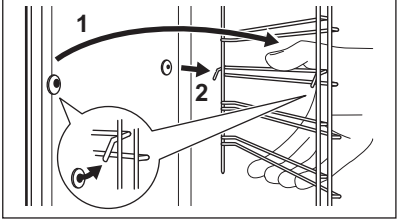

11.3 Slik fjerner du: Hyllestøtter

Fjern brettstigenefor å rengjøre ovnen.

Steg 1	Slå ovnen av, og vent til det er kaldt.	
Steg 2	Trekk den fremre delen av ovnsstigen ut fra sideveggen.	
Steg 3	Trekk den bakre delen av ovnsstigen ut fra veggen og ta dem ut.	
Steg 4	Bruk omvendt rekkefølge for å montere ovnsstigen.	

11.4 Slik bruker du: Katalytisk rengjøring

Ovnsrommet er belagt med en katalytisk emalje. Den absorberer fett under katalyse. Flekker eller misfarging av det katalytiske belegget har ingenting å si for rengjøringen.

Rengjør ovnen med katalytisk rengjøring		
Fjern alt tilbehør før katalytisk rensing.		
Steg 1	Steg 2	Steg 3
Velg Meny  / Rengjøring  og trykk på OK.	Signalet lyder når rengjøringen er ferdig. Ovnen slår seg av.	Tørk over ovnsrommet med en våt og myk klut når den er kald.
Varighet: 1 t.		

11.5 Slik fjerner du og installerer: Dør

Du kan fjerne døren og det indre glasspanelet for å rengjøre det. Antall glass er forskjellig for ulike modeller.



ADVARSEL!
Døren er tung.



FORSIKTIG!
Hånder glasset forsiktig, særlig på kantene på frontpanelet. Glasset kan knuse.

STELL OG RENGJØRING

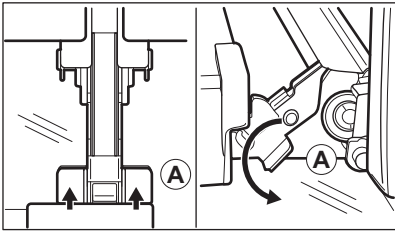
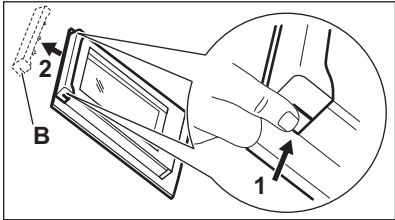
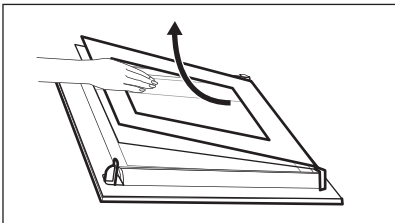
Steg 1	Åpne døren helt.	
Steg 2	Løft og trykk klemmefestene (A) på begge dørhengslene.	
Steg 3	Lukk døren til første åpneposisjon (ved tilnærmet 70° vinkel). Hold ovnsdøren i begge sider og trekk den ut og opp fra ovnen. Legg døren med utsiden ned på et mykt og stabilt underlag.	
Steg 4	Hold dørlisten (B) øverst på døren på begge sider og trykk innover for å frigjøre klipslåsen.	
Steg 5	Trekk dørlisten mot deg for å fjerne den.	
Steg 6	Hold et og et glass øverst i kanten og trekk dem oppover og ut av føringen.	
Steg 7	Rengjør glasspanelet med såpe og vann. Tørk glasspanelet grundig. Ikke rengjør glasspanelene i oppvaskmaskinen.	
Steg 8	Gjenta stegene ovenfor i motsatt rekkefølge etter rengjøring.	
Steg 9	Monter det minste panelet først, så det store, og til slutt døren. Kontroller at glassene er satt inn og ligger i riktig posisjon, ellers kan overflaten på døren overopphetes.	

11.6 Slik bytter du: Ovnslampe



ADVARSEL!

Fare for elektrisk støt.
Lampen kan være varm.

Før du skifter pæren:

Steg 1	Steg 2	Steg 3
Slå av ovnen. Vent til ovnen er avkjølt.	Koble fra strømtilførselen til ovnen.	Legg en klut på bunnen i ovnsrommet.

Øverste ovnslampe

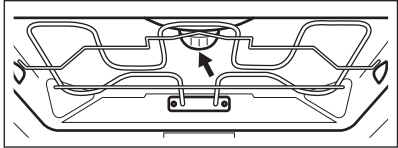
Steg 1	Drei glassdekselet for å ta det av.	
Steg 2	Rengjør lampedekselet.	
Steg 3	Erstatt pæren med en egnet varmebestandig lyspære som tåler 300 °C.	
Steg 4	Monter glassdekselet.	

Sidelys

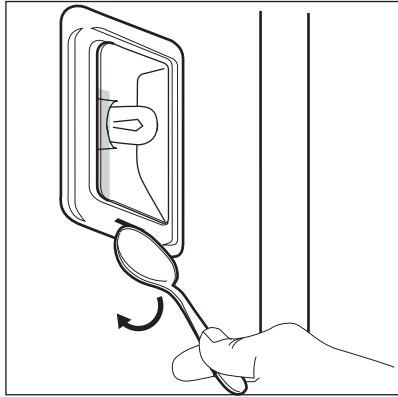
Steg 1	Fjern den venstre brettstigen for å få tilgang til lampen.	
Steg 2	Bruk en smal, butt gjenstand (f.eks. skaftet på en teskje) for å fjerne glassdekselet.	
Steg 3	Rengjør lampedekselet.	
Steg 4	Erstatt pæren med en egnet varmebestandig lyspære som tåler 300 °C.	
Steg 5	Monter glassdekselet.	
Steg 6	Monter den venstre ovnsstigen.	

12. FEILSØKING



ADVARSEL!

Se etter i Sikkerhetskapitlene.

12.1 Hva må gjøres, hvis...

tilfeller som ikke er inkludert i denne tabellen, ta kontakt med et autorisert servicesenter.



Ovnen slår seg ikke på eller blir ikke oppvarmet

Problem	Kontroller at...
Du kan ikke aktivere eller betjene ovnen.	Ovnen er koblet til strømforsyningen på riktig måte.
Ovnen blir ikke varm.	Den automatiske utkoplingsfunksjonen er deaktivert.
Ovnen blir ikke varm.	Sikringen har gått.
Ovnen blir ikke varm.	Barnesikringen er av.



Komponenter

Problem	Kontroller at...
Lampen er slått av.	Baking med fukt – er slått på.
Lampen fungerer ikke.	Lyspæren har gått.
Steketermometer starter ikke.	Pluggen til Steketermometer er satt helt inn i kontakten.



Feilkoder

Displayet viser ...	Kontroller at...
Err C2	Du trakk Steketermometer -støpslet ut av stikkontakten.
00:00	Det var strømbrytning. Angi tid på dagen.

Hvis displayet viser en feilkode som ikke står i denne tabellen, må du slå sikringene i huset av og på for å starte ovnen på nytt. Hvis feilmeldingen vises igjen, ta kontakt med et autorisert servicesenter.

**Rengjøring**

Problem	Kontroller at...
Vannet lekker ut av ovnen.	Det er for mye vann i ovnen.

12.2 Servicedata

Hvis du ikke greier å løse problemet selv, kontakter du forhandleren eller et autorisert servicesenter.

Nødvendig informasjon som servicesenteret trenger, kan du finne på typeskiltet. Typeskiltet er plassert på den fremre rammen til ovnsrommet. Ikke fjern typeskiltet fra ovnsrommet.

Vi anbefaler at du noterer opplysningene her:	
Modell (MOD.)
Produktnummer (PNC)
Serienummer (S.N.)

13. ENERGIEFFEKTIV**13.1 Produktinformasjon og produktinformasjonsark***

Leverandørens navn	Electrolux
Modellidentifikasjon	COC826X 944032024
Energieffektivitetsindeks	81.2
Energieffektivitetsklasse	A+
Energiforbruk med standard matmengde, over- og under-varme	1.09 kWh/syklus
Energiforbruk med standard matmengde, viftetvunget modus	0.69 kWh/syklus
Antall hulrom	1
Varmekilde	Elektrisitet

Volum	71 l
Type ovn	Innebygd ovn
Masse	33.0 kg

* For European Union i henhold til EU-reguleringene 65/2014 og 66/2014.
For Republikken Hviterussland i henhold til STB 2478-2017, vedlegg G; STB 2477-2017, vedlegg A og B.
For Ukraina i henhold til 568/32020.

Energieffektivitetsklasse gjelder ikke for Russland.

EN 60350-1 – Elektriske kjøkkenapparater – Del 1: Typer, ovner, dampovner og griller – metoder for måling av ytelser.

13.2 Energisparing



Ovnen har funksjoner som hjelper deg med å spare strøm under matlaging.

Påse at ovnsdøren er lukket mens ovnen er på. Ikke åpne ovnsdøren for ofte under matlaging. Hold dørpakningen ren og sørg for at den sitter godt på plass.

Bruk kokekar i metall for å øke energisparingen.

Når det er mulig skal du ikke forvarme ovnen før matlaging.

Hold pausene mellom stekingene så kort som mulig når du lager flere retter om gangen.

Matlaging med vifte

Bruk om mulig tilberedningsfunksjoner med vifte for å spare strøm.

Restvarme

Viften og ovnslampen vil fortsette å fungere. Når du slår av ovnen viser skjermen restvarmen. Denne varmen kan du bruke til å holde maten varm.

Når tilberedningstiden er lengre enn 30 min, reduser ovnstemperaturen til minimum 3–10 min før tilberedningen avsluttes. Restvarmen inne i ovnen fortsetter å steke.

Bruk restvarmen til å varme opp andre retter.

Slik holder du maten varm

Hvis du vil bruke restvarmen til å holde måltidet varmt, velg lavest mulig temperaturinnstilling. Displayet viser restvarmeindikatoren eller -temperaturen.

Matlaging med lampen av

Slå av lampen under matlaging. Slå den på kun når du behøver den.

Baking med fukt



Funksjonen er laget med tanke på å spare strøm under matlaging.







Når du bruker denne funksjonen, slås ovnslampen automatisk av etter 30 sek. Du kan slå på ovnslampen igjen, men dette reduserer forventet energibesparing.

14. MENYSTRUKTUR

14.1 Meny



	 – velg for å gå inn i Meny.
---	---

Meny struktur		
Assistert matlaging 	Rengjøring 	Oppsett 

Steg 1	Steg 2	Steg 3	Steg 4	Steg 5
 	 OK	 O1 – O14	 OK	
Velg Meny, Oppsett.	Bekreft innstilling.	Velg innstillingen.	Bekreft innstilling.	Juster verdien og trykk OK.

Oppsett					
O1	Tid på dagen	Endre	O2	Skjermlysstyrke	1 - 5
O3	Tastelyder	1 – Pip 2 – Klikk 3 – Lyd av	O4	Summerlyd	1 - 4
O5	Steketermometer handling	1 – Alarm og stopp 2 – Alarm	O6	Tidsinnstilling	På/av
O7	Lys	På/av	O8	Hurtigoppvarming	På/av
O9	Wi-Fi	På/av	O10	Automatisk fjernbruk	På/av
O11	Glem nettverk	Ja / Nei	O12	Demomodus	Aktiveringskode: 2468
O13	Programvareversjon	Kontroller	O14	Tilbakestill alle innstillinger	Ja / Nei

15. BESKYTTELSE AV MILJØET

Resirkuler materialer som er merket med symbolet . Legg emballasjen i riktige beholdere for å resirkulere det. Bidrar til å beskytte miljøet, menneskers helse og for å resirkulere avfall av elektriske og elektroniske produkter. Ikke kast produkter som er merket med symbolet  sammen med husholdningsavfallet. Produktet kan leveres der hvor tilsvarende produkt selges eller på miljøstasjonen i kommunen. Kontakt kommunen for nærmere opplysninger.

VI TÄNKER PÅ DIG

Tack för att du har köpt en Electrolux-produkt. Du har valt en produkt som kommer med årtionden av yrkeserfarenhet och innovation. Den är genialisk och elegant, och den har den utformats med dig i åtanke. När du än använder den kan du känna dig trygg med att veta att du får fantastiska resultat varje gång.

Välkommen till Electrolux.

Besök vår webbplats för att:



få tips om användning, broschyrer, felsökning, service- och reparationsinformation:
www.electrolux.com/support



registrera din produkt för bättre service:
www.registerelectrolux.com



köpa tillbehör, förbrukningsvaror och originalreservdelar till din produkt:
www.electrolux.com/shop



Ladda ner **My Electrolux Kitchen**-appen för fler recept, tips och felsökning.



KUNDTJÄNST OCH SERVICE

Använd alltid originalreservdelar.

Ha följande uppgifter till hands när du kontaktar vår auktoriserade serviceverkstad: Modell, artikelnummer, serienummer.

Informationen står på märkplåten.

 Varning/Försiktighet – Säkerhetsinformation

 Allmän information och tips

 Miljöinformation

Med reservation för ändringar.

INNEHÅLL

1. SÄKERHETSINFORMATION.....	161	2.7 Kassering.....	166
1.1 Säkerhet för barn och personer med funktionsnedsättning.....	161	3. PRODUKTBESKRIVNING.....	166
1.2 Allmän säkerhet.....	162	3.1 Allmän översikt.....	167
2. SÄKERHETSINSTRUKTIONER.....	163	3.2 Tillbehör.....	167
2.1 Installation.....	163	4. SÅ HÄR SLÅR DU PÅ OCH STÄNGER AV UGNEN.....	168
2.2 Elanslutning.....	164	4.1 Infällbara vred.....	168
2.3 Använd.....	164	4.2 Kontrollpanel.....	168
2.4 Underhåll och rengöring.....	165	5. FÖRE FÖRSTA ANVÄNDNING.....	170
2.5 Lampa inuti produkten.....	165	5.1 Första rengöring.....	170
2.6 Service.....	166		

5.2 Initial föruppvärmning.....	170	10. RÅD OCH TIPS.....	186
5.3 Trådlös anslutning 	170	10.1 Bakning med fukt.....	186
5.4 Programlicenser.....	171	10.2 Bakning med fukt - rekommenderade tillbehör.....	187
6. DAGLIG ANVÄNDNING.....	171	10.3 Tillagningstabeller för testinstitut.....	187
6.1		11. SKÖTSEL OCH RENGÖRING.....	189
Så här ställer du in: Tillagningsfunktion er.....	172	11.1 Anmärkningar om rengöring.....	189
6.2 Värmefunktioner.....	172	11.2 Hur man rengör: Fördjupning i ugnsutrymmet.....	190
6.3 Anvisningar om: Bakning med fukt.....	174	11.3 Hur man tar bort: Ugnstegar....	190
6.4		11.4 Så här använder du: Katalytisk rengöring	190
Så här ställer du in: Tillagningshjälp..	174	11.5	
6.5 Tillagningshjälp med recept.....	175	Hur man tar bort och installerar: Lucka n.....	191
7. KLOCKFUNKTIONER.....	179	11.6 Byte av: Lampa.....	192
7.1 Klockfunktioner.....	180	12. FELSÖKNING.....	193
7.2		12.1 Vad gör jag om	193
Så här ställer du in: Klockfunktioner..	180	12.2 Serviceinformation.....	195
8. ANVÄNDNING: TILLBEHÖR.....	181	13. ENERGIEFFEKTIVITET.....	195
8.1 Sätta in tillbehör.....	181	13.1 Produktinformation och produktinformationsblad*.....	195
8.2 Matlagningstermometer.....	182	13.2 Energibesparing.....	196
9. TILLVALSFUNKTIONER.....	184	14. MENYSTRUKTUR.....	196
9.1 Knapplås.....	184	14.1 Meny.....	196
9.2 Automatisk avstängning.....	184		
9.3 Kylfläkt.....	184		
9.4 Mekaniskt lucklås.....	185		
9.5 Så här använder du: Mekaniskt lucklås.....	185		

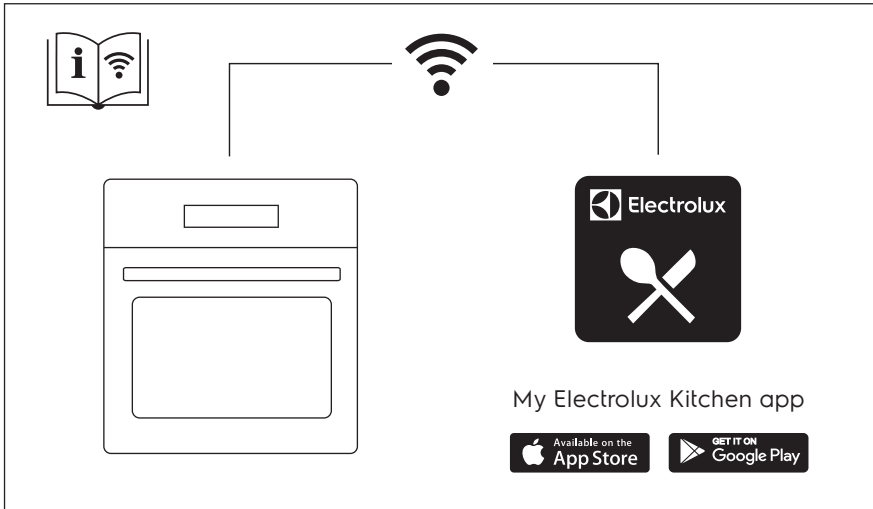

1. ⚠ SÄKERHETSINFORMATION

Läs noga de bifogade instruktionerna före installation och användning av produkten. Tillverkaren är inte ansvarig för eventuella personskador eller andra skador som uppkommit som ett resultat av felaktig installation eller användning. Förvara alltid bruksanvisningen på en säker och tillgänglig plats för framtida bruk.

1.1 Säkerhet för barn och personer med funktionsnedsättning

- Denna produkt kan användas av barn från 8 års ålder och uppåt, och av personer med nedsatt fysisk, sensorisk eller mental förmåga, samt personer med bristande erfarenhet och kunskap om de övervakas eller instrueras om hur produkten används på ett säkert sätt och förstår de risker som är förknippade med användningen. Barn under 8 år eller personer med mycket omfattande och komplexa funktionsnedsättningar ska inte vistas i närheten av produkten utan ständig uppsikt.

- Barn ska hållas under uppsikt så att de inte leker med produkten och mobilenheter med My Electrolux Kitchen.
- Håll allt förpackningsmaterial utom räckhåll för barn och kassera det på lämpligt sätt.
- **WARNING!** Barn och husdjur ska hållas borta från produkten när den är igång eller när den svalnar. Åtkomliga delar blir heta under användning.
- Om maskinen har ett barnlås ska den aktiveras.
- Barn får inte utföra rengöring och underhåll av produkten utan uppsikt.

1.2 Allmän säkerhet

- Installation av denna produkt och byte av kabeln får endast utföras av behörig person.
- Använd inte produkten innan den har installerats i inbyggnadsstrukturen.
- Bryt strömförsörjningen till apparaten före utförande av underhåll.
- Om nätsladden är skadad måste den bytas av tillverkaren, tillverkarens auktoriserade servicecenter eller personer med motsvarande utbildning, för att undvika elektrisk fara.
- **WARNING:** Kontrollera att produkten är avstängd innan du byter lampa för att undvika risken för elstötar.
- **WARNING:** Produkten och åtkomliga delar blir mycket varma under användning. Var försiktig så att du undviker att vidröra värmeelementen.
- Använd alltid ugnsvantar för att ta ut eller sätta in tillbehör eller eldfasta formar.
- Använd endast matlagningstermometern som rekommenderas för den här produkten.
- För att ta bort ugnsstegen drar du först ut den främre delen av ugnsstegen och sedan den bakre delen från sidoväggarna. Sätt tillbaka ugnsstegen i omvänd ordning.
- Använd inte ångrengörare vid rengöring av produkten.

- Använd inte skarpa rengöringsmedel med slipeffekt eller vassa metallskrapor för att rengöra ugnsluckans glasskivor eftersom dessa kan repa ytan, vilket i sin tur kan leda till att glaset spricker.

2. SÄKERHETSINSTRUKTIONER

2.1 Installation

**VARNING!**

Endast en behörig person får installera den här produkten.

- Avlägsna allt förpackningsmaterial.
- Installera eller använd inte en skadad produkt.
- Följ installationsinstruktionerna som följer med produkten.
- Var alltid försiktig när produkten rör sig eftersom den är tung. Använd alltid skyddshandskar och täckta skor.
- Dra aldrig produkten i handtaget.
- Installera produkten på en säker och lämplig plats som uppfyller installationskraven.
- Minsta avstånd till andra produkter ska beaktas.
- Kontrollera, före installation av produkten, att ugnsluckan kan öppnas enkelt utan motstånd.
- Produkten är utrustad med ett elektriskt kylsystem. Den måste användas med den elektriska strömförsörjningen.
- En inbyggnad enhet måste uppfylla stabilitetskraven enligt DIN 68930.

Skåpets minimihöjd (minsta höjd för skåpet under bänk)	578 (600) mm
Skåpets bredd	560 mm
Skåpets djup	550 (550) mm
Höjd på produktens främre del	594 mm
Höjd på produktens bakre del	576 mm
Bredd på produktens främre del	595 mm
Bredd på produktens bakre del	559 mm
Produktens djup	567 mm
Inbyggnadsdjup för produkten	546 mm
Djup med öppen lucka	1027 mm

SÄKERHETSINSTRUKTIONER

Minsta storlek på ventilationsöppningen. Öppning placerad nedtill på vänstra sidan	560 x 20 mm
Nätsladdens längd. Kabeln är placerad i det nedre högra hörnet på baksidan	1500 mm
Monteringssskruvar	4 x 25 mm

2.2 Elanslutning



VARNING!

Risk för brand och elektriska stötar.

- Alla elektriska anslutningar ska göras av en behörig elektriker.
- Produkten måste jordas.
- Se till att de parametrarna på märkskylten överensstämmer med elnätets elektricitet.
- Använd alltid ett korrekt installerat, stötsäkert och jordat eluttag.
- Använd inte grenuttag eller förlängningssladdar.
- Kontrollera så att du inte skadar stickkontakten och nätkabeln. Om produktens nätkabel behöver bytas måste det göras av vårt auktoriserade servicecenter.
- Låt inte nätkablar komma i kontakt med eller komma nära produktens lucka eller nichen nedanför produkten, speciellt inte när den är igång eller om luckan är het.
- Stötskyddet för strömförande och isolerade delar måste fästas på ett sådant sätt att det inte kan tas bort utan verktyg.
- Anslut stickkontakten till eluttaget först vid slutet av installationen. Kontrollera att stickkontakten är åtkomlig efter installationen.
- Anslut inte stickkontakten om vägguttaget sitter löst.
- Dra inte i anslutningssladden för att koppla bort produkten från eluttaget. Ta alltid tag i stickkontakten.
- Använd endast rätt isoleringsenheter: strömbrytare, säkringar (säkringar av skruvtyp tas ur hållaren), jordfelsbrytare och kontaktorer.
- Den elektriska installationen måste ha en isolationsenhet så att du kan koppla från produkten från nätet vid alla poler. Kontaktöppningen på isolationsenheten måste vara minst 3 mm bred.
- Denna produkt levereras med en huvudkontakt och en huvudkabel

2.3 Använd



VARNING!

Risk för skador, brännskador, elstötar eller explosion föreligger.

- Denna produkt är endast avsedd för hushållsbruk.
- Ändra inte produktens specifikationer.
- Kontrollera att ventilationsöppningarna inte är blockerade.
- Låt inte produkten stå utan uppsikt under användning.
- Stäng av produkten efter varje användningstillfälle.
- Var försiktig när du öppnar produktens lucka medan produkten är påslagen. Varm luft kan strömma ut.

- Använd inte produkten med våta händer eller när den har kontakt med vatten.
- Tryck inte på den öppna luckan.
- Använd inte produkten som arbets- eller avlastningsyta.
- Öppna luckan försiktigt. Användning av ingredienser med alkohol kan orsaka blandning av alkohol och luft.
- Låt inte gnistor eller öppna lågor komma i kontakt med produkten när du öppnar luckan.
- Placera inte brandfarliga produkter eller föremål som är våta med brandfarliga produkter i, i närheten av eller på produkten.
- Dela inte ditt Wi-Fi-lösenord.

**WARNING!**

Risk för skador på produkten föreligger.

- För att förhindra skador eller missfärgning på emaljen:
 - placera inte eldfasta formar eller andra föremål direkt på ugnsbotten.
 - lägg inte aluminiumfolie direkt på ugnsbotten.
 - håll inte vatten direkt i den heta produkten.
 - Låt inte fuktiga maträtter eller matvaror stå kvar i produkten när tillagningen är klar.
 - var försiktig när du tar bort eller installerar tillbehören.
- Missfärgning av emaljen eller den rostfria ytan påverkar inte produktens funktion.
- Använd en djup form för mjuka kakor. Fruk juice kan orsaka fläckar som inte går att ta bort.
- Denna produkt är endast avsedd för matlagning. Den får inte användas för andra ändamål, t.ex. rumsuppvärmning.
- Tillaga alltid med ugnsluckan stängd.
- Om produkten installeras i till exempel ett skåp, se till att skåpsdörren aldrig är stängd när produkten är i drift. Värme och fukt kan byggas upp bakom en stängd lucka och orsaka skador på produkten, skåpsmöblerna eller golvet. Stäng inte luckan förrän produkten har svalnat helt efter användning.

2.4 Underhåll och rengöring

**WARNING!**

Det finns risk för personskador, brand eller skador på produkten.

- Stäng av produkten och koppla bort den från eluttaget före underhåll.
- Se till att produkten har svalnat. Det finns även risk för att glaspanelerna kan spricka.
- Byt omedelbart ut luckans glaspaneler om de är skadade. Kontakta auktoriserat servicecenter.
- Var försiktig när du tar bort luckan. Luckan är tung!
- Rengör produkten regelbundet för att förhindra att ytmaterialiet försämrats.
- Rengör produkten med en fuktig, mjuk trasa. Använd bara milda rengöringsmedel. Använd inte produkter med slip-effekt, skursvampar, lösningsmedel eller metallföremål.
- Om du använder en ugnssprej ska du följa säkerhetsanvisningarna på förpackningen.
- Rengör inte den katalytiska emaljen med rengöringsmedel.

2.5 Lampa inuti produkten

**WARNING!**

Risk för elektrisk stöt!

PRODUKTBESKRIVNING

- När det gäller lampan/lamporna i denna produkt och reservlampor som säljs separat: Dessa lampor är avsedda att tåla extrema fysiska förhållanden i hushållsapparater, såsom temperatur, vibration, fuktighet eller är avsedda att signalera information om produktens driftsstatus. De är inte avsedda att användas i andra produkter eller som rumsbelysning i hemmet.
- Använd bara lampor med samma specifikationer.

2.6 Service

- Kontakta en auktoriserad serviceverkstad för reparation av produkten.
- Använd endast originaldelar.

2.7 Kassering

**WARNING!**

Risk för kvävning eller skador.

- Koppla loss produkten från eluttaget.
- Klipp av elkabeln nära produkten och kassera den.
- Ta bort luckspärren för att förhindra att barn eller husdjur blir instängda i maskinen.

3. PRODUKTBESKRIVNING

3.1 Allmän översikt

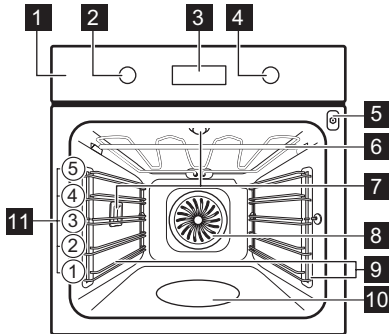

- 1** Kontrollpanel
- 2** Funktionsratt för tillagningsfunktioner
- 3** Display
- 4** Inställningsratt
- 5** Uttag för matlagningstermometern
- 6** Värmeelement
- 7** Lampa
- 8** Fläkt
- 9** Ugnsstegar, borttagbara
- 10** Ugnsutrymmets upphöjning
- 11** Hyllplaceringar

3.2 Tillbehör

Galler

För kokkär, kakformar, stekar.

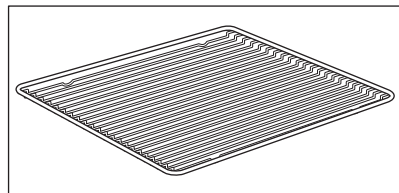

SÅ HÄR SLÅR DU PÅ OCH STÄNGER AV UGNEN

Bakplåt

För kakor och småkakor.

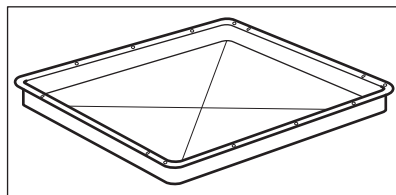

Grill- / stekpanna

För bakning och stekning eller som fettuppsamlingsfat.

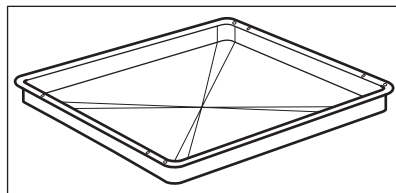

Bakplåt

För småfranska, kringlor och små bakverk.
Lämplig för ångfunktioner. Ytans missfärgning påverkar inte dess funktionsduglighet.

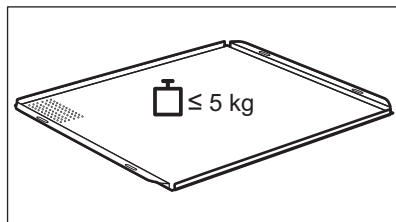

Matlagningstermometer

För att mäta temperaturen inuti maten.

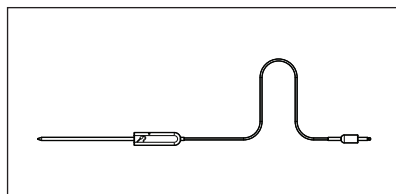







4. SÅ HÄR SLÅR DU PÅ OCH STÄNGER AV UGNEN

4.1 Infällbara vred

För att använda produkten, tryck på kontrollvredet. Vredet kommer ut.









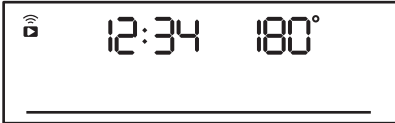
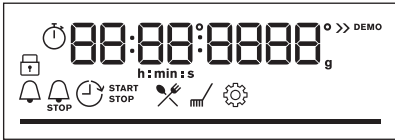



4.2 Kontrollpanel

Sensorområden på kontrollpanelen					Tryck på	Vrid ratten
 Timer	 Snabbuppvärmning	 Belysning	 Matlagningstermometern	OK		



SÅ HÄR SLÅR DU PÅ OCH STÄNGER AV UGNEN

Sensorområden på kontrollpanelen	Tryck på	Vrid ratten
Välj en tillagningsfunktion för att sätta på ugnen.		
Ugnen stängs av genom att funktionsratten ställs i avstängt läge.		

	Om funktionsratten ställs i avstängt läge sätts displayen i standby-läge.
	När du lagar mat visar displayen den inställda temperaturen, klockslag och andra tillgängliga alternativ.
	Displayen med maximalt antal funktioner inställda.

Indikeringar på displayen				
 Knapplås	 Tillagningshjälp	 Rengöring	 Inställningar	 Snabbuppvärmning
Timerindikatorer:				
Wi-Fi-indikator - blinkar när ugnen kan anslutas till Wifi-nätverket.		Fjärrstyrning-indikator – ugnen kan fjärrstyras.		
 Wi-Fi-anslutningen är påslagen.		 Fjärrstyrning är påslagen.		
Förloppsindikator - visar uppnådd temperatur eller tid.				

FÖRE FÖRSTA ANVÄNDNING

Indikator för ångtillagning	
Matlagningstermometer Indikator	

5. FÖRE FÖRSTA ANVÄNDNING



WARNING!

Se säkerhetsavsnitten.

5.1 Första rengöring

Före den första användningen ska den tomma ugnen rengöras och tiden ställas in på:



00:00

Ställ in tidtagningen. Tryck på OK.

5.2 Initial föruppvärmning



Värm upp den tomma ugnen före första användning.

Steg 1 Ta ut alla tillbehör och flyttbara ugnsstegar ur ugnen.

Steg 2 Ställ in maxtemperatur för funktionen: 
Låt ugnen stå på i en timme.

Steg 3 Ställ in maxtemperatur för funktionen: 
Låt ugnen stå på i 15 minuter.

 Ugnen kan avge lukt och rök under föruppvärmning. Se till att rummet är ventilerat.

5.3 Trådlös anslutning

För att ansluta ugnen behöver du:

- Trådlöst nätverk med internetanslutning.
- Mobil enhet ansluten till ditt trådlösa nätverk.

Steg 1	Ladda ner mobilappen My Electrolux Kitchen och följ instruktionerna för kommande steg.
Steg 2	Vrid på ratten för att välja:  .

Frekvens	WLAN 2,4 Ghz	WLAN 5 Ghz
	2 400–2 483,5 Mhz	5 150–5 350 MHz 5 470–5 725 MHz
Protokoll	IEEE 802.11b DSSS, 802.11g/n OFDM	IEEE 802.11 a/n OFDM
Max. effekt	EIRP <20 dBm (100 mW)	EIRP <23 dBm (200 mW)
WiFi-modul	NIU5-50	

Frekvens Bluetooth	2 400–2 483,5 Mhz
Protokoll	LE: DSSS
Max. effekt	EIRP <4 dBm (2,5 mW)

EU-länderna som omfattas av direktivet 2014/53/EU: Belgien, Bulgarien, Tjeckien, Danmark, Tyskland, Estland, Irland, Grekland, Spanien, Frankrike, Kroatien, Italien, Cypern, Lettland, Litauen, Luxemburg, Ungern, Malta, Nederländerna, Österrike, Polen, Portugal, Rumänien, Slovenien, Slovakien, Finland, Sverige, Norge, Schweiz, Storbritannien, Turkiet.



5.4 Programlicenser



Programvaran i den här produkten innehåller komponenter som baseras på fri och öppen källkod. Electrolux bekräftar de öppna programvarans och robotgemenskapernas bidrag till utvecklingsprojektet.
För att komma åt källkoden för dessa kostnadsfria och öppna programvarukomponenter vars licensvillkor kräver publicering och för att se deras fullständiga upphovsrättsinformation och tillämpliga licensvillkor, besök: http://electrolux.opensoftwarerepository.com (mapp NIU5).

6. DAGLIG ANVÄNDNING

 WARNING! Se säkerhetsavsnitten.
--

6.1 Så här ställer du in: Tillagningsfunktioner









Börja tillagningen	
Steg 1	Steg 2
	
Ställ in en tillagningsfunktion.	Ställ in temperaturen.

Ångtillagning			
Se till att ugnen är kall.			
Steg 1	Steg 2	Steg 3	Steg 4
			Förvärm den tomma ugnen i 10 minuter för att skapa fuktighet. Sätt in maten i ugnen.
Fyll ugnens bottenfördjupning med kranvatten.	Välj ångtillagningsfunktionen.	Ställ in temperaturen.	
<p>i Ugnsutrymmets fördjupning rymmer 250 ml. Fyll inte på ugnens botten när ugnen är påslagen eller medan den fortfarande är varm.</p>			

När ångtillagningen har avslutats:		
Steg 1	Steg 2	Steg 3
Stäng av ugnen genom att ställa funktionsratten i avstängt läge.	Öppna luckan försiktigt. Ånga som släpps ut kan orsaka brännskador.	Se till att ugnen är kall. Ta bort kvarvarande vatten från ugnsutrymmets nedsänkning.

6.2 Värmefunktioner

Standardtillagningsfunktioner

Tillagningsfunktion	Användning
 <p>Varmluft</p>	För bakning eller torkning på upp till tre ugnsnivåer samtidigt. Välj en temperatur 20 till 40 °C lägre än för Över-/undervärme.
 <p>Över-/undervärme</p>	Bakning och stekning på en ugnsnivå.
 <p>SteamBake</p>	För att tillsätta fukt under tillagningen. För att få den rätta färgen och krispigheten under gräddning. För att få rätten saftigare under uppvärmning. Konservering av frukt eller grönsaker.
 <p>Pizza/Paj</p>	För att tillaga pizza. För att bryna ordentligt och få en knaprig botten.
 <p>Undervärme</p>	För bakning av kakor med knaprig botten och för konservering av livsmedel.
 <p>Fryst mat</p>	För tillagning av snabbmat (som pommes frites, klyftpotatis och vårrullar) med en krispig effekt.
 <p>Bakning med fukt</p>	Denna funktion är för att spara energi under tillagningen. När du använder den här funktionen kan temperaturen i ugnen skilja sig från inställd temperatur. Restvärmen används. Värmeeffekten kan minskas. Mer information finns i kapitlet "Daglig användning" och anvisningar om: Bakning med fukt.
 <p>GRILL</p>	För grillning av tunnskurna stycken och brödrostning.
 <p>Varmluftsgrillning</p>	Varmluftstekning på första ugnsnivån av större köttstycken eller fågelkött med ben. För att bryna och göra gratänger.

Tillagningsfunktion	Användning
 Meny	Så här öppnar du menyn: Tillagningshjälp, Rengöring, Inställningar.

6.3 Anvisningar om: Bakning med fukt

Denna funktion användes för att uppfylla kraven för energieffektivitet och ekodesign enligt EU 65/2014 och EU 66/2014. Provnings enligt EN 60350-1.

Ugnsluckan ska vara stängd under tillagningen så att funktionen inte avbryts och ugnen fungerar med högsta möjliga energieffektivitet.







Om du använder den här funktionen släcks lampan automatiskt efter 30 sekunder.

För tillagningsinstruktioner, se kapitlet "Råd och tips", Bakning med fukt. För instruktioner om allmän energibesparing, se kapitlet "Energieffektivitet", Energibesparing.





6.4 Så här ställer du in: Tillagningshjälp

Varje maträtt i denna undermeny har en föreslagen funktion och temperatur. Tiden och temperaturen kan justeras under tillagningen.









För vissa maträtter kan tillagningen också styras med:	I vilken grad maträtten ska tillagas:
<ul style="list-style-type: none"> Matlagningstermometer 	<ul style="list-style-type: none"> Rare Medel Välstekt

Tillagningshjälp - använd det för att tillaga en maträtt snabbt med standardinställningar:			
Steg 1	Steg 2	Steg 3	Steg 4
 	 	 1 - 45	 OK
Öppna menyn.	Välj Tillagningshjälp. Tryck på OK.	Välj maträtt. Tryck på OK.	Sätt in maträtten i ugnen. Bekräfta inställning.







6.5 Tillagningshjälp med recept



















Teckenförklaring	
	Matlagningstermometer tillgängligt. Placera Matlagningstermometer i den tjockaste delen av rätten. Ugnen stängs av när inställd Matlagningstermometer temperatur har uppnåtts.
	Mängden vatten för ångfunktionen.
	Förvärm ugnen innan du startar tillagningen.
	Ugnsnivå.

När funktionen har avslutats, kontrollera om maten är klar.

	Maträtt	Vikt	Ugnsnivå / tillbehör	Program-tid
Nötkött 				
P1	Rostbiff, röd	1–1,5 kg; skivor med tjocklek 4–5 cm	  2; bakplåt Stek köttet i några minuter i en het stekpanna. Sätt in i ugnen.	~ 40 min
P2	Rostbiff, medium			~ 50 min
P3	Rostbiff, välstekt			~ 60 min
P4	Stek, medium	180–220 g per stycke; 3 cm tjocka skivor	   3; stekfat på galler Stek köttet i några minuter i en het stekpanna. Sätt in i ugnen.	~ 15 min
P5	Rostbiff/bräserad (revbensspjäll, rund, tjock flé)	1,5–2 kg	  2; stekfat på galler Stek köttet i några minuter i en het stekpanna. Tillsätt vätska. Sätt in i ugnen.	~ 120 min



















DAGLIG ANVÄNDNING

	Maträtt	Vikt	Ugnsnivå / tillbehör	Programtid
P6	Rostbiff, röd (långsam tillagning)	1–1,5 kg; skivor med tjocklek 4–5 cm	 2; bakplåt Använd dina favoritkryddor eller bara salt och färsk malen peppar. Stek köttet i några minuter i en het stekpanna. Sätt in i ugnen.	~ 75 min
P7	Rostbiff, medium (långsam tillagning)			~ 85 min
P8	Rostbiff, välstekt (långsam tillagning)			~ 130 min
P9	Filé, röd (långsam tillagning)	0,5–1,5 kg; 5–6 cm tjocka bitar	 2; bakplåt Använd dina favoritkryddor eller bara salt och färsk malen peppar. Stek köttet i några minuter i en het stekpanna. Sätt in i ugnen.	~ 75 min
P10	Filé, medium (långsam tillagning)			~ 90 min
P11	Filé, klar (långsam tillagning)			~ 120 min
Kalvkött 🍖				
P12	Kalvstek (t.ex. bog)	0,8–1,5 kg; 4 cm tjocka bitar	 2; stekfat på galler Använd dina favoritkryddor. Tillsätt vätska. Täckt stek.	~ 80 min
Fläskkött 🍖🐷				
P13	Fläskstek, hals eller bog	1,5–2 kg	 2; stekfat på galler Vänd köttet efter halva tillagningstiden.	~ 120 min
P14	Pulled pork LTC	1,5–2 kg	 2; bakplåt Använd dina favoritkryddor. Vänd köttet efter halva tillagningstiden för att få en jämn bryning.	~ 215 min
P15	Karré, färsk	1–1,5 kg; 5–6 cm tjocka skivor	 2; stekfat på galler Använd dina favoritkryddor.	~ 55 min

	Maträtt	Vikt	Ugnsnivå / tillbehör	Programtid
P16	Revbensspjäll	2–3 kg; använd råa, 2–3 cm tjocka revbensspjäll	 3 långpanna Tillsätt vätska så att botten täcks i stekfatet. Vänd köttet efter halva tillagningstiden.	90 min
Lamm 				
P17	Lammfiol med ben	1,5–2 kg; 7–9 cm tjocka stycken	  2; stekfat på galler Tillsätt vätska. Vänd köttet efter halva tillagningstiden.	~ 130 min
Fågelkött 				
P18	Hel kyckling	1–1,5 kg; färsk	  2;  200 ml; stekgryta på plåt Använd dina favoritkryddor. Vänd köttet efter halva tillagningstiden för att få en jämn bryning.	~ 60 min
P19	Halv kyckling	0,5–0,8 kg	  3; bakplåt Använd dina favoritkryddor.	~ 40 min
P20	Kycklingbröst	180–200 g per bit	   2; stekgryta på galler Använd dina favoritkryddor. Stek köttet i några minuter i en het stekpanna.	~ 25 min
P21	Kycklinglår, färska	-	  3; bakplåt Om du har marinerat kycklingbenen, välj en lägre temperatur och längre tillagningstid.	~ 30 min
P22	Hel anka	2–3 kg	  2; stekfat på galler Använd dina favoritkryddor. Lägg köttet på stekfatet. Vänd köttet efter halva tillagningstiden.	~ 100 min
P23	Hel gås	4–5 kg	  2 långpanna Använd dina favoritkryddor. Lägg köttet på en djup bakplåt. Vänd gåsen efter halva tillagningstiden.	~ 110 min





DAGLIG ANVÄNDNING

	Maträtt	Vikt	Ugnsnivå / tillbehör	Program-tid
Annat 🍷				
P24	Köttfärslimpa	1 kg	🔪 ☑️ 2; galler Använd dina favoritkryddor.	~ 60 min
Fisk 🐟				
P25	Hel fisk gril-lad	0,5–1 kg per fisk	🔪 ☑️ 2; bakplåt Fyll fisken med smör och använd dina favoritkryddor och örter.	~ 30 min
P26	Fiskfilé	-	🍳 ☑️ 3; stekgryta på galler Använd dina favoritkryddor.	20 min
Söta bakverk/efterrätter 🍰 🍩 🍪				
P27	Cheesecake	-	☑️ 2; ∅ 28 cm springform på galler	90 min
P28	Äppelkaka	-	☑️ 2; 🍷 100–150 ml bakplåt	60 min
P29	Äppelpaj	-	☑️ 2; pajform på galler	40 min
P30	Äppelpaj	-	☑️ 2; 🍷 100–150 ml; ∅ 22 cm paj-form på galler	60 min
P31	Brownies	2 kg	☑️ 3; långpanna	30 min
P32	Chokladmuffins	-	☑️ 2; 🍷 100–150 ml; muffinsbricka på galler	30 min
P33	Limpkaka	-	☑️ 2 brödform på galler	50 min
Grönsaker/smårätter 🥬 🥕 🌿				
P34	Bakad potatis	1 kg	☑️ 2; bakplåt Lägg hela potatisar med skal på bakplåten.	50 min



	Maträtt	Vikt	Ugnsnivå / tillbehör	Program-tid
P35	Klyftor	1 kg	 3 bakplåt täckt med bakplåtspapper Använd dina favoritkryddor. Skär potatisen i bitar.	35 min
P36	Grillade grönsaker	1–1,5 kg	 3 bakplåt täckt med bakplåtspapper Använd dina favoritkryddor. Skär grönsakerna i bitar.	30 min
P37	Croquettes, frysta	0,5 kg	 3; bakplåt	25 min
P38	Pommes frites, frysta	0,75 kg	 3; bakplåt	25 min
Gratänger, bröd och pizza   				
P39	Lasagne/nudelgryta	1–1,5 kg	 2; stekgryta på galler	45 min
P40	Potatisgratäng	1–1,5 kg	 1; stekgryta på galler	50 min
P41	Färsk pizza, tunn	-	  2; لسا 100 ml; bakplåt täckt med bakplåtspapper	15 min
P42	Färsk pizza, tunn	-	  2; لسا 100 ml; bakplåt täckt med bakplåtspapper	25 min
P43	Quiche	-	 2 bakform på galler	45 min
P44	Baguette/ciabatta/ljust bröd	0,8 kg	   3; لسا 150 ml; bakplåt täckt med bakplåtspapper Mer tid behövs för ljust bröd.	30 min
P45	Blandkorn/rågbröd/mörkt blandkornsbröd i form	1 kg	  2; لسا 150 ml; bakplåt täckt med bakplåtspapper / galler	45 min







7. KLOCKFUNKTIONER

7.1 Klockfunktioner

Klockfunktion	Program
	Signalur. När den inställda tiden har gått avges en ljudsignal.
	Tillagningstid. När inställd tid har gått avges en ljudsignal och tillagningsfunktionen stoppas.
	Tidsfördröjning. För att fördröja tillagningens start- och/eller sluttid.
	Upptimer. Längsta möjliga tid är 23 tim och 59 min. Denna funktion påverkar inte ugnens funktioner i övrigt. Slå på och stäng av Upptimer genom att välja: Meny, Inställningar.





7.2 Så här ställer du in: Klockfunktioner

Så här ställer du in: Klockslag		
Steg 1	Steg 2	Steg 3
		
Ändra tidpunkt genom att öppna menyn och välja Inställningar och Tidpunkt.	Ställ tiden	Tryck på: OK.

Så här ställer du in: Signalur			
Steg 1	Displayen visar: 0:00 	Steg 2	Steg 3
			
Tryck på: 		Ställ in Signalur	Tryck på: OK.
 Timern startar nedräkningen omedelbart.			







ANVÄNDNING: TILLBEHÖR

Så här ställer du in: Tillagningstid

Steg 1	Steg 2	Displayen visar: 0:00  STOP	Steg 3	Steg 4
				
Välj en tillagningsfunktion och ställ in temperaturen.	Tryck upprepade gånger på:  .		Ställ in tillagningstiden.	Tryck på: OK.

 Timern startar nedräkningen omedelbart.

Så här ställer du in: Tidsfördröjning

Steg 1	Steg 2	Displayen visar: tidpunkt  START	Steg 3	Steg 4	Displayen visar: --:--  STOPP	Steg 5	Steg 6
							
Välj tillagningsfunktion.	Tryck upprepade gånger på:  .		Ställ in starttiden.	Tryck på: OK.		Ställ in sluttiden.	Tryck på: OK.

 Timern börjar nedräkningen vid inställd starttid.

8. ANVÄNDNING: TILLBEHÖR

8.1 Sätta in tillbehör

Liten inbuktning upptill ökar säkerheten. Fördjupningarna ger också ett tippskydd. Den höga kanten runt hyllan förhindrar kokkärnen från att glida ner.

ANVÄNDNING: TILLBEHÖR

Galler:

För in gallret mellan skenorna på ugnstegen .

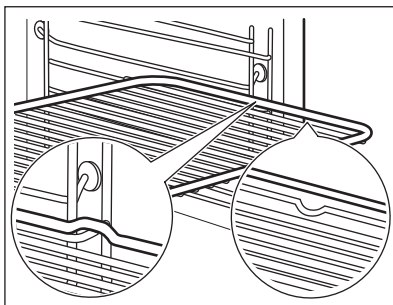

Bakplåt /Djup form:

Skjut in plåten mellan stegparen på önskad nivå.

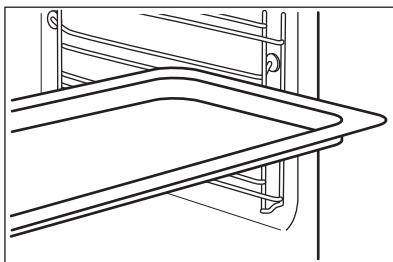

Galler, Bakplåt /Djup form:

Tryck in plåten mellan skenorna på hyllstöden och ugnsgallret på skenorna ovan.

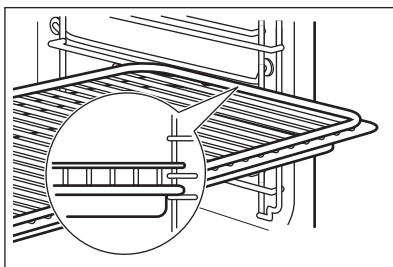

8.2 Matlagningstermometer

Matlagningstermometer- mäter temperaturen inuti maten.

Två temperaturer ska ställas in:



°C
Ugnstemperaturen.



Tillagningstemperaturen.

För bästa resultat:

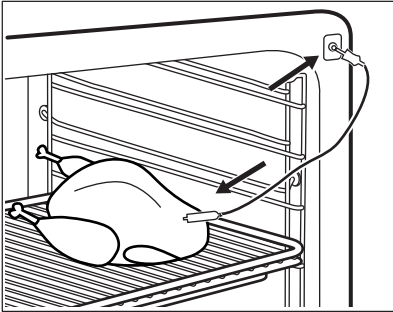
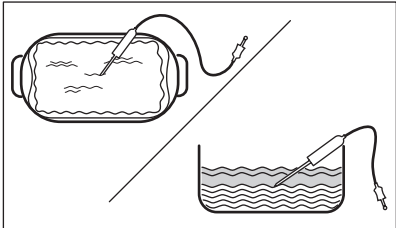
Ingredienserna ska hålla rumstemperatur.	Den är inte lämplig för flytande rätter.	Under tillagning ska den vara inuti maten.
--	--	--







Så här använder du: Matlagningstermometer

Steg 1	Slå på ugnen.
Steg 2	Ställ in en tillagningsfunktion och, vid behov, ugnstemperatur.
Steg 3	Sätt in: Matlagningstermometer.
Kött, fågel och fisk	Gryta
Sätt i spetsen på Matlagningstermometer i mitten av köttet eller fisken eller i den tjockaste delen. Se till att minst 3/4 av Matlagningstermometer är instucken.	Placera spetsen på Matlagningstermometer mitt i ugnsrätten. Matlagningstermometer ska sitta stabilt på samma ställe under tillagningen. Sätt den i en massiv del av maten. Använd kanten på formen som stöd för silikonhandtaget på Matlagningstermometer. Spetsen på Matlagningstermometer får inte komma i kontakt med formens botten.
	
Steg 4	Anslut Matlagningstermometer i uttaget framtill i ugnen. På displayen visas aktuell temperatur för: Matlagningstermometer.
Steg 5	 - tryck för att ställa in tillagningstemperaturen.
Steg 6	OK – tryck för att bekräfta. En ljudsignal avges när maten når den inställda temperaturen. Du kan välja att stoppa eller fortsätta tillagningen för maten ska bli tillräckligt tillagad.

Steg 7	Dra ut Matlagningstermometer ur uttaget och ta ut maten ur ugnen.  WARNING! Det finns risk för brännskador när Matlagningstermometer blir het. Var försiktig när du drar ut den från kontakten och från maten.
---------------	--



9. TILLVALSFUNKTIONER

9.1 Knapplås

Funktionen förhindrar att ugnsfunktionen ändras oavsiktligt.		
Sätt på den när ugnen är igång – den angivna matlagningen fortsätter, kontrollpanelen är låst. Slå på den när ugnen är avstängd – ugnen kan inte sättas på, kontrollpanelen är låst.		
 	 OK – tryck och håll inne för att slå på funktionen. En ljudsignal hörs.	 OK – tryck och håll inne för att stänga av den.
 3 x  – blinkar när låset slås på.		

9.2 Automatisk avstängning

Av säkerhetsskäl stängs ugnen av efter en tid om en uppvärmningsfunktion är aktiv och inga inställningar ändras.

 (°C)	 (tim)
30 - 115	12.5
120 - 195	8.5
200 - 245	5.5
max 250	3

Automatisk avstängning fungerar inte med funktionerna: Belysning, Matlagningstermometer, Tidsfördröjning.

9.3 Kylfläkt

När ugnen är på, slås kylfläkten på automatiskt för att hålla ugnens ytor svala. Om du stänger av ugnen kan kylfläkten fortsätta att vara igång tills ugnen är sval.

9.4 Mekaniskt lucklås

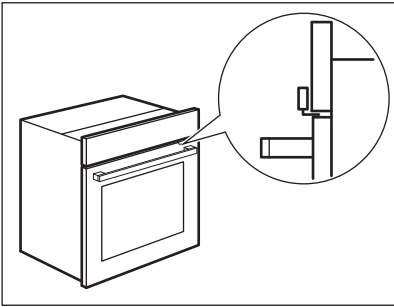
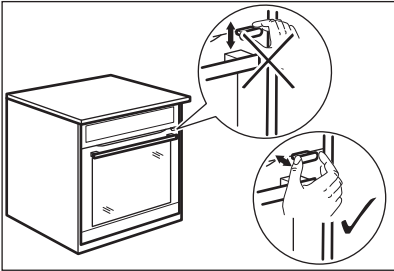
<p>Luckan är oläst vid leverans.</p>	
<p>⚠ FÖRSIKTIGHET! Flytta inte lucklåset vertikalt. Tryck inte på lucklåset när du stänger ugnsluckan.</p>	

9.5 Så här använder du: Mekaniskt lucklås

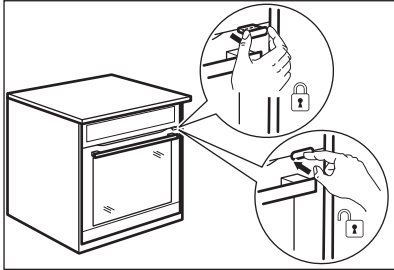
<p>Steg 1</p>	<p>Lås luckan genom att dra lucklåset framåt tills det låses på plats.</p>
<p>Steg 2</p>	<p>Lås upp luckan genom att trycka tillbaka lucklåset i panelen.</p> 

Öppna den låsta luckan

Du kan öppna luckan när lucklåset är låst.

Steg 1

Tryck på lucklåset något och öppna luckan genom att dra i den med handtaget.

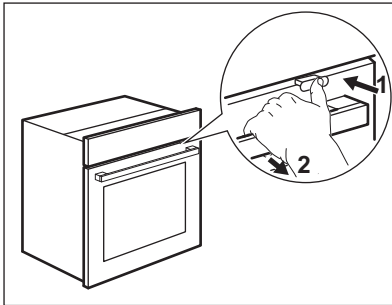



När du stänger luckan, se till att lucklåset är låst.

10. RÅD OCH TIPS





10.1 Bakning med fukt

För bästa resultat ska du följa förslagen som listas i tabellen nedan. Använd den tredje hyllnivån.

	 (°C)	 (min.)
Pastagrätäng	200 - 220	45 - 55
Potatisgrätäng	180 - 200	70 - 85
Moussaka	170 - 190	70 - 95
Lasagne	180 - 200	75 - 90
Cannelloni,	180 - 200	70 - 85
Brödpudding	190 - 200	55 - 70
Risgrynspudding	170 - 190	45 - 60
Äppelkaka på sockerkakssmet (rund kakform)	160 - 170	70 - 80
Franskbröd	190 - 200	55 - 70

10.2 Bakning med fukt - rekommenderade tillbehör







Använd mörka och icke reflekterande burkar och formar. De absorberar värme bättre än ljusa färger och reflektiva formar.

			
Pizzaform	Ugnsform	Portionsform	Tårtbottenform
Mörk, icke reflekterande 28 cm i diameter	Mörk, icke reflekterande 26 cm i diameter	Keramik 8 cm diameter, 5 cm hög	Mörk, icke reflekterande 28 cm i diameter

10.3 Tillagningstabeller för testinstitut

Information till provanstalter

Tester enligt: EN 60350, IEC 60350.





 BAKNING PÅ EN NIVÅ. Bakverk i formar				
		 (°C)	 (min.)	
Sockerkaka utan fett	Varmluft	140 - 150	35 - 50	2
Sockerkaka utan fett	Över-/undervärme	160	35 - 50	2
Äppelpaj, 2 st 20 cm formar	Varmluft	160	60 - 90	2
Äppelpaj, 2 st 20 cm formar	Över-/undervärme	180	70 - 90	1



BAKNING PÅ EN NIVÅ. Småkakor







Använd den tredje hyllpositionen.

		 (°C)	 (min.)
Mördegskakor / Mördegskakor	Varmluft	140	25 - 40
Mördegskakor / Mördegskakor, förvärm den tomma ugnen	Över-/undervärme	160	20 - 30
Småkakor, 20 st/plåt, förvärm den tomma ugnen	Varmluft	150	20 - 35
Småkakor, 20 st/plåt, förvärm den tomma ugnen	Över-/undervärme	170	20 - 30



BAKNING PÅ FLERA NIVÅER. Småkakor

		 (°C)	 (min.)	
Mördegskakor / Mördegskakor	Varmluft	140	25 - 45	1 / 4
Småkakor, 20 st/plåt, förvärm den tomma ugnen	Varmluft	150	23 - 40	1 / 4
Sockerkaka utan fett	Varmluft	160	35 - 50	1 / 4



Förvärm den tomma ugnen i 5 minuter.



Grillning med maximal temperaturinställning.



(min.)



Rostat bröd

GRILL

1 - 3

5

Nötstek, vänd efter halva tiden

GRILL

24 - 30

4

11. SKÖTSEL OCH RENGÖRING



WARNING!

Se säkerhetsavsnitten.

11.1 Anmärkningar om rengöring



Rengörings-
medel

Torka av framsidan av ugnen med en mjuk trasa med varmt vatten och mildt rengöringsmedel.

Använd en rengöringslösning för att rengöra metalleder.

Rengör fläckar med ett mildt rengöringsmedel. Applicera inte det på de katalytiska ytorna.



Används var-
je dag

Rengör ugnsutrymmet efter varje användningstillfälle. Fettansamling eller andra matrester kan leda till eldsvåda.

Låt inte maten stå i ugnen längre än 20 minuter. Torka av ugnsutrymmet med en mjuk trasa efter användning.

 <p>Tillbehör</p>	<p>Rengör alla ugnstillbehör efter varje användningstillfälle och låt dem torka. Använd en mjuk trasa med varmt vatten och mildt rengöringsmedel. Diska inte tillbehören i diskmaskin.</p>
	<p>Rengör inte tillbehör med nonstick-beläggning med ett rengöringsmedel med slipeffekt eller vassa föremål.</p>

11.2 Hur man rengör: Fördjupning i ugnsutrymmet

Rengör nedsänkningen i ugnsutrymmet från kalkavlagringar efter tillagning med ånga.

Steg 1	Steg 2	Steg 3
Häll 250 ml vitvinsvinäger i ugnsutrymmets nedsänkning. Använd högst 6 % vinäger utan tillsatser.	Låt vinägern lösa upp kalkavlagringarna i omgivningstemperatur under 30 minuter.	Rengör nedsänkningen med varmt vatten och en mjuk trasa.
För funktionen: SteamBake rengör ugnen efter 5–10 användningar.		

11.3 Hur man tar bort: Ugnsstegar

Ta bort ugnsstegarna vid rengöring av ugnen.

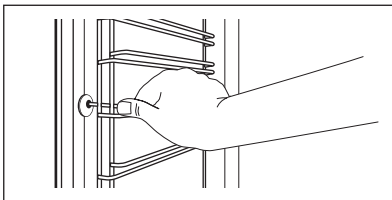
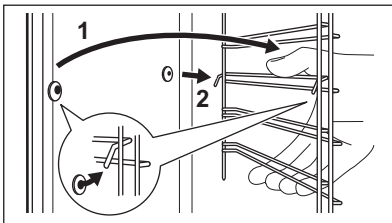

Steg 1	Stäng av ugnen och vänta tills den har svalnat.	
Steg 2	Dra först ut stegarnas främre del från sidoväggen.	
Steg 3	Dra ut stegen baktill från ugnsidan och ta bort den.	
Steg 4	Sätt tillbaka ugnsstegarna i omvänd ordning.	

11.4 Så här använder du: Katalytisk rengöring

Ugnsutrymmet är täckt med katalytisk emalj. Den absorberar fett under katalysen. Fläckar eller missfärgning av den katalytiska ytan påverkar inte rengöringen.

Rengör ugnen med katalytisk rengöring

Ta bort alla tillbehör före den katalytiska rengöringen.

Steg 1	Steg 2	Steg 3
Välj Meny  / Rengöring  och tryck på OK.	En ljudsignal hörs när rengöringen är klar. Ugnen stängs av.	När ugnen är kall, rengör den med en mjuk och fuktig trasa.
Varaktighet: 1 tim.		

11.5 Hur man tar bort och installerar: Luckan

Man kan ta loss och rengöra luckan och de inre glasrutorna. Antalet glaspaneler skiljer sig åt för olika modeller.



VARNING!

Luckan är tung.



FÖRSIKTIGHET!

Hantera glaset varsamt, särskilt runt den främre panelens kanter. Glaset kan gå sönder.

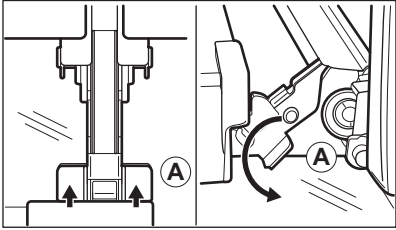
Steg 1	Öppna luckan helt.	
Steg 2	Lyft och tryck in klämspärarna (A) på de två gångjärnen till luckan.	
Steg 3	Stäng ugnsluckan till den första öppna positionen (ungefär 70° vinkel). Håll i luckan på båda sidorna och dra den ut från ugnen i en uppåtgående vinkel. Lägga ner luckan med utsidan neråt på en mjuk handduk på ett stabilt underlag.	

SKÖTSEL OCH RENGÖRING

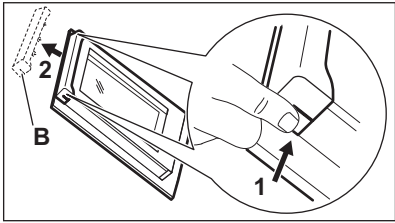
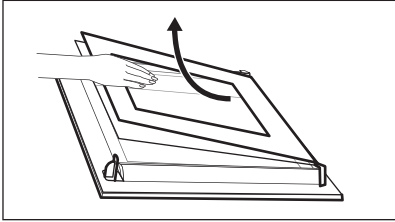
Steg 4	Ta tag i lucklisten (B) på båda sidorna av luckans övre kant och tryck inåt för att frigöra klämläset.	
Steg 5	Dra lucklisten framåt för att ta bort den.	
Steg 6	Håll glaset i överkanten ett i taget och dra dem uppåt och ut ur skenan.	
Steg 7	Rengör glaset med vatten och tvål. Torka luckglaset nogga. Diska inte glasskivorna i diskmaskin.	
Steg 8	Efter rengöring, utför stegen ovan i omvänd ordning.	
Steg 9	Sätt i det mindre ugnsglasets först, därefter det större och sist luckan. Se till att glaset är korrekt och ordentligt införda, annars kan luckans yta bli överhettad.	

11.6 Byte av: Lampa



WARNING!

Risk för elektrisk stöt!
Lampan kan vara het.

Innan du byter lampan:

Steg 1	Steg 2	Steg 3
Stäng av ugnen. Vänta tills ugnen är kall.	Koppla bort ugnen från eluttaget.	Lägg en trasa i botten av ugnstrymmet.

Övre lampa

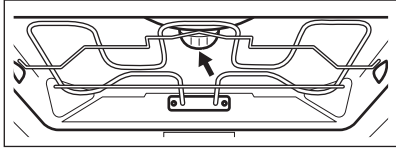
Steg 1	Ta bort glasskyddet genom att vrida på det.	
Steg 2	Rengör lampglaset.	
Steg 3	Byt ut lampan mot en lämplig lampa som tål 300 °C.	
Steg 4	Sätt tillbaka lampglaset.	

Sidolampa

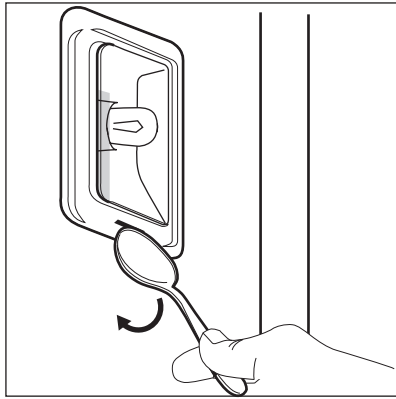
Steg 1	Ta ut den vänstra stegen för att komma åt lampan.	
Steg 2	Använd ett smalt och trubbigt föremål (t.ex. en tesked) för att avlägsna lampglaset.	
Steg 3	Rengör lampglaset.	
Steg 4	Byt ut lampan mot en lämplig lampa som tål 300 °C.	
Steg 5	Sätt tillbaka lampglaset.	
Steg 6	Sätt i vänster ugnsstega.	

12. FELSÖKNING



WARNING!

Se säkerhetsavsnitten.

12.1 Vad gör jag om ...

Om något saknas i denna tabell, kontakta ett auktoriserat servicecenter.



Ugnen slås inte på eller värms inte upp

Problem	Kontrollera att...
----------------	---------------------------



Ugnen slås inte på eller värms inte upp

Det går inte att aktivera eller använda ugnen.	Ugnen är korrekt ansluten till eluttaget.
Ugnen värms inte upp.	Den automatiska avstängningen är avaktiverad.
Ugnen värms inte upp.	Säkringen har inte löst ut.
Ugnen värms inte upp.	Barnlåset är avaktiverat.



Komponenter

Problem	Kontrollera att...
Belysningen är släckt.	Bakning med fukt - är påslagen.
Belysningen fungerar inte.	Glödlampan är trasig.
Funktionen Matlagningstermometer fungerar inte.	Kontakten till Matlagningstermometer är ordentligt isatt i uttaget.



Felkoder

Displayen visar ...	Kontrollera att...
Err C2	Matlagningstermometer kontakten har tagits bort från uttaget.
00:00	Ett strömavbrott har inträffat. Ställ in klockan.

Om displayen visar en felkod som inte finns i den här tabellen, slå av säkringen och slå på den igen för att starta om ugnen. Om felkoden återkommer, kontakta en auktoriserad serviceverkstad.



Rengöring

Problem	Kontrollera att...
---------	--------------------



Rengöring

Vattnet rinner ut ur bottenfördjupningen.

Det är för mycket vatten i bottenfördjupningen.

12.2 Serviceinformation

Kontakta din återförsäljare eller en auktoriserad serviceverkstad om du inte kan avhjälpa felet. Information som kundtjänst behöver finns på märkplåten. Typskylten sitter på ugnsutrymmets yttre kant. Avlägsna inte märkskylten från ugnsutrymmet.

Vi rekommenderar att du antecknar uppgifterna här:

Modell (MOD.)
Produktnummer (PNC)
Serienummer (S.N.)

13. ENERGIEFFEKTIVITET

13.1 Produktinformation och produktinformationsblad*

Leverantörens namn	Electrolux
Modellbeskrivning	COC826X 944032024
Energieffektivitetsindex	81.2
Energieffektivitetsklass	A+
Energiförbrukning med en standardrätt, över/undervärme	1.09 kWh/program
Energiförbrukning med en standardrätt, varmluft	0.69 kWh/program
Antal kaviteter	1
Värmekälla	Elektricitet
Ljudstyrka	71 l
Typ av ugn	Inbyggadsugn

MENYSTRUKTUR

Massa	33.0 kg
-------	---------

* För Europeiska unionen enligt EU-förordningarna 65/2014 och 66/2014.
För Republiken Vitryssland enligt STB 2478-2017, bilaga G; STB 2477-2017, bilagorna A och B.
För Ukraina enligt 568/32020.

Energieffektivitetsklassen är inte tillämplig för Ryssland.

EN 60350-1 - Elektriska matlagingsprodukter för hushållsbruk - Del 1: Områden, ugnar, ångugnar och grillar - Funktionsprovning.

13.2 Energibesparing



Denna ugn har funktioner som möjliggör energibesparing under tillagningen.

Kontrollera att ugnsluckan är ordentligt stängd när ugnen är påslagen. Öppna inte luckan för ofta under tillagningen. Håll luckans tätningslist är ren och kontrollera att den sitter rätt och ordentligt fast.

Använd kokkärl i metall för högre energieffektivitet.

Om möjligt, undvik att förvärma ugnen före tillagning.

Gör så korta uppehåll som möjligt vid tillagning av flera rätter för samma tillfälle.

Tillagning med varmluft

Om möjligt, använd varmluftsfunktionen för att spara energi.

Restvärme

Fläkten och belysningen fortsätter att vara påslagna. När du stänger av ugnen visas restvärme på displayen. Du kan använda den värmen för varmhållning.

Om tillagningen tar längre tid än 30 minuter, sänk ugnstemperaturen med minst 3–10 minuter innan tillagningen avslutas. Tillagningen fortsätter med ugnens restvärme.

Använd restvärmen för att värma annan mat.

Varmhållning

Välj lägsta möjliga temperaturinställning för att använda restvärme och hålla maten varm.

Restvärmeindikatorn eller temperaturen visas på displayen.

Laga mat med släckt belysning

Släck belysningen under tillagning. Tänd den endast när du behöver den.

Bakning med fukt

Denna funktion används för att spara energi under tillagningen.



Med denna funktion släcks belysningen automatiskt efter 30 sekunder. Du kan tända belysningen igen, men det innebär att förväntad energibesparing minskar.





14. MENYSTRUKTUR

14.1 Meny



- välj för att öppna Meny.

Meny-struktur		
Tillagningshjälp 	Rengöring 	Inställningar 

Steg 1	Steg 2	Steg 3	Steg 4	Steg 5
	 OK	 O1 - O14	 OK	
Välj Meny, Inställningar.	Bekräfta inställning.	Välj inställningen.	Bekräfta inställning.	Justera värdet och tryck på OK.

Inställningar					
O1	Klockslag	Ändra	O2	Ljusstyrka i display	1 - 5
O3	Knappljud	1 - Pip 2 - Klick 3 - Ljud av	O4	Ljudvolym	1 - 4
O5	Matlagningstermometer Åtgärd	1 - Larm och stopp 2 - Larm	O6	Upptimer	På/Av
O7	Belysning	På/Av	O8	Snabbuppvärmning	På/Av
O9	Wi-Fi	På/Av	O10	Automatisk fjärrstyrning	På/Av
O11	Glöm nätverk	ja/nej	O12	Demoläge	Aktiveringskod: 2468
O13	Programversion	Kontrollera	O14	Återställ alla inställningar	ja/nej

15. MILJÖSKYDD

Återvinn material med symbolen . Återvinn förpackningen genom att placera den i lämpligt kärl. Bidra till att skydda vår miljö och vår hälsa genom att återvinna avfall från elektriska och

elektroniska produkter. Släng inte produkter märkta med symbolen  med hushållsavfallet. Lämna in produkten på närmaste återvinningsstation eller kontakta kommunkontoret.

www.electrolux.com/shop



8673624 16-B-062021

