



BOSCH



Register your
new device on
MyBosch now and
get free benefits:
**[bosch-home.com/
welcome](https://bosch-home.com/welcome)**

Free standing cooker

HKA00.02.U, HKA00.020W, HKA050022W

[en] Instruction manual

Free standing cooker

Table of contents

 Intended use	4	 Appliance door	20
 Important safety information	4	Detaching and attaching the oven door	20
Halogen lamp	5	Removing and installing the door panels	21
 Causes of damage	6	Additional door safety	21
Hob	6	 Trouble shooting	22
Damage to the oven	6	Rectifying faults yourself	22
Damage to the plinth drawer	7	Replacing the bulb in the top of the cooking compartment	22
 Environmental protection	7	 Customer service	23
Saving energy	7	E number and FD number	23
Saving energy with the hob	8	 Tested for you in our cooking studio	23
Environmentally-friendly disposal	8	General information	23
 Installation and connection	9	Cakes and pastries	24
Electrical connection	9	Bakes and gratins	27
Adjacent units	9	Poultry, meat and fish	27
Wall fixing	9	Vegetables and side dishes	30
Door lock	9	Yoghurt	30
Measures to be noted during transport	9	Acrylamide in foodstuffs	30
 Getting to know your appliance	10	Preserving	31
General information	10	Prove dough	32
Cooking area	10	Test dishes	32
Control panel	11		
Cooking compartment	12		
 Accessories	12		
Accessories included	12		
Inserting accessories	12		
Optional accessories	13		
 Before using for the first time	14		
Cleaning the cooking compartment and accessories	14		
 Setting the cooking time	14		
Setting procedure	14		
Table of cooking times	14		
 Operating the appliance	16		
Switching the appliance on and off	16		
Setting the type of heating and temperature	16		
 Childproof lock	16		
Activating and deactivating	16		
 Cleaning	17		
Cleaning agents	17		
Keeping the appliance clean	19		
 Rails	19		
Detaching and refitting the rails	19		

Additional information on products, accessories, replacement parts and services can be found at www.bosch-home.com and in the online shop www.bosch-eshop.com

Intended use

Read these instructions carefully. Only then will you be able to operate your appliance safely and correctly. Retain the instruction manual and installation instructions for future use or for subsequent owners.

The images shown in these instructions are for guidance only.

Check the appliance for damage after unpacking it. Do not connect the appliance if it has been damaged in transport.

Only a licensed professional may connect appliances without plugs. Damage caused by incorrect connection is not covered under warranty.

This appliance is intended for private domestic use and the household environment only. The appliance must only be used for the preparation of food and beverages. The cooking process must be supervised. A short cooking process must be supervised without interruption. Only use the appliance in enclosed spaces.

This appliance is intended for use up to a maximum height of 4000 metres above sea level.

This appliance is not designed for operation with an external timer or by remote control.

Do not use inappropriate child safety shields or hob guards. These can cause accidents.

This appliance may be used by children over the age of 8 years old and by persons with reduced physical, sensory or mental capabilities or by persons with a lack of experience or knowledge if they are supervised or are instructed by a person responsible for their safety how to use the appliance safely and have understood the associated hazards.

Children must not play with, on, or around the appliance. Children must not clean the appliance or carry out general maintenance unless they are at least 15 years old and are being supervised.

Keep children below the age of 8 years old at a safe distance from the appliance and power cable.

Always slide accessories into the cooking compartment the right way round.

→ "Accessories" on page 12

Important safety information

Warning – Risk of fire!

- Combustible items stored in the cooking compartment may catch fire. Never store combustible items in the cooking compartment. Never open the appliance door if there is smoke inside. Switch off the appliance and unplug it from the mains or switch off the circuit breaker in the fuse box.
- A draught is created when the appliance door is opened. Greaseproof paper may come into contact with the heating element and catch fire. Do not place greaseproof paper loosely over accessories during preheating. Always weight down the greaseproof paper with a dish or a baking tin. Only cover the surface required with greaseproof paper. Greaseproof paper must not protrude over the accessories.
- Hot oil and fat can ignite very quickly. Never leave hot fat or oil unattended. Never use water to put out burning oil or fat. Switch off the hotplate. Extinguish flames carefully using a lid, fire blanket or something similar.
- The hotplates become very hot. Never place combustible items on the hob. Never place objects on the hob.
- The appliance becomes very hot, and flammable materials can easily catch fire. Do not store or use any flammable objects (e.g. aerosol cans, cleaning agents) under or in the vicinity of the oven. Do not store any flammable objects inside or on top of the oven.
- The surfaces of the plinth drawer may become very hot. Only store oven accessories in the drawer. Flammable and combustible objects must not be stored in the plinth drawer.

Warning – Risk of burns!

- The appliance becomes very hot. Never touch the interior surfaces of the cooking compartment or the heating elements. Always allow the appliance to cool down. Keep children at a safe distance.
- Accessories and ovenware become very hot. Always use oven gloves to remove accessories or ovenware from the cooking compartment.

- Alcoholic vapours may catch fire in the hot cooking compartment. Never prepare food containing large quantities of drinks with a high alcohol content. Only use small quantities of drinks with a high alcohol content. Open the appliance door with care.
- The hotplates and surrounding area (particularly the hob surround, if fitted) become very hot. Never touch the hot surfaces. Keep children at a safe distance.
- During operation, the surfaces of the appliance become hot. Do not touch the surfaces when they are hot. Keep children away from the appliance.
- The hotplate heats up but the display does not work. Switch off the circuit breaker in the fuse box. Contact the after-sales service.
- The appliance becomes hot during operation. Allow the appliance to cool down before cleaning.

⚠ Warning – Risk of scalding!

- The accessible parts become hot during operation. Never touch the hot parts. Keep children at a safe distance.
- When you open the appliance door, hot steam can escape. Steam may not be visible, depending on its temperature. When opening, do not stand too close to the appliance. Open the appliance door carefully. Keep children away.
- Water in a hot cooking compartment may create hot steam. Never pour water into the cooking compartment when the cooking compartment is hot.

⚠ Warning – Risk of injury!

- Scratched glass in the appliance door may develop into a crack. Do not use a glass scraper, sharp or abrasive cleaning aids or detergents.
- Saucepans may suddenly jump due to liquid between the pan base and the hotplate. Always keep the hotplate and saucepan bases dry.
- If the appliance is placed on a base and is not secured, it may slide off the base. The appliance must be fixed to the base.
- The hinges on the appliance door move when opening and closing the door, and you may be trapped. Keep your hands away from the hinges.

- If you leave the appliance door open, people may bump into it, resulting in injury. The appliance door must be kept closed both while the appliance is in operation and when it has finished.

⚠ Warning – Risk of tipping!

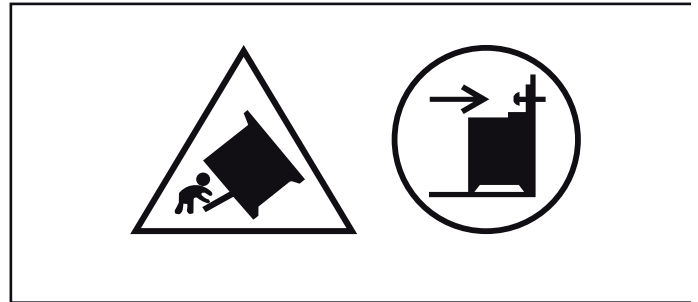

Warning: In order to prevent tipping of the appliance, this stabilizing means must be installed. Refer to the instructions for installation.

⚠ Warning – Risk of electric shock!

- Incorrect repairs are dangerous. Repairs may only be carried out by one of our trained after-sales engineers. If the appliance is faulty, unplug the mains plug or switch off the fuse in the fuse box. Contact the after-sales service.
- The cable insulation on electrical appliances may melt when touching hot parts of the appliance. Never bring electrical appliance cables into contact with hot parts of the appliance.
- Do not use any high-pressure cleaners or steam cleaners, which can result in an electric shock.
- A defective appliance may cause electric shock. Never switch on a defective appliance. Unplug the appliance from the mains or switch off the circuit breaker in the fuse box. Contact the after-sales service.
- Cracks or fractures in the glass ceramic may cause electric shocks. Switch off the circuit breaker in the fuse box. Contact the after-sales service.

Halogen lamp

⚠ Warning – Risk of burns!

The bulbs in the cooking compartment become very hot. There is still a risk of burning your skin for some time after they have been switched off. Do not touch the glass cover. Avoid contact with your skin when cleaning.

⚠ Warning – Risk of electric shock!

When replacing the cooking compartment bulb, the bulb socket contacts are live. Before replacing the bulb, unplug the appliance from the mains or switch off the circuit breaker in the fuse box.

➔ Causes of damage

Hob

Caution!

- Rough pot and pan bases scratch the ceramic.
- Avoid boiling pots dry. This may cause damage.
- Never place hot pots or pans on the control panel, the display area or the surround. This may cause damage.
- Damage can occur if hard or pointed objects fall on the hob.
- Aluminium foil and plastic containers melt on hot hotplates. Oven protective foil is not suitable for your hob.

Overview

The following table provides an overview of the most frequent kinds of damage:

Damage	Cause	Action
Stains	Food spills	Remove spills immediately with a glass scraper.
	Unsuitable cleaning agents	Only use cleaning agents which are suitable for ceramic
Scratches	Salt, sugar and sand	Do not use the hob as a work surface or storage space.
	Rough pot and pan bases scratch the ceramic.	Check your cookware.
Discolouration	Unsuitable cleaning agents	Only use cleaning agents which are suitable for ceramic
	Pan abrasion (e.g. aluminium)	Lift the pots and pans when moving them.
Blisters	Sugar, food with a high sugar content	Remove spills immediately with a glass scraper.

Damage to the oven

Caution!

- Accessories, foil, greaseproof paper or ovenware on the cooking compartment floor: do not place accessories on the cooking compartment floor. Do not cover the cooking compartment floor with any sort of foil or greaseproof paper. Do not place ovenware on the cooking compartment floor if a temperature of over 50 °C has been set. This will cause heat to accumulate. The baking and roasting times will no longer be correct and the enamel will be damaged.
- Aluminium foil: Aluminium foil in the cooking compartment must not come into contact with the door glass. This could cause permanent discolouration of the door glass.
- Water in a hot cooking compartment: do not pour water into the cooking compartment when it is hot. This will cause steam. The temperature change can cause damage to the enamel.
- Moisture in the cooking compartment: Over an extended period of time, moisture in the cooking compartment may lead to corrosion. Allow the cooking compartment to dry after use. Do not keep moist food in the closed cooking compartment for extended periods of time. Do not store food in the cooking compartment.

- Cooling with the appliance door open: Following operation at high temperatures, only allow the cooking compartment to cool down with the door closed. Do not trap anything in the appliance door. Even if the door is only left open a crack, the front of nearby furniture may become damaged over time. Only leave the cooking compartment to dry with the door open if a lot of moisture was produced whilst the oven was operating.
- Fruit juice: when baking particularly juicy fruit pies, do not pack the baking tray too generously. Fruit juice dripping from the baking tray leaves stains that cannot be removed. If possible, use the deeper universal pan.
- Extremely dirty seal: If the seal is very dirty, the appliance door will no longer close properly during operation. The fronts of adjacent units could be damaged. Always keep the seal clean. Never operate the appliance if the seal is damaged or missing. → "Cleaning" on page 17
- Appliance door as a seat, shelf or worktop: Do not sit on the appliance door, or place or hang anything on it. Do not place any cookware or accessories on the appliance door.
- Inserting accessories: depending on the appliance model, accessories can scratch the door panel when closing the appliance door. Always insert the accessories into the cooking compartment as far as they will go.

- Carrying the appliance: do not carry or hold the appliance by the door handle. The door handle cannot support the weight of the appliance and could break.
- Grilling: do not insert the baking tray or universal pan higher than level 3 when grilling. The high heat distorts it and the enamel may be damaged when it is removed. At level 4 and 5, only grill directly on the wire rack.

Damage to the plinth drawer

Caution!

Do not place hot objects in the plinth drawer. It could be damaged.

Environmental protection

Your new appliance is particularly energy-efficient. Here you can find tips on how to save even more energy when using the appliance, and how to dispose of your appliance properly.

Saving energy

- Only preheat the appliance if this is specified in the recipe or in the tables in the operating instructions.
- Leave frozen food to defrost before placing it in the cooking compartment.

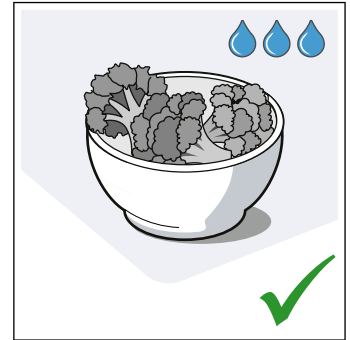
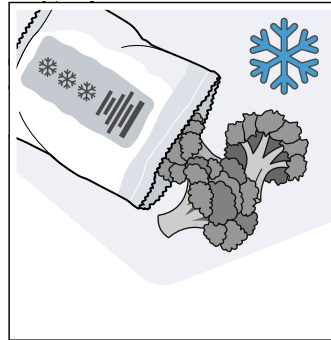

- Use baking tins that are dark-coloured, painted black or have an enamel coating. These absorb the heat particularly well.

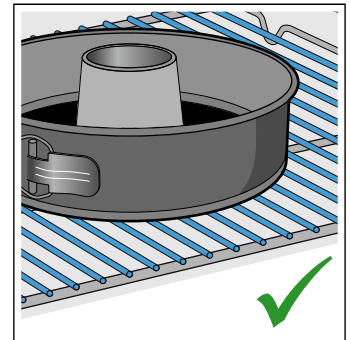
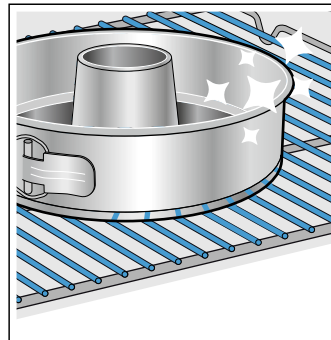

- Remove any unnecessary accessories from the cooking compartment.

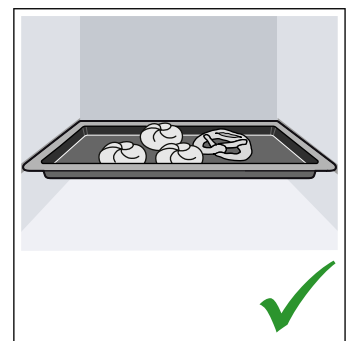
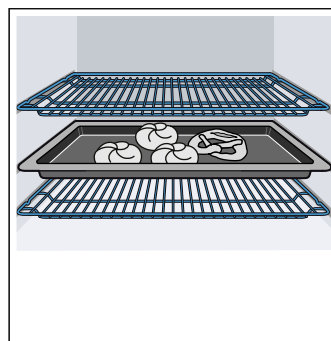

- Open the appliance door as infrequently as possible when the appliance is in use.

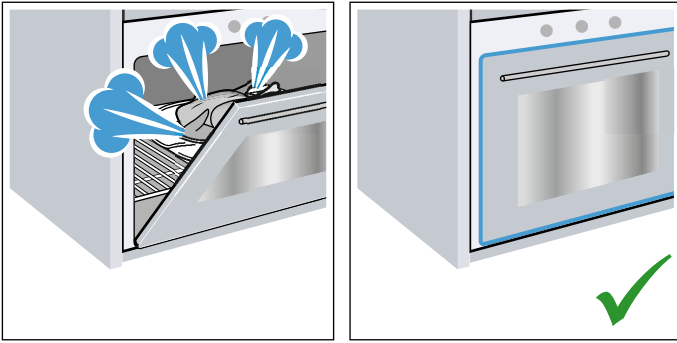

- It is best to bake several cakes one after the other. The cooking compartment stays warm. This reduces the baking time for the second cake. You can place two cake tins next to each other in the cooking compartment.



- For longer cooking times, you can switch the appliance off 10 minutes before the end of the cooking time and use the residual heat to finish cooking.

Saving energy with the hob

- Use pots and pans with thick, even bases. Uneven bases increase energy consumption.
- The diameter of pan bases should be the same size as the hotplate. In particular, small saucepans on the hotplate cause energy losses. Note that cookware manufacturers often indicate the upper diameter of the saucepan. This is usually bigger than the diameter of the base of the pan.
- Use a small saucepan for small quantities. A larger, less full saucepan requires a lot of energy.
- Always place suitable lids on saucepans. When cooking without a lid, four times the energy is required.
- Cook with only a little water. This will save energy. Vitamins and minerals in vegetables are preserved.
- Switch to a lower heat setting in good time.
- Use the residual heat. For longer cooking times, you can switch the hotplate off 5-10 minutes before the end of the cooking time.

Environmentally-friendly disposal

Dispose of packaging in an environmentally-friendly manner.



This appliance is labelled in accordance with European Directive 2012/19/EU concerning used electrical and electronic appliances (waste electrical and electronic equipment - WEEE). The guideline determines the framework for the return and recycling of used appliances as applicable throughout the EU.

Installation and connection

Do not install the appliance behind a decorative door or the door of a kitchen unit, as this may cause the appliance to overheat.

Electrical connection

Only licensed specialists may connect the appliance. It is important that you comply with the requirements of your electricity supplier.

Any damage arising from the appliance being connected incorrectly will invalidate the warranty.

Caution!

If the supply cord is damaged, it must be replaced by the manufacturer, its service agent or similarly qualified persons in order to avoid a hazard.

Warning – Danger of death!

There is a risk of electric shock if you touch live components.

- Always make sure your hands are dry when you touch or hold the mains plug.
- Only pull out the mains cable by taking hold of the plug and removing the plug; never pull it out by the mains cable itself, as this could damage it.
- Never unplug the mains plug when the appliance is in operation.

Please note the following information and ensure that:

Notes

- The mains plug fits the socket.
- The cable cross section is adequate.
- The earthing system is properly installed.
- The mains cable is only replaced by a qualified electrician (if this is necessary). Spare mains cables can be ordered from our after-sales service.
- No power strips/multi-way connectors or extension cables are used.
- If using a residual current device, only use one that bears the mark . The presence of this mark is the only way to be sure that it fulfils all the applicable regulations.
- The mains plug can be accessed at all times.
- The mains cable is not kinked, crushed, modified or severed.
- The mains cable does not come into contact with heat sources.

For the installer

- An all-pole isolating switch with a contact gap of at least 3 mm must be present in the installation circuit. This is not necessary if the appliance is connected by a plug that is accessible to the user.
- Electrical safety: The cooker corresponds to safety class I and may only be used in conjunction with a safety earth terminal.
- A type H 05 VV-F or equally rated lead must be used to connect the appliance.

Adjacent units

Any adjacent units must not be made of flammable materials. The fronts of any adjacent units must be heat-resistant up to at least 90 °C.

Wall fixing

To prevent the cooker from tipping over, you must fix it to the wall using the enclosed bracket. Please observe the installation instructions for fixing the oven to the wall.

Door lock

To prevent children reaching into the oven when it is hot, the oven door is equipped with a lock. It is located at the top of the oven door.

Opening the oven door

Press the lock upwards (picture A).

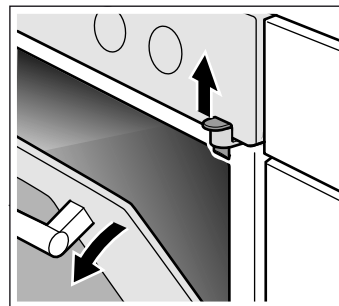

Removing the door lock

If the door safety lock is no longer needed or if it is soiled:

1. Opening the oven door
2. Unscrew the screw and remove the door lock (picture B).

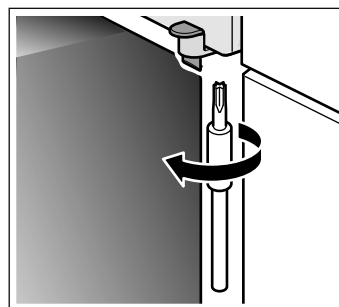

3. Close the oven door.

Measures to be noted during transport

Secure all mobile parts in and on the appliance using an adhesive tape that can be removed without leaving any traces. Push all accessories (e.g. baking tray) into the corresponding slots with cardboard at the edges, in order to avoid damaging the appliance. Place cardboard or similar between the front and rear side to prevent knocks against the inside of the glass door. Secure the door and, if available, the top cover to the appliance sides using adhesive tape.

Keep the original appliance packaging. Only transport the appliance in the original packaging. Observe the transport arrows on the packaging.

If the original packaging is no longer available

pack the appliance in protective packaging to guarantee sufficient protection against any transport damage.

Transport the appliance in an upright position. Do not hold the appliance by the door handle or the connections on the rear, as these could be damaged. Do not place any heavy objects on the appliance.

General information

The design depends on the respective appliance model.

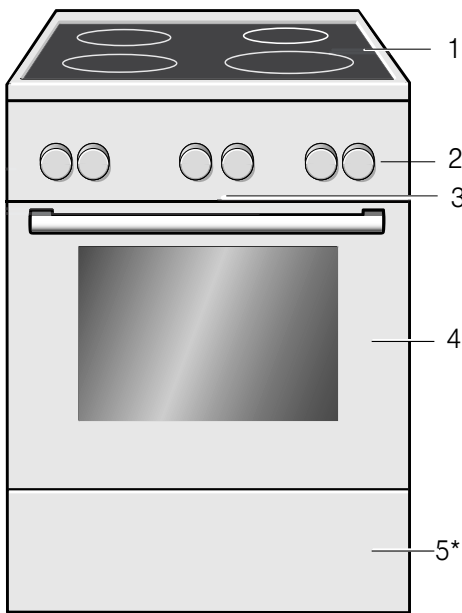

Explanations	
1	Hob**
2	Control panel**
3*	Cooling fan
4	Oven door**
5*	Plinth drawer**
* Optional (available for some appliances)	
** Details may vary depending on the appliance model.	

Getting to know your appliance

In this section, we will explain the indicators and controls. You will also find out about the various functions of your appliance.

Note: Depending on the appliance model, individual details and colours may differ.

Cooking area

Here is an overview of the control panel. The design depends on the respective appliance model.

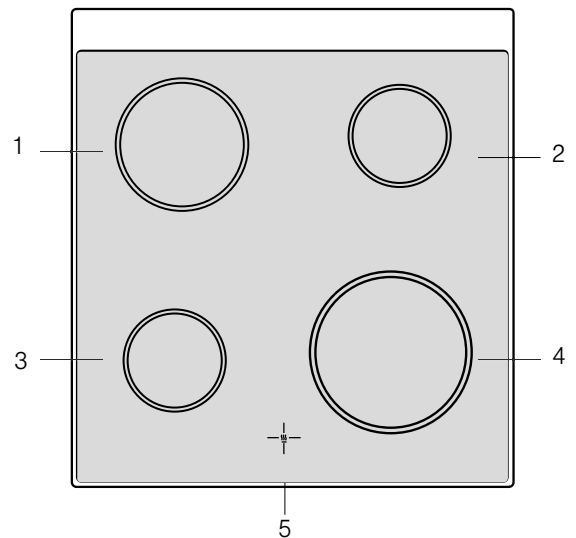

Explanations	
1	Hotplate 18 cm
2	Hotplate 14.5 cm
3	Hotplate 14.5 cm
4	Hotplate 21 cm
5	Residual heat indicator

Residual heat indicator

The hob has a residual heat indicator for each hotplate. It shows which hotplates are still hot. Even if the hob is switched off, the display remains lit until the hotplate has cooled down sufficiently.

You can save energy by using the residual heat to keep a small dish warm, for example.





Control panel

Details may vary depending on the appliance model.

Types of heating and functions



Use the function selector to set the types of heating and other functions.

To make sure you always use the right type of heating to cook your food, we have explained the differences and applications below.

Type of heating		Use
	Top/bottom heating	For traditional baking and roasting on one level. Especially suitable for cakes with moist toppings. Heat is emitted evenly from above and below. This type of heating is used to measure the energy consumption in the conventional mode.
	Gentle top/bottom heating	For gently cooking selected types of food. Heat is emitted from above and below. This type of heating is used to measure the energy consumption in the conventional mode.
	Bottom heating	For cooking in a bain marie and for baking food for extra time. Heat is emitted from below.
	Centre-area grill	This heating function is suitable for grilling small amounts of steak, sausages, fish and bread. The centre part of the grill heating element becomes hot.
	Grill, large area	For grilling flat items, such as steaks or sausages, for making toast, and for browning food. The whole area below the grill element becomes hot.

Other functions



Your new oven has yet more functions; see below for a brief description of these.

Function		Use
	Interior lighting	Switches on the interior lighting; all other functions remain off. Makes it easier to clean the cooking compartment, for example.
	Childproof lock	Switch off the power supply for the oven and hob functions on the control panel. After activation, the appliance cannot be switched on.

Temperature

Use the temperature selector to set the temperature in the cooking compartment. You can also use it to select the settings for other functions.

For temperature settings above 250 °C, the appliance reduces the temperature to approx. 240 °C after approx. 10 minutes. If your appliance has the top/bottom heating or bottom heating types, this reduction does not take place.

Position		Meaning
●	"Off" position	The appliance is not heating.
50-275	Temperature range	The temperature that can be set in the cooking compartment in °C.
1, 2, 3 or I, II, III	Grill settings	The configurable settings for the grill, large area  and small area  (depending on the appliance model). Setting 1 = low Setting 2 = medium Setting 3 = high

Temperature display

When the appliance is heating, the indicator lamp above the temperature selector is lit. It goes out during pauses in the heating.

When you are preheating the appliance, the optimal time to place your food in the cooking compartment is when the indicator lamp first goes out.

Note: Due to thermal inertia, the temperature displayed may be slightly different to the actual temperature inside the oven.

Hotplate controls

You can use the four hotplate controls to control the heat output provided by each hotplate.

Setting		Meaning
0	Off position	The hotplate is switched off.
1-9	Heat settings	1 = lowest output 9 = highest output

When you switch on a hotplate, the indicator lamp lights up.

Cooking compartment

Various functions in the cooking compartment make your appliance easier to use. For example, the cooking compartment is well lit and a cooling fan prevents the appliance from overheating.

Opening the appliance door

If you open the appliance door when the appliance is in operation, the appliance will continue to operate as before.

Interior lighting

With most heating functions and other functions, the interior lighting in the cooking compartment will remain lit while the oven is in operation. When the function selector is turned to bring operation to an end, the lighting will go out.

By turning the function selector to the interior lighting setting, you can switch on the lighting without heating the oven. This makes it easier to clean your appliance, for example.

Cooling fan

The cooling fan switches on and off as required. The hot air escapes above the door.

Caution!

Do not cover the ventilation slots. Otherwise, the appliance may overheat.

So that the cooking compartment cools down more quickly after operation, the cooling fan continues to run for a certain period afterwards.

Accessories

Your appliance is accompanied by a range of accessories. Here, you can find an overview of the accessories included and information on how to use them correctly.

Accessories included

Your appliance is equipped with the following accessories:

	<p>Wire rack For ovenware, cake tins and ovenproof dishes. For roasts, grilled items and frozen meals.</p>
	<p>Universal pan For moist cakes, pastries, frozen meals and large roasts. It can be used to catch dripping fat when you are grilling directly on the wire rack.</p>
	<p>Baking tray For tray bakes and small baked products.</p>

Only use genuine accessories. They are specially adapted for your appliance.

You can buy accessories from the after-sales service, from specialist retailers or online.

Note: The accessories may become deformed when they become hot. This does not affect their function. Once they cool down again, they regain their original shape.

Inserting accessories

The cooking compartment has five shelf positions. The shelf positions are counted from the bottom up.

In some appliances, the highest shelf position is marked on the cooking compartment by the grill symbol.

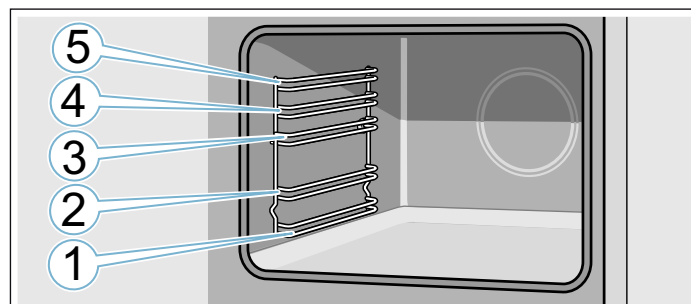

Always insert accessories between the two guide rods for the shelf position.

Accessories can be pulled out approximately halfway without tipping.

When sliding accessories into the cooking compartment, ensure that the kink in the side rail is at the back. Only then will they lock in place.

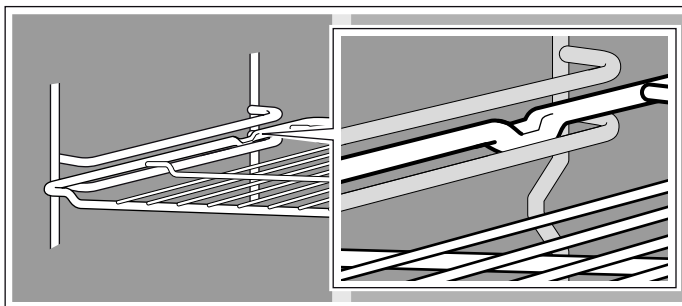

Notes

- Hold the baking tray securely at the sides with both hands and slide it into the shelf supports, keeping it parallel. Do not move the baking tray from side to side as you slide it in, otherwise it will not go in easily and the enamelled surfaces may be damaged.
- Make sure that you always insert the accessories into the cooking compartment the right way round.
- Always insert the accessories fully into the cooking compartment so that they do not touch the appliance door.
- Take any accessories that you will not be using out of the cooking compartment.

Optional accessories

You can buy optional accessories from our after-sales service, from specialist retailers or online. You will find a comprehensive range of products for your appliance in our brochures and online.

Their availability and whether it is possible to order them online varies from country to country. See your sales brochures for more details.

Note: Not all optional accessories are suitable for every appliance. When purchasing, always quote the exact product number (E no.) of your appliance.

→ "Customer service" on page 23

Optional accessories

Wire rack

For cookware, cake tins and ovenproof dishes, and for roasts and grilled food.

Baking tray

For tray bakes and small baked items.

Universal pan

For moist cakes, baked items, frozen food and large roasts.

It can be used to catch dripping fat when you are grilling directly on the wire rack.

Wire insert

For meat, poultry and fish.

For inserting into the universal pan to catch dripping fat and meat juices.

Professional pan

For preparing large quantities of food. Also ideal for moussaka, for example.

Lid for the professional pan

The lid turns the professional pan into a professional roasting dish.

Pizza tray

For pizzas and large round cakes.

Grill tray

Use for grilling in place of the wire rack or as a splatter guard. Use in the universal pan only.

Baking stone

For home-made bread, bread rolls and pizzas that you wish to have a crispy base.

The baking stone must be preheated to the recommended temperature.

Glass roasting dish

For stews and bakes.

Glass pan

For bakes, vegetable dishes and baked items.

Pull-out system, one level

Fitting pull-out rails at position 2 will allow you to pull accessories out further without them tipping.

Pull-out system, two levels

Fitting pull-out rails at positions 2 and 3 will allow you to pull accessories out further without them tipping.

Pull-out system, three levels

Fitting pull-out rails at positions 1, 2 and 3 will allow you to pull accessories out further without them tipping.



Before using for the first time

Before you can use your new appliance, you must make some settings. You must also clean the cooking compartment and accessories.

Cleaning the cooking compartment and accessories

Before using the appliance to prepare food for the first time, you must clean the cooking compartment and accessories.

Cleaning the cooking compartment

To remove the new-appliance smell, heat up the cooking compartment when empty and with the oven door closed.

Make sure that the cooking compartment does not contain any leftover packaging, such as polystyrene pellets. Before heating the appliance, wipe the smooth surfaces in the cooking compartment with a soft, wet cloth. Keep the kitchen ventilated while the appliance is heating.

Make the settings indicated. You can find out how to set the type of heating and the temperature in the next section. → "Operating the appliance" on page 16

Settings	
Heating function	Top/bottom heating <input type="checkbox"/>
Temperature	maximum
Duration	One hour

Switch off the appliance after the cooking time indicated.

After the cooking compartment has cooled down, clean the smooth surfaces with soapy water and a dish cloth.

Cleaning the accessories

Clean the accessories thoroughly using soapy water and a dish cloth or soft brush.



Setting the cooking time

This chapter explains how to set a hotplate. The table shows heat settings and cooking times for various meals.

Setting procedure

Adjust the heat setting of the individual hotplates using the hotplate controls.

Position 0 = off

Position 1 = lowest heat setting

Position 9 = highest heat setting

When you switch on a hotplate, the indicator lamp lights up.

Table of cooking times

The following table provides some examples.

Cooking times and heat settings may vary depending on the type of food, its weight and quality. Deviations are therefore possible.

	Ongoing cooking setting	Ongoing cooking time in minutes
Melting		
Chocolate, cooking chocolate, gelatine	1	-
Butter	1-2	-
Heating and keeping warm		
Stew (e.g. lentil stew)	1-2	-
Milk**	1-2	-
Poaching, simmering		
Dumplings	4*	20-30 mins
Fish	3*	10-15 mins
White sauces, e.g. béchamel sauce	1	3-6 mins
* Continue cooking without a lid		
** Without lid		

	Ongoing cooking setting	Ongoing cooking time in minutes
Boiling, steaming, stewing		
Rice (with double the quantity of water)	3	15-30 mins
Unpeeled boiled potatoes	3-4	25-30 mins
Boiled potatoes	3-4	15-25 mins
Pasta, noodles	5*	6-10 mins
Stew, soups	3-4	15-60 mins
Vegetables	3-4	10-20 mins
Vegetables, frozen	3-4	10-20 mins
Cooking in a pressure cooker	3-4	-
Braising		
Roulades	3-4	50-60 mins
Pot roasts	3-4	60-100 mins
Goulash	3-4	50-60 mins
Frying**		
Escalope, plain or breaded	6-7	6-10 mins
Escalope, frozen	6-7	8-12 mins
Steak (3 cm thick)	7-8	8-12 mins
Fish and fish fillet, plain	4-5	8-20 mins
Fish and fish fillet, breaded	4-5	8-20 mins
Fish and fish fillet, breaded and frozen, e.g. fish fingers	6-7	8-12 mins
Stir fry, frozen	6-7	6-10 mins
Pancakes	5-6	continuous
* Continue cooking without a lid		
** Without lid		

Operating the appliance

You have already learnt about the controls and how they work. Now we will explain how to apply settings on your appliance.

Switching the appliance on and off

Use the function selector to switch the appliance on or off. Turning the function selector to any position other than the "Off" position switches on the appliance. To switch off the appliance, always turn the function selector to the "Off" position.

Setting the type of heating and temperature

It is very easy to apply the settings you require to your appliance using the function and temperature selector. To find out which heating function is best for which type of food, refer to the beginning of the instruction manual.

Example in the picture: Top/bottom heating  at 190 °C.

1. Use the function selector to set the heating function.

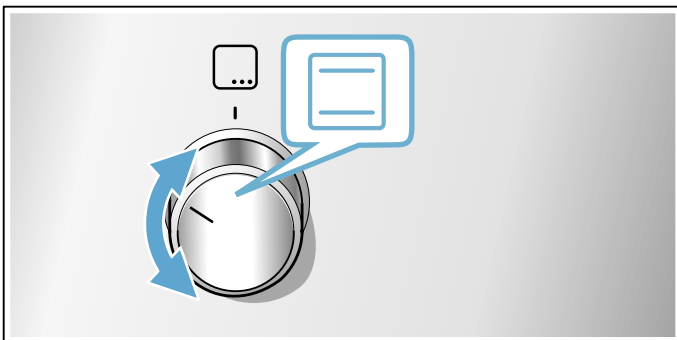

2. Use the temperature selector to set the temperature or grill setting.

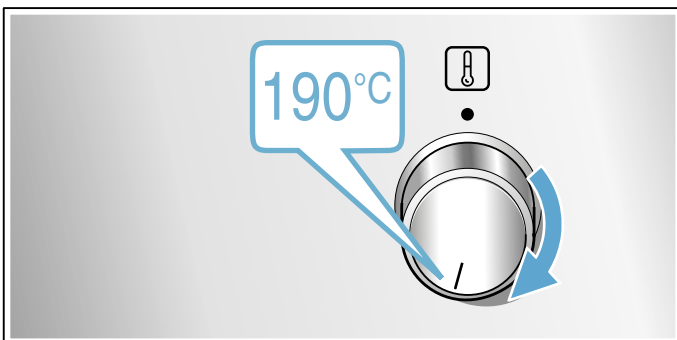

The appliance starts to heat up after a few seconds.

Once the food is cooked, turn the function selector to the "Off" position to switch the appliance off.

Changing

The heating function and temperature can be changed at any time using the relevant selector.

Childproof lock

Your appliance is equipped with a childproof lock so that children cannot switch it on accidentally or change any settings.

Note: If the childproof lock is activated during operation, the power supply to the appliance is interrupted. The appliance is blocked. For the initial use of the appliance, the blockage must be eliminated.

Activating and deactivating

To activate the childproof lock, turn the function selector to the  position.

The power supply to the oven and hob is interrupted. The appliance is blocked.

To deactivate, press the function selector and turn it to the off position. The blockage is eliminated.

Cleaning

With good care and cleaning, your appliance will retain its appearance and remain fully functioning for a long time to come. We will explain here how you should correctly care for and clean your appliance.

Cleaning agents

Damage to the various different surfaces caused by using the wrong cleaning agent can be avoided by observing the following instructions.

When cleaning the hob do not use

- undiluted washing-up liquid or dishwasher detergent,
- scouring pads,
- abrasive cleaning agents such as oven cleaner or stain remover,
- high-pressure cleaners or steam jets.
- Do not clean individual parts in the dishwasher.

When cleaning the oven do not use

- sharp or abrasive cleaning agents,
- cleaning agent with a high alcohol content,
- scouring pads,
- high-pressure cleaners or steam jets.
- Do not clean individual parts in the dishwasher.

Wash new sponges thoroughly before first use.

Warning – Risk of burns!

The appliance becomes very hot. Never touch the interior surfaces of the cooking compartment or the heating elements. Always allow the appliance to cool down. Keep children at a safe distance.

Zone	Cleaning agent
Stainless steel surfaces* (depending on appliance model)	Hot soapy water: Clean with a dish cloth and dry with a soft cloth. On stainless steel surfaces, always wipe parallel to the natural grain. Otherwise, you may scratch the surface. Remove patches and splashes of limescale, grease, starch and albumin (e.g. egg white) immediately. Corrosion can form under such patches and splashes. Special care products suitable for hot stainless steel surfaces are available from our after-sales service and from specialist retailers. Apply a thin layer of care product with a soft cloth.
Enamel, painted, plastic and screen-printed surfaces* (depending on appliance model)	Hot soapy water: Clean with a dish cloth and dry with a soft cloth. Do not use glass cleaner or glass scrapers for cleaning.
Control panel	Hot soapy water: Clean with a dish cloth and dry with a soft cloth. Do not use glass cleaner or glass scrapers for cleaning.

* Optional (available for some appliances, depending on the appliance model)

Zone	Cleaning agent
Upper glass cover* (depending on appliance model)	Glass cleaner: Clean with a soft cloth. You can remove the upper glass cover for cleaning. To find out how to do this, please refer to the section <i>Upper glass cover</i> .
Rotary knobs Do not remove.	Hot soapy water: Clean with a dish cloth and dry with a soft cloth.
Hob surround	Hot soapy water: Do not clean with a glass scraper, lemon juice or vinegar.
Gas hob and pan supports* (depending on appliance model)	Hot soapy water. Use very little water. Water must not be allowed to enter the appliance through the base of the burners. Clean off boiled-over liquids and spilt food immediately. You can remove the pan supports. Cast iron pan supports*: Do not clean in the dishwasher.
Gas burners* (depending on appliance model)	Remove the burner head and cap and clean with hot soapy water. Do not clean in the dishwasher. The gas outlet openings must remain unobstructed at all times. Ignition plugs: Small, soft brush. The gas burners only work properly when the ignition plugs are dry. Dry all parts thoroughly. Ensure that they are refitted correctly. The burner caps are coated in black enamel. The colour may change over time. This does not impair their performance.
Electric hotplate* (depending on appliance model)	Abrasive materials or sponges: Briefly heat up the hotplate afterwards, so that it dries. Hotplates can rust over time if they remain wet. Apply care product to finish. Clean off boiled-over liquids and spilt food immediately.
Hotplate ring* (depending on appliance model)	Remove yellow to blue iridescent discolouration from the hotplate ring with a steel care product. Do not use any abrasive materials that may scratch surfaces.
Ceramic hob* (depending on appliance model)	Care: Protective/care products for ceramics Cleaning: Cleaning agents suitable for ceramics. Follow the cleaning instructions on the packaging.  Glass scraper for stubborn dirt: Remove the protective cover and clean using the blade only. Caution: The blade is very sharp. Risk of injury. Cover the blade again after cleaning. Replace damaged blades immediately.

* Optional (available for some appliances, depending on the appliance model)

Zone	Cleaning agent
Glass hob* (depending on appliance model)	Care: Protective/care products for glass Cleaning: Cleaning agents for glass. Follow the cleaning instructions on the packaging. ⚠ Glass scraper for stubborn dirt: Remove the protective cover and clean using the blade only. Caution: The blade is very sharp. Risk of injury. Cover the blade again after cleaning. Replace damaged blades immediately.
Glass panel	Glass cleaner: Clean with a soft cloth. Do not use the glass scraper. The door can be removed to facilitate cleaning. To find out how to do this, please refer to the section Removing and refitting the oven door .
Childproof lock* (depending on appliance model)	Hot soapy water: Clean with a dish cloth. If a childproof lock has been fitted to the oven door, it must be removed before cleaning. If it is very dirty, the childproof lock will not work properly.
Seal Do not remove.	Hot soapy water: Clean with a dish cloth. Do not scour.
Cooking zone	Hot soapy water or a vinegar solution: Clean with a dish cloth. For stubborn dirt, use a stainless steel scouring pad or oven cleaner. Only use when the cooking compartment is cold. ⚠ Please use the self-cleaning function to clean self-cleaning surfaces. To find out how to do this, please refer to the section Self-cleaning . Caution! Never use oven cleaner on self-cleaning surfaces.
Glass cover for the oven light	Hot soapy water: Clean with a dish cloth.
Shelf	Hot soapy water: Clean with a dish cloth or a brush. You can remove the shelves for cleaning. To find out how to do this, please refer to the section Removing and refitting shelves . Telescoping extension rails* (depending on appliance model) Hot soapy water: Clean with a dish cloth or a brush. Do not remove the lubricant from the extension rails. It is best to clean them when they are pushed in. Do not soak, clean in the dishwasher, or clean in the oven as part of the self-cleaning programme. This may damage the shelves and they may no longer work properly as a result.

* Optional (available for some appliances, depending on the appliance model)

Zone	Cleaning agent
Accessories	Hot soapy water: Soak and then clean with a dish cloth or a brush. Aluminium baking tray*: (depending on appliance model) Dry with a soft cloth. Do not clean in the dishwasher. Never use oven cleaner. To prevent scratches, never touch the metal surfaces with a knife or a similar sharp object. Harsh cleaning products, scratchy sponges and rough cleaning cloths are not suitable. Otherwise, you may scratch the surface. Rotary spit* (depending on appliance model) Hot soapy water: Clean with a dish cloth or a brush. Do not clean in the dishwasher. Meat thermometer* (depending on appliance model) Hot soapy water: Clean with a dish cloth or a brush. Do not clean in the dishwasher.
Plinth drawer* (depending on appliance model)	Hot soapy water: Clean with a dish cloth.

* Optional (available for some appliances, depending on the appliance model)

Notes

- Slight differences in colour on the front of the appliance are caused by the use of different materials, such as glass, plastic and metal.
- Shadows on the door panels, which look like streaks, are caused by reflections made by the interior lighting.
- Enamel is baked on at very high temperatures. This can cause some slight colour variation. This is normal and does not affect operation. The edges of thin trays cannot be completely enamelled. As a result, these edges can be rough. This does not impair the anti-corrosion protection.

Keeping the appliance clean

Always keep the appliance clean and remove dirt immediately so that stubborn deposits of dirt do not build up.

Warning – Risk of fire!

Loose food remnants, fat and meat juices may catch fire. Before using the appliance, remove the worst of the food remnants from the cooking compartment, heating elements and accessories.

Tips

- Clean the cooking compartment after each use. This will ensure that dirt cannot be baked on.
- Always remove flecks of limescale, grease, starch and albumin (e.g. egg white) immediately.
- Use the universal pan for baking very moist cakes.
- Use suitable ovenware for roasting, e.g. a roasting dish.

Rails

With good care and cleaning, your appliance will retain its appearance and remain fully functional for a long time to come. This will tell you how to remove the shelves and clean them.

Detaching and refitting the rails

The rails can be removed for cleaning. The oven must have cooled down.

Unhooking the rails

1. Hold the shelf frames from underneath and pull slightly forward. Pull the extension pins at the bottom of the rails out of the mounting holes (Fig. A).
2. Then fold the rails upwards and carefully remove them (Fig. B).

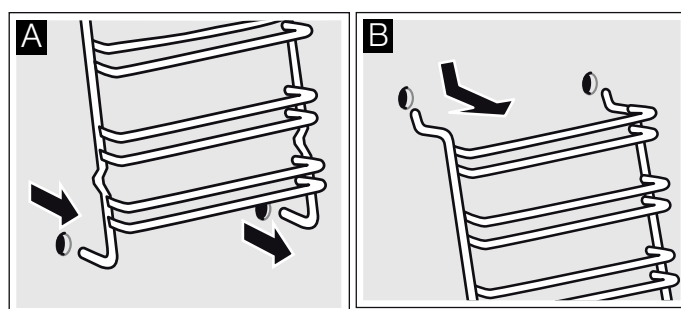

Clean the rails with washing-up liquid and a sponge. For stubborn deposits of dirt, use a brush.

Installing the frames

1. Insert the two hooks carefully into the upper holes. (Figure A-B)

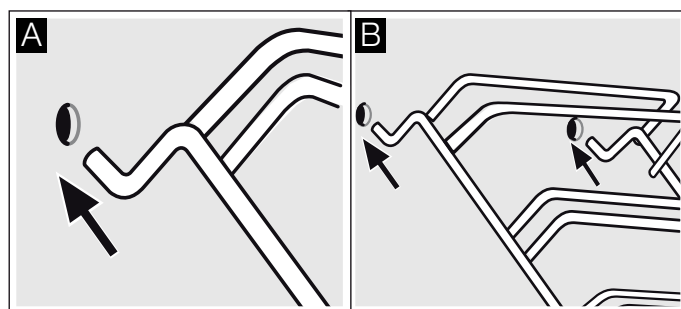

Warning

Incorrect assembly!

Never move the frame before the two hooks are fully anchored in the upper holes. The enamel could be damaged and may break (figure C).

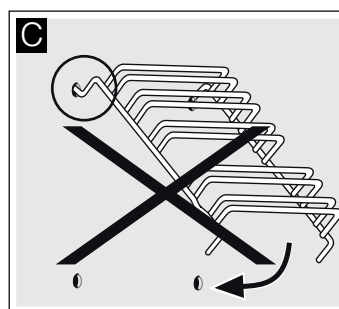

2. the two hooks must be inserted fully into the upper holes. Now move the frame slowly and carefully downwards and insert in the lower holes (figure D).
3. Insert both frames into the side walls of the oven (figure E).

If the rails are fitted correctly, the distance between the two upper shelf positions is greater.

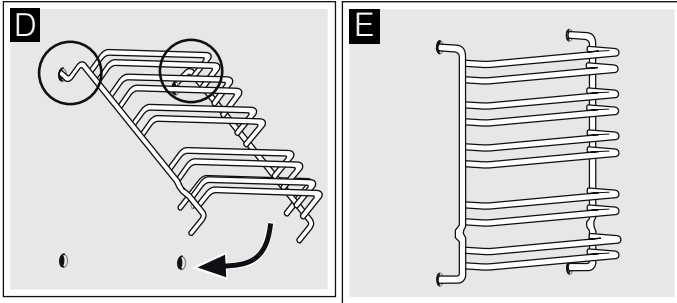

Appliance door

With good care and cleaning, your appliance will retain its appearance and remain fully functional for a long time to come. This will tell you how to remove the appliance door and clean it.

Detaching and attaching the oven door

For cleaning purposes and to remove the door panels, you can detach the oven door.

The oven door hinges each have a locking lever. When the locking levers are closed (figure A), the oven door is secured in place. It cannot be detached. When the locking levers are open in order to detach the oven door (Fig. B), the hinges are locked. They cannot snap shut.

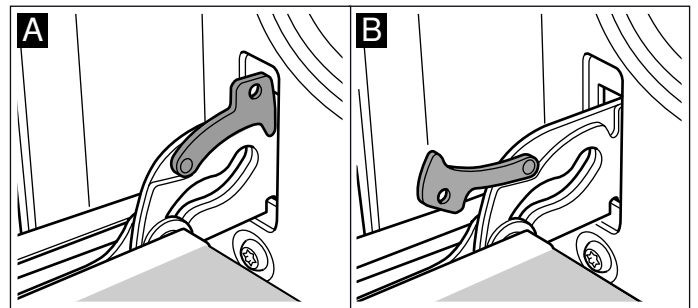

Warning – Risk of injury!

Whenever the hinges are not locked, they snap shut with great force. Ensure that the locking levers are always fully closed or, when detaching the oven door, fully open.

Detaching the door

1. Open the oven door fully.
2. Fold up the two locking levers on the left and right (figure A).
3. Close the oven door as far as the limit stop. With both hands, grip the door on the left and right-hand sides. Close the door a little further and pull it out (figure B).

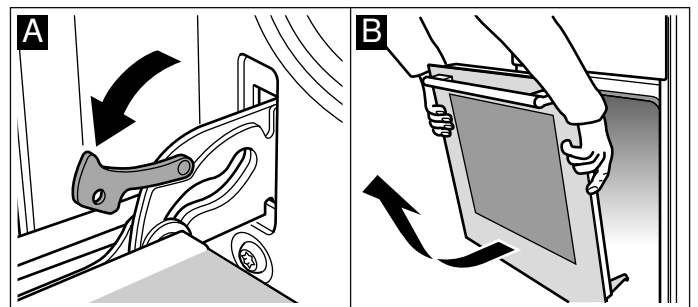

Attaching the door

Reattach the oven door in the reverse sequence to removal.

1. When attaching the oven door, ensure that both hinges are inserted straight into the opening (figure A).
2. The notch on the hinge must engage on both sides (figure B).

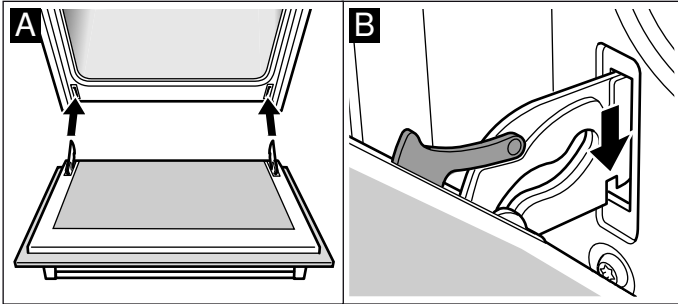

3. Fold back both locking levers (figure C). Close the oven door.

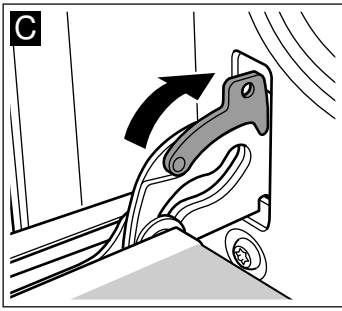

⚠ Warning – Risk of injury!

If the oven door falls out accidentally or a hinge snaps shut, do not reach into the hinge. Call the after-sales service.

Removing and installing the door panels

To facilitate cleaning, you can remove the glass panels from the oven door.

Removal

1. Detach the oven door and lay it on a cloth with the handle facing down.
2. Pull off the cover at the top of the oven door. Press in the tabs on the left and right using your fingers (fig. A).
3. Lift the top panel up and pull it out (fig. B).

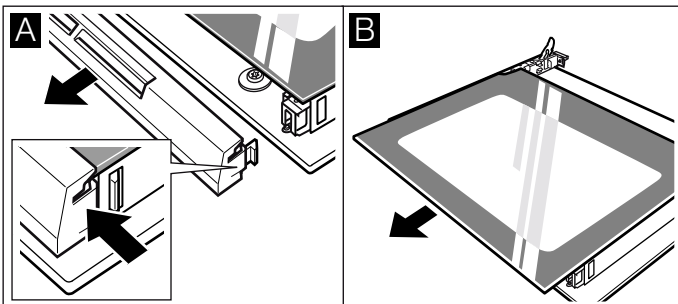

4. Lift the panel up and pull it out (fig. C).

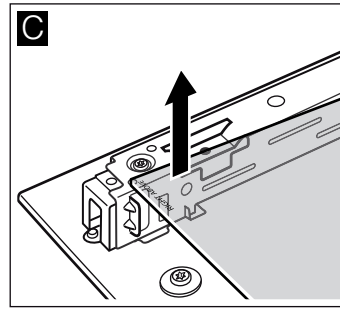

Clean the panels with glass cleaner and a soft cloth.

⚠ Warning – Risk of injury!

Scratched glass in the appliance door may develop into a crack. Do not use a glass scraper, sharp or abrasive cleaning aids or detergents.

Installation

During installation, make sure that the lettering "top right" is upside down at the bottom left.

1. Insert the panel at an angle towards the back (fig. A).
2. Insert the top panel at an angle towards the back into the brackets. The smooth surface must face outwards. (fig. B).

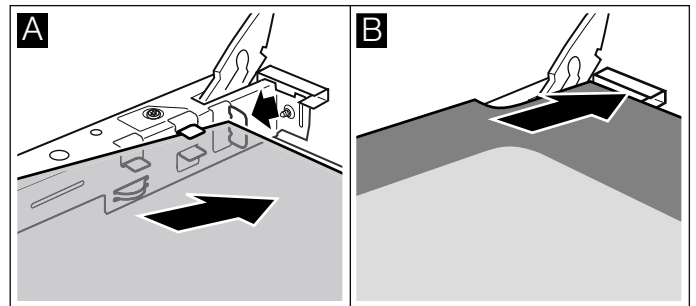

3. Put the cover back in place and press on it.
4. Attach the oven door.

Do not use the oven again until the panels have been correctly installed.

Additional door safety

When preparing meals with long cooking times, the oven door can reach very high temperatures.

Supervise small children and keep them away from the oven when the oven is in operation.

Additional safety devices have been fitted to prevent contact with the oven door. Always attach these safety devices when children could come near the oven.

You can purchase this optional accessory (11023590) from the after-sales service.

Trouble shooting

If a fault occurs, there is often a simple explanation. Before calling the after-sales service, please refer to the fault table and attempt to correct the fault yourself.

Rectifying faults yourself

You can often easily rectify technical faults with the appliance yourself.

If a dish does not turn out exactly as you wanted, you can find useful cooking tips and instructions at the end of this instruction manual. → "Tested for you in our cooking studio" on page 23

Fault	Possible cause	Notes/remedy
Appliance does not start.	The circuit breaker is faulty.	Check the circuit breaker in the fuse box.
	Power failure	Check whether the kitchen light or other kitchen appliances are working.
	The child-proof lock is activated.	Check whether the function selector is in the childproof lock position.
Oven/hob does not heat up.	Dust on the contacts.	Turn the switch to the right and left a couple of times.
	The child-proof lock is activated.	Check whether the function selector is in the childproof lock position.

Warning – Risk of injury!

Incorrect repairs are dangerous. Do not attempt to repair the appliance yourself. Repairs must only be carried out by one of our trained after-sales engineers. If the appliance is defective, call the after-sales service.

Warning – Risk of electric shock!

Incorrect repairs are dangerous. Repairs may only be carried out and damaged power cables replaced by one of our trained after-sales technicians. If the appliance is defective, unplug the appliance from the mains or switch off the circuit breaker in the fuse box. Contact the after-sales service.

Replacing the bulb in the top of the cooking compartment

If the cooking compartment light bulb fails, it must be replaced. Heat-resistant, 25 watt, 230 V halogen bulbs are available from the after-sales service or specialist retailers.

When handling the halogen bulb, use a dry cloth. This will increase the service life of the bulb. Only use these bulbs.

Warning – Risk of electric shock!

When replacing the cooking compartment bulb, the bulb socket contacts are live. Before replacing the bulb, unplug the appliance from the mains or switch off the circuit breaker in the fuse box.

Warning – Risk of burns!

The appliance becomes very hot. Never touch the interior surfaces of the cooking compartment or the heating elements. Always allow the appliance to cool down. Keep children at a safe distance.

1. Place a tea towel in the cold cooking compartment to prevent damage.
2. Turn the glass cover anti-clockwise to remove it (figure 1).
3. Pull out the bulb – do not turn it (figure 2). Insert the new bulb, making sure that the pins are in the correct position. Push the bulb in firmly.

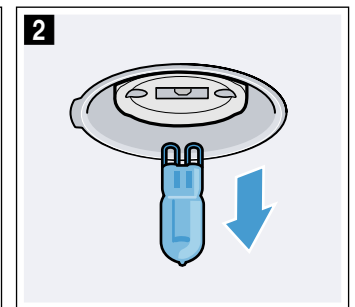
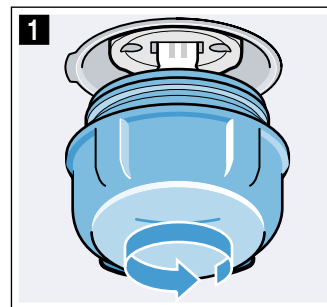

4. Screw the glass cover back on. Depending on the appliance model, the glass cover may have a sealing ring. If the glass cover has a sealing ring, put it back in place before screwing the cover back on.
5. Remove the tea towel and switch on the circuit breaker.

Customer service

Our after-sales service is there for you if your appliance needs to be repaired. We will always find an appropriate solution, also in order to avoid after-sales personnel having to make unnecessary visits.

E number and FD number

When calling us, please give the product number (E no.) and the production number (FD no.) so that we can provide you with the correct advice. The rating plate containing these numbers is found on the side of the oven door. To save time, you can make a note of the number of your appliance and the telephone number of the after-sales service in the space below, should it be required.

E no.		FD no.	
After-sales service 			

Please note that there will be a fee for a visit by a service technician in the event of a malfunction, even during the warranty period.

Please find the contact data of all countries in the enclosed customer service list.

To book an engineer visit and product advice

GB 0344 892 8979
Calls charged at local or mobile rate.

IE 01450 2655
0.03 € per minute at peak. Off peak 0.0088 € per minute.

Rely on the professionalism of the manufacturer. You can therefore be sure that the repair is carried out by trained service technicians who carry original spare parts for your appliances.

Tested for you in our cooking studio

Here, you can find a selection of dishes and the ideal settings for them. We will show you which type of heating and temperature are best suited to your dish. You will get information on suitable cooking accessories and the height at which they should be placed in the oven. You will also get tips about cookware and preparation methods.

Note: A lot of steam can build up in the cooking compartment when cooking food. Your appliance is very energy-efficient and radiates very little heat to its surroundings during operation. Due to the significant differences in temperature between the appliance interior and the external parts of the appliance, condensation may build up on the door, the control panel or the front panels of adjacent kitchen cabinets. This is a normal physical phenomenon. Condensation can be reduced by preheating the oven or opening the door carefully.

General information

Recommended setting values

The table lists the optimal heating function for various types of food. The temperature and cooking time depend on the amount of food and the recipe. For this reason, the table specifies setting ranges. Try using the lower value to start with. A lower temperature will result in more even browning. You can increase the temperature next time if necessary.

Note: Cooking times cannot be reduced by using higher temperatures. The food would only be cooked on the outside, but would not be fully cooked in the middle.

The setting values apply to food placed in the cooking compartment while the cooking compartment is still cold. This will save energy. If you preheat the oven, you can reduce the indicated baking times by several minutes.

Preheating is necessary for selected types of food – this is indicated in the table. Do not place your food and accessory into the cooking compartment until it has finished preheating.

If you wish to follow one of your own recipes, you should use the settings listed in the table for similar food as reference. Additional information can be found in the baking tips listed after the settings tables.

Remove any accessories that are not being used from the cooking compartment. This will allow you to achieve optimal cooking results while saving energy.

Gentle top/bottom type of heating

Gentle top/bottom heating is an intelligent type of heating that allows you to gently cook meat, fish and baked items that do not need to rise. The appliance optimally controls the supply of energy to the cooking compartment. The food is cooked in phases using residual heat. This means that it remains more succulent and browns less. Depending on the method of preparation and the type of food, it is possible to save energy. If you open the appliance door before the food has finished cooking or if you preheat the appliance, you are not able to achieve this result.

Only use genuine accessories for your appliance. These have been tailored to the cooking compartment and the types of heating of your appliance. Remove any accessories that are not being used from the cooking compartment.

Place the food into the empty cooking compartment before the oven has heated up. Select a temperature of between 120 °C and 250 °C. Always keep the appliance door closed when cooking. Only cook on one level.

The top/bottom heating gentle is used to measure both the energy consumption in air recirculation mode and the energy efficiency class.

Baking on one level

When baking on one level, use the following shelf positions:

- Position 2 – tall baked items and tins/dishes on the wire rack
- Position 3 – shallow baked items and baking trays

Accessories

Only use original accessories supplied with your appliance. These have been tailored to the cooking compartment and the operating modes of your appliance.

Ensure that you always use suitable accessories and that they are placed in the oven the right way around.
→ "Accessories" on page 12

Cakes in tins

Dish	Accessories/cookware	Shelf position	Heating function	Temperature in °C	Cooking time in min
Sponge cake, simple	Vienna ring tin/loaf tin	2		160-180	50-60
Sponge cake, delicate	Vienna ring tin/loaf tin	2		150-170	60-80
Sponge flan base	Flan tin	3		160-180	30-40
Fruit tart or cheesecake with shortcrust pastry base	26 cm springform cake tin	2		160-180	70-90
Tart	Tart dish or tin	1		200-240	25-50
Scones	28 cm springform cake tin	2		160-180	25-35
Bundt cake	Bundt cake tin	2		150-170	60-80
3-egg fatless sponge cake	26 cm springform cake tin	2		160-180	30-40
6-egg fatless sponge cake	28 cm springform cake tin	2		160-180	35-45

Greaseproof paper

Only use greaseproof paper that is suitable for the selected temperature. Always cut greaseproof paper to size.

Cakes and pastries

Your appliance offers you a range of heating types for the preparation of cakes and small baked items. You can find the ideal settings for many dishes in the settings tables.

Also refer to the notes in the section on allowing dough to rise.

Baking tins

For optimal cooking results, we recommend using dark-coloured metal baking tins.

Tinplate baking tins, ceramic dishes and glass dishes extend baking time and mean that the baked item will not brown evenly.

If you are using silicone moulds, follow the manufacturer's instructions and recipes. Silicone moulds are often smaller than normal baking tins. Quantity and recipe specifications may vary.

Frozen products

Do not use frozen products that are heavily frosted. Remove any ice on the food.

Some frozen products may be unevenly pre-baked. Uneven browning may remain even after baking.

Bread and rolls









Caution!

Never pour water into the hot cooking compartment or place cookware containing water onto the bottom of the cooking compartment. The change in temperature can cause damage to the enamel.

Some food turns out better if it is baked in several stages. These dishes are indicated in the table.





The setting values for bread dough apply to both dough placed on a baking tray and dough placed in a loaf tin.

Cakes on trays





Dish	Accessories/cookware	Shelf position	Heating function	Temperature in °C	Cooking time in min
Sponge cake with topping	Universal pan	3		160-180	20-45
Shortcrust tart with dry topping	Universal pan	2		170-190	25-35
Shortcrust tart with moist topping	Universal pan	2		160-180	60-90
Yeast cake with dry topping	Universal pan	3		170-180	25-35
Yeast cake with moist topping	Universal pan	3		160-180	30-50
Plaited loaf, savarin	Universal pan	2		160-170	35-40
Swiss roll	Universal pan	2		170-190*	15-20
Strudel, sweet	Universal pan	2		190-210	55-65
Strudel, frozen	Universal pan	3		200-220	35-40

* Preheat for 10 minutes

Small baked items









Dish	Accessories/cookware	Shelf position	Heating function	Temperature in °C	Cooking time in min
Muffins	Muffin tray	2		170-190	20-40
Small baked items	Universal pan	3		160-180	25-35
Puff pastry	Universal pan	3		200-220	20-30
Choux pastry	Universal pan	3		190-210	35-50

Biscuits

Dish	Accessories/cookware	Shelf position	Heating function	Temperature in °C	Cooking time in min
Viennese whirls	Universal pan	3		140-150*	30-40
Biscuits	Universal pan	3		140-160	20-30
Meringue	Universal pan	3		80-100	100-150
Macaroons	Universal pan	2		100-120	30-40

* Preheat

Bread and rolls

Dish	Accessories/cookware	Shelf position	Heating function	Step	Temperature in °C	Cooking time in min
Bread, 750 g (in a loaf tin or free-form)	Universal pan or loaf tin	2		-	180-200	50-60
Bread, 1000 g (in a loaf tin or free-form)	Universal pan or loaf tin	2		-	200-220	35-50
Bread, 1500 g (in a loaf tin or free-form)	Universal pan or loaf tin	2		-	180-200	60-70
Flatbread	Universal pan	2		-	240-250	25-30
Bread rolls, sweet, fresh	Universal pan	3		-	170-180*	20-30
Bread rolls, fresh	Universal pan	3		-	200-220	20-30
Toast with topping, 4 slices	Wire rack	3		-	200-220	15-20
Toast with topping, 12 slices	Wire rack	3		-	220-240	15-25

* Preheat

Pizza, quiche and savoury cakes

Dish	Accessories/cookware	Shelf position	Heating function	Temperature in °C	Cooking time in min
Pizza, fresh	Universal pan	2		190-210	20-30
Pizza, fresh, thin-crust	Universal pan	2		250-270*	15-25
Pizza, chilled	Universal pan	3		190-210*	10-15
Pizza, frozen, thin-crust, x 1	Wire rack	2		190-210	15-25
Pizza, frozen, deep-pan, x 1	Wire rack	2		200-210	20-30
Mini pizzas	Universal pan	3		190-210	10-20
Savoury cakes in a tin	28 cm springform cake tin	3		170-190	50-60
Quiche	Tart dish or tin	1		210-230	40-50
Tart	Ovenproof dish	2		180-200	55-65
Empanadas	Universal pan	2		180-200	40-50
Börek	Universal pan	2		190-210	40-50

* Preheat

Baking tips



You want to find out whether the cake is completely cooked in the middle.	Push a cocktail stick into the highest point on the cake. If the cocktail stick comes out clean with no cake mixture on it, the cake is ready.
The cake collapses.	Next time use less liquid. Alternatively, set the temperature 10 °C lower and extend the baking time. Use the ingredients and preparation instructions given in the recipe.
The cake has risen in the middle but is lower around the edges.	Only grease the base of the springform cake tin. After baking, loosen the cake carefully with a knife.
The fruit juice overflows.	Next time, use the universal pan.
Small baked items stick to one another when they are baked.	Leave a gap of approx. 2 cm between each baked item. This allows enough space for the baked items to expand well and brown on all sides.
The cake is too dry.	Set the temperature 10 °C higher and shorten the baking time.
The cake is too light in colour.	If the shelf position and the accessory are correct, then you should increase the temperature if necessary or extend the baking time.
The cake is too light on top and too dark underneath.	Bake the cake one level higher in the oven next time.
The cake is too dark on top and too light underneath.	Bake the cake one level lower in the oven next time. Select a lower temperature and extend the baking time.
The back of a cake baked in a tin or loaf tin is too dark.	Place the baking tray in the middle of the accessory, not directly against the back panel of the oven.
The cake is very dark.	Next time, select a lower temperature and extend the baking time if necessary.
The cake is unevenly browned.	Select a slightly lower temperature. Excess greaseproof paper can affect the air circulation. Always cut greaseproof paper to size. Ensure that the baking tin is not standing directly in front of the openings in the cooking compartment back panel. Small baked items should be of roughly equal size and thickness.
The cake looks good but is not cooked properly in the middle.	Select a lower temperature and extend the baking time. Add less liquid if necessary. For cakes with a moist topping, bake the base first. Sprinkle it with almonds or breadcrumbs and then place the topping on top.
The cake will not come out of the tin when turned upside down.	Allow the cake to cool down for 5 to 10 minutes after baking. If it still sticks, carefully loosen the cake around the edges using a knife. Turn the cake tin upside down again and cover it with a cold, wet cloth. Next time, grease the tin and sprinkle with breadcrumbs.

Bakes and gratins

Your appliance offers a range of heating functions for cooking bakes. The settings tables list the optimal settings for a wide range of dishes.

How well cooked a bake is will depend on the size of the cookware and the shelf position of the bake.

Use wide, shallow cookware for bakes and gratins. Food takes longer to cook in deep, narrow cookware and it browns more on top.

Dish	Accessories/cookware	Shelf position	Heating function	Temperature in °C	Cooking time in min
Bake, savoury, cooked ingredients	Ovenproof dish	2		200-220	30-60
Bake, sweet	Ovenproof dish	2		180-200	50-60
Potato gratin, raw ingredients, 4 cm deep	Ovenproof dish	2		160-180	60-80

Poultry, meat and fish

Your appliance offers you a range of heating types for preparing poultry, meat and fish. You can find the ideal settings for certain dishes in the settings tables.

Roasting on the wire rack

Roasting on the wire rack works particularly well for large poultry or for multiple pieces at the same time.

Place the food to be grilled directly onto the wire rack. If you are grilling a single piece, place it in the centre of the wire rack for best results.

The universal pan should also be inserted at position 1. This will catch the meat juices that drip down and keeps the cooking compartment clean.

Add up to ½ litre of water to the universal pan, depending on the size and type of joint. This will catch the liquid that drips down. You can make a sauce from these juices. This will also result in less smoke being produced and keep the cooking compartment clean.

Roasting in cookware

Warning – Risk of injury caused by shattering glass!

Place hot glass cookware on a dry mat after cooking. If the surface is damp or cold, the glass may crack.

Warning – Risk of scalding!

Very hot steam may escape when opening the lid after cooking. Lift the lid at the rear, so that the hot steam can escape away from you.

Only use cookware which is suitable for use in an oven. Glass cookware is best. Check whether the cookware fits in the cooking compartment.

Shiny roasting dishes made from stainless steel or aluminium reflect heat like a mirror and are therefore not particularly suitable. The poultry, meat and fish cooks slower and does not brown so well. Use a higher temperature and/or a longer cooking time.

Observe the manufacturer's instructions for your roasting cookware.

Uncovered cookware

To cook poultry, meat and fish, it is best to use a deep

Always use the shelf positions indicated.

You can cook food on one level in baking tins/dishes or in the universal pan.

- Baking tins/dishes on the wire rack: Position 2
- Universal pan, position 3

You can cut energy use by cooking different items at the same time. Position baking tins/dishes next to one another in the cooking compartment.

roasting tin. Place the tin onto the wire rack. If you do not have any suitable cookware, use the universal pan.

Covered cookware

When cooking with covered cookware, the cooking compartment remains considerably cleaner. Ensure that the lid fits well and closes properly. Place the cookware onto the wire rack.

Poultry, meat and fish can also become crispy in a covered roasting dish. Simply use a roasting dish with a glass lid and set a higher temperature.

Grilling

Keep the appliance door closed when using the grill. Never grill with the appliance door open.

Place the food to be grilled on the wire rack. In addition, slide the universal pan in at least one shelf position lower, with the slanted edge facing the appliance door. Any dripping fat will be caught.

When grilling, try wherever possible to use pieces of food which are of a similar thickness and weight. This will allow them to brown evenly and remain succulent and juicy. Place the food to be grilled directly onto the wire rack.

Use tongs to turn the pieces of food you are grilling. If you pierce the meat with a fork, the juices will run out and it will become dry.

Do not add salt to the meat until it has been grilled. Salt draws water from the meat.

Notes

- The grill element switches itself on and off repeatedly; this is normal. The grill setting determines how frequently this occurs.
- Smoke may be produced when grilling.
- When you are using the grill, do not insert the baking tray or universal pan into the cooking compartment any higher than shelf position 3. The high temperatures at the top of the cooking compartment can warp accessories, which may damage the cooking compartment when removed.

Meat thermometer

Depending on your appliance's features, you may have a meat thermometer. You can cook accurately using a meat thermometer. Read important notes on using the meat thermometer in the corresponding chapter. There, you can find notes on inserting the meat thermometer, the possible heating types and additional information.

Recommended setting values

The setting values are based on the assumption that unstuffed, chilled, ready-to-roast poultry, meat or fish is placed into a cold cooking compartment.

In the table, you can find specifications for poultry, meat and fish with default values for the weight. If you wish to prepare heavier poultry, meat or fish, always use the lower temperature. If roasting several joints, use the weight of the heaviest piece as a basis for determining the cooking time. The individual pieces should be approximately equal in size.

The larger the poultry, meat or fish is, the lower the cooking temperature and the longer the cooking time.

Turn the poultry, meat and fish after approx. 1/2 to 2/3 of the indicated time.

Poultry

When cooking duck or goose, pierce the skin on the underside of the wings. This allows the fat to run out.

If using duck breast, score the skin. Do not turn duck breasts.

Add some liquid to the poultry in the dish. Cover the base of the ovenware with approx. 1-2 cm of liquid.

When you turn poultry, ensure that the breast side or the skin side is underneath at first.

Poultry will turn out particularly crispy and brown if you baste it towards the end of the roasting time with butter, salted water or orange juice.

Meat

Baste lean meat with fat as required or cover it with strips of bacon.

Poultry

Dish	Accessories/cookware	Shelf position	Heating function	Temperature in °C	Cooking time in min
Chicken, 1.3 kg	Wire rack	2		200-220	60-80
Small chicken portions, 250 g each	Wire rack	3		210-230	40-50
Chicken, goujons, nuggets, frozen	Universal pan	3		190-210	20-30
Duck, 2 kg	Wire rack	2		200-220	100-120
Duck breast, medium, 300 g each	Wire rack	3		210-230	35-40
				3	3-5
Goose, 3 kg	Wire rack	2		200-220	120-140
Goose legs, 350 g each	Wire rack	3		230-250	40-50
Small turkey, 2.5 kg	Wire rack	2		210-230	80-100

When roasting, add a little liquid if the meat is lean. A covering of approx. 1/2 cm depth should be applied to the base of any glass cookware.

Score the rind crosswise. If you turn the joint when cooking, ensure that the rind is underneath at first.

When the joint is ready, turn off the oven and allow it to rest for another 10 minutes in the cooking compartment. This allows the meat juices to be better distributed. Wrap the joint in aluminium foil if necessary. The recommended resting time is not included in the cooking time indicated.

It is more convenient to roast and braise meat in cookware. You can take the joint out of the cooking compartment more easily in the cookware, and prepare the sauce in the cookware itself.

The quantity of liquid is dependent on the type of meat, the cookware material and also on whether or not a lid is used. If preparing meat in an enamelled or dark metal roasting dish, it will need a little more liquid than if cooked in glass cookware.

The steam evaporates in the cookware when roasting. Carefully pour in more liquid if required.

The distance between the meat and the lid should be at least 3 cm. The meat may rise.



If necessary, braise the meat first by searing it. Add water, wine, vinegar or a similar liquid to the braising liquid. A covering approx. 1-2 cm deep should be applied to the base of the cookware.

Fish















Fish cooked whole does not have to be turned. Place the whole fish into the cooking compartment in swimming position with the dorsal fin facing upwards. Placing half a potato or a small oven-proof container in the stomach cavity of the fish will provide stability.

You can tell when the fish is cooked because the dorsal fin can be removed easily.

When stewing, add two to three tablespoons of liquid and a little lemon juice or vinegar into the cookware.

Dish	Accessories/cookware	Shelf position	Heating function	Temperature in °C	Cooking time in min
Turkey breast, boned, 1 kg	Cookware, covered	2		240-260	80-90
Turkey thigh, bone in, 1 kg	Wire rack	2		190-210	100-120





Meat

Dish	Accessories/cookware	Shelf position	Heating function	Step	Temperature in °C	Cooking time in min
Joint of pork without rind, e.g. neck, 1.5 kg	Cookware, uncovered	2		-	210-230	140-160
Joint of pork with rind, e.g. shoulder, 2 kg	Cookware, uncovered	2		-	210-230	170-190
Pork tenderloin steak, 1.5 kg	Cookware, uncovered	2		-	190-210	130-140
Pork steaks, 2 cm thick	Wire rack	4		-	3	20-25**
Fillet of beef, medium, 1 kg	Cookware, uncovered	3		-	210-220	45-55
Pot-roasted beef, 1.5 kg	Cookware, uncovered	2		-	210-220	90-100
Sirloin, medium, 1.5 kg	Cookware, uncovered	2		-	210-220	60-70
Burger, 3-4 cm thick	Wire rack	4		-	3	25-30**
Joint of veal, 1.5 kg	Cookware, uncovered	2		-	180-200	120-140
Knuckle of veal, 1.5 kg	Cookware, uncovered	2		-	210-230	130-150
Leg of lamb, boned, medium, 1.5 kg	Cookware, uncovered	2		-	200-210	70-80*
Saddle of lamb on the bone, medium, 1.5 kg	Wire rack	2		-	190-200	60-70*/**
Grilling sausages	Wire rack	3		-	3	20-25**
Meat loaf, 1 kg	Cookware, uncovered	2		-	190-200	70-80

* Do not turn

** Slide the universal pan in at shelf position 1

Fish

Fish	Weight	Accessories and cookware	Position	Heating function	Temperature in °C, grill setting	Cooking time in minutes
Fish, whole	Approx. 300 g each	Wire rack	2		2	20-25
	1.0 kg	Wire rack	2		200-220	55-65
	1.5 kg	Wire rack	2		190-210	50-60
Fish steaks, 3 cm thick		Wire rack	3		2	20-25
Fish fillet		Covered	2		210-230	20-30



Tips on roasting and braising

The cooking compartment becomes very dirty.	Prepare your food in an enclosed roasting dish with higher temperature or use the grill tray. You will achieve the best roasting results if you use the grill tray. The grill tray can be bought later as a special accessory.
The roast is too dark and the crackling is burned in places, and/or the roast is too dry.	Check the shelf position and temperature. Select a lower temperature the next time and reduce the roasting time if necessary.
The crackling is too thin.	Increase the temperature or switch on the grill briefly at the end of the roasting time.
The roast looks good but the juices are burnt.	Next time, use a smaller roasting dish and add more liquid if necessary.
The roast looks good but the juices are too clear and watery.	Next time, use a larger roasting dish and add less liquid if necessary.
The meat gets burned during braising.	The roasting dish and lid must fit together well and close properly. Reduce the temperature and add more liquid when braising if necessary.

Vegetables and side dishes

Adhere to the specifications in the table.

Here, you can find information for preparing grilled vegetables, potatoes and frozen potato products.

Dish	Accessories/cookware	Shelf position	Heating function	Temperature in °C	Cooking time in min
Grilled vegetables	Universal pan	5		3	10-20
Baked potatoes, halved	Universal pan	3		170-190	55-65
Potato products, frozen, e.g. chips, croquettes, potato pockets, rösti	Universal pan	3		200-220	25-35

Yoghurt

You can use your appliance to make your own yoghurt.

Remove accessories and shelf supports from the cooking compartment. The cooking compartment must be empty.

1. Heat 1 litre of milk (3.5% fat) to 90 °C on the hob and then leave it to cool down to 40 °C.

- It is sufficient to heat UHT milk to 40 °C.
2. Stir in 30 g (approx. 1 tbsp) (chilled) yoghurt.
 3. Pour into cups or small jars with lids and cover.
 4. Place the cups or jars onto the cooking compartment floor and use the settings indicated in the table.
 5. After making the yoghurt, leave it to cool in the refrigerator.

Dish	Accessories/cookware	Shelf position	Heating function	Temperature in °C	Cooking time
Yoghurt	Cup/jar	Cooking compartment floor		-	4-5h

Acrylamide in foodstuffs

Acrylamide is mainly produced in grain and potato products prepared at high temperatures, such as potato

crisps, chips, sliced bread, bread rolls, bread or fine baked goods (biscuits, gingerbread, spiced biscuit).

Tips for keeping acrylamide to a minimum	
General	<ul style="list-style-type: none"> ■ Keep cooking times as short as possible. ■ Cook food until it is golden brown, but not too dark. ■ Large, thick pieces of food contain less acrylamide.
Baking	With top/bottom heating at max. 200 °C. With hot air at max. 180 °C.
Biscuits	With top/bottom heating at max. 190 °C. With hot air at max. 170 °C. Egg or egg yolk reduces the production of acrylamide.
Oven chips	Spread out a single layer evenly on the baking tray. Cook approx. 400-600 g at once on a baking tray so that the chips do not dry out and become crunchy.

Preserving

For preserving, the jars and rubber seals must be clean and intact. If possible, use jars of the same size. The information in the table is for round, one-litre jars.

Caution!

Do not use jars that are larger or taller than this. The lids could crack.

Only use fruit and vegetables in good condition. Wash them thoroughly.

The times given in the tables are a guide only. The time will depend on the room temperature, number of jars, and the quantity and temperature of the contents. Before you switch off the appliance or change the cooking mode, check whether the contents of the jars are bubbling as they should.

Preparation

1. Fill the jars, but not to the top.
2. Wipe the rims of the jars, as they must be clean.
3. Place a damp rubber seal and a lid on each jar.

Fruit in one-litre jars	When it starts to bubble	Residual heat
Apples, redcurrants, strawberries	Switch off	approx. 25 minutes
Cherries, apricots, peaches, gooseberries	Switch off	approx. 30 minutes
Apple purée, pears, plums	Switch off	approx. 35 minutes

Vegetables

As soon as bubbles begin to form in the jars, set the temperature back to between 120 and 140 °C.

4. Seal the jars with the clips. Place no more than six jars in the cooking compartment.

Settings

1. Insert the universal pan at level 2. Arrange the preserving jars so that they do not touch each other.
2. Pour ½ litre of water (approx. 80 °C) into the universal pan.
3. Close the oven door.
4. Set Bottom heat .
5. Set the temperature to 170 - 180 °C.

Preserving

Fruit

After approx. 40 to 50 minutes, small bubbles begin to form at short intervals. Switch off the oven.

After 25 to 35 minutes of residual heat, remove the preserving jars from the cooking compartment. If they are allowed to cool for longer in the cooking compartment, germs could multiply, promoting acidification of the preserved fruit.

Depending on the type of vegetable, heat for approx. 35 to 70 minutes. Switch off the oven after this time and use the residual heat.

Vegetables with cold cooking water in one-litre jars	When it starts to bubble	Residual heat
Gherkins	-	approx. 35 minutes
Beetroot	approx. 35 minutes	approx. 30 minutes
Brussels sprouts	approx. 45 minutes	approx. 30 minutes
Beans, kohlrabi, red cabbage	approx. 60 minutes	approx. 30 minutes
Peas	approx. 70 minutes	approx. 30 minutes

Taking out the jars

After preserving, remove the jars from the cooking compartment.

Caution!

Do not place the hot jars on a cold or wet surface. They could suddenly burst.

Prove dough

Your yeast dough will prove considerably more quickly using this heating function than at room temperature and will not dry out. Do not start the appliance if the cooking compartment is not completely cool.

Always allow yeast dough to prove twice. Use the settings indicated in the settings tables for the first and second proving stages (dough fermentation stage and final fermentation stage).

Dough fermentation

Place the dough into a heat-resistant bowl and place this onto the wire rack. Use the settings indicated in the table.

Do not open the appliance door while the dough is proving, otherwise moisture will escape. Do not cover the dough.

Condensation builds up during the proving process, which steams up the door panel. Wipe out the cooking compartment after dough proving. Remove any limescale with a little vinegar and wipe with clean water.

Final fermentation

Place your dough into the oven at the shelf position indicated in the table.

If you want to preheat the oven, the final fermentation stage takes place outside the appliance in a warm place.

The temperature and proving time are dependent on the type and quantity of the ingredients. For this reason, the values indicated in the settings table are intended as a guide only.

Dish	Accessories/cookware	Shelf position	Heating function	Step	Temperature in °C	Cooking time in mins
Yeast dough, light	Bowl	2		1.	-*	25-30
	Universal pan or loaf tin	2		2.	-*	10-20
Yeast dough, heavy and rich	Bowl	2		1.	-*	60-75
	Universal pan or loaf tin	2		2.	-*	45-60

* Heat up up to 50 °C with

Test dishes

These tables have been produced for test institutes to facilitate appliance testing.

As per EN 60350-1.

Baking

Baked items or cakes that are placed in the oven on baking trays or in baking tins/dishes at the same time will not necessarily be ready at the same time.

Shelf positions for baking on one level:

- Universal pan/baking tray: Position 3
- Baking tins/dishes on the wire rack
Wire rack: Position 2

Baking with two springform cake tins:

- On one level (figure 1)

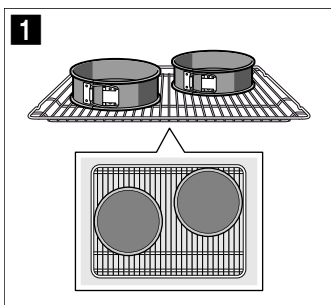

Notes





- The setting values apply to dishes placed into a cold cooking compartment.
- Please note the information in the tables about preheating. The setting values are valid without rapid heating-up.

- For baking, use the lower of the indicated temperatures first.

Grilling



Also slide in the universal pan. The liquid will be caught and the cooking compartment stays cleaner.

Baking

Dish	Accessories/cookware	Shelf position	Heating function	Temperature in °C	Cooking time in min
Viennese whirls	Universal pan	3		140-150*	25-35
Small cakes	Universal pan	3		160-170*	20-35
Hot water sponge cake	26 cm springform cake tin	2		160-170*	30-40
Double-crust ed apple pie	2 x 20 cm black cake tins	2		170-190	80-100

* Preheat; do not use rapid heat-up function

Grilling

Dish	Accessories	Shelf position	Heating function	Temperature in °C	Cooking time in mins
Toasting bread Preheat for 10 min	Wire rack	5		3	0,2-1,5
Beefburgers, x 12 * Do not preheat	Wire rack	4		3	25-30*

* Turn after 2/3 of the total time



Thank you for buying a Bosch Home Appliance!

Register your new device on MyBosch now and profit directly from:

- **Expert tips & tricks for your appliance**
- **Warranty extension options**
- **Discounts for accessories & spare-parts**
- **Digital manual and all appliance data at hand**
- **Easy access to Bosch Home Appliances Service**

Free and easy registration – also on mobile phones:

www.bosch-home.com/welcome



Looking for help? You 'll find it here.

Expert advice for your Bosch home appliances, need help with problems or a repair from Bosch experts.

Find out everything about the many ways Bosch can support you:

www.bosch-home.com/service

Contact data of all countries are listed in the attached service directory.

Robert Bosch Hausgeräte GmbH

Carl-Wery-Straße 34

81739 München

Germany

www.bosch-home.com



9001433269

010125(C)