

ELVITA



**User manual**  
Induction cooker  
CIS56231V

---

## Thank you

for your trust and the purchase of our product. This user manual is supplied to help you use this product. The instructions should allow you to learn about your new product as quickly as possible.

Make sure you have received an undamaged product. If you do find transport damage, please contact the seller from which you purchased the product, or the regional warehouse from which it was supplied.

ELVITA

Language: en-GB, Publication date: 2021-06-17

This document and its content, including written material and images, are the property of Elon Group AB. You may not copy, reproduce, modify, republish or distribute this document or any of its content without express written permission from Elon Group AB. © 2020, Elon Group AB. All rights reserved.

---



## **Warranty**

Consumer warranty regarding quality of product applies.

**ELVITA**

# Contents

<b>SAFETY</b>	<b>7</b>
Admonitions .....	7
Intended use .....	7
Safety for children and people with disabilities.....	7
General safety.....	8
Safety during installation .....	8
Safety during operation .....	9
Safety during maintenance .....	10
Safety labels.....	11
Disposal.....	11
<b>QUICK START</b>	<b>12</b>
Quick start oven .....	12
Quick start hob .....	13
<b>GETTING STARTED</b>	<b>14</b>
Installation.....	14
Before you use the cooker .....	14
Hob overview .....	14
Hob control panel .....	14
Oven controls .....	15
Open the child lock .....	15
Accessories.....	15
<b>COOKING WITH THE HOB</b>	<b>17</b>
<b>Hob overview</b> .....	<b>17</b>
Hob surface .....	17
Hob operating principle .....	17
Suitable cookware.....	17
<b>Basic hob operation</b> .....	<b>18</b>
Turn on the hob .....	18
Turn on a cooking zone.....	18
Turn off a cooking zone.....	18
Hob power levels.....	18
Turn off the hob.....	19
Use power boost.....	19
Save energy .....	19
<b>Additional hob features</b> .....	<b>20</b>
Use the bridged cooking zone .....	20
Automatic hob power-off.....	20
Automatic cooking zone power-off .....	20
Residual heat indicator .....	20
Use the child lock .....	20
Use the timer .....	20

<b>COOKING WITH THE OVEN</b>	<b>22</b>
<b>Cooking modes</b> .....	<b>22</b>
FastPreheat .....	22
Top and bottom heater .....	22
Bottom heater and fan .....	22
Grill .....	22
Large grill .....	22
Grill with fan .....	23
Hot air .....	23
Hot air and bottom heater .....	23
GentleBake .....	23
Defrost .....	23
WaterClean .....	24
<b>Turn on and off the oven</b> .....	<b>24</b>
<b>Change oven temperature</b> .....	<b>24</b>
<b>Change oven cooking mode</b> .....	<b>24</b>
<b>Oven cooking mode guide</b> .....	<b>24</b>
<b>Wire guides</b> .....	<b>25</b>
<b>Pre-heat the oven</b> .....	<b>25</b>
<b>Grilling recommendations</b> .....	<b>26</b>
<b>Roasting recommendations</b> .....	<b>26</b>
<b>Baking recommendations</b> .....	<b>26</b>
<b>Preserve food</b> .....	<b>26</b>
<b>CLEANING</b>	<b>28</b>
<b>Clean the hob surface</b> .....	<b>28</b>
<b>Clean glass surfaces</b> .....	<b>28</b>
<b>Clean stainless steel surfaces</b> .....	<b>29</b>
<b>Clean enamel surfaces</b> .....	<b>29</b>
<b>Clean plastic parts and lacquer-coated surfaces</b> .....	<b>29</b>
<b>Clean the oven</b> .....	<b>29</b>
<b>Use the WaterClean programme</b> .....	<b>29</b>
<b>TROUBLESHOOTING</b>	<b>30</b>
<b>General troubleshooting</b> .....	<b>30</b>
<b>Hob troubleshooting</b> .....	<b>30</b>
<b>Normal noise during cooking with the hob</b> .....	<b>31</b>
<b>Oven troubleshooting</b> .....	<b>31</b>
<b>Replacing parts</b> .....	<b>32</b>
Replace the oven light bulb .....	32
Replace the oven door .....	32
Remove and install the oven door glass panes .....	33
Remove and install the wire guides .....	33
<b>INSTALLATION</b>	<b>35</b>
<b>Cooker placement</b> .....	<b>35</b>

---

<b>Secure the cooker to a wall .....</b>	<b>35</b>
<b>Adjust the height of the cooker.....</b>	<b>36</b>
<b>Level the cooker .....</b>	<b>36</b>
<b>Connect the mains power.....</b>	<b>37</b>
<b>Set maximum hob power .....</b>	<b>38</b>
<b>APPENDIX .....</b>	<b>39</b>
<b>Specifications .....</b>	<b>39</b>
<b>EU directives and standards.....</b>	<b>39</b>

## SAFETY

Carefully read the instructions before you install and use the product. Save the instructions and keep them near the product for future reference. All kinds of warranties shall be invalid if these instructions are not followed.

### Admonitions

**WARNING!**

Used when there is a risk for personal injury.

**CAUTION!**

Used when there is a risk for damage to the product.

**NOTE!**

General information that you should be aware of.



**Helpful tips that you may find useful.**

### Intended use

This product is intended

- to be used in a household setting.
- for heating and cooking various foodstuff.
- to be placed directly on the floor, without any supports or plinths.

This product is not intended

- for other purposes than cooking, for example room heating or similar purposes.
- to be installed as a built-in unit.
- for outdoor use.
- to be controlled by external timers or separate control systems.

### Safety for children and people with disabilities

**WARNING!**

- Keep children younger than 8 years old away from the product unless continuously supervised.
- Only let the following groups use the product if they are supervised or if instructions are provided to them about how to use the appliance in a safe way. They must understand the hazards involved.
  - Children. (Children younger than 8 years old must be continuously supervised.)
  - Persons with reduced physical, sensory or mental capabilities.
  - Persons with lack of experience and knowledge.

**WARNING!**

- Do not let children play with the product.
- Do not let children clean the product without supervision.

**WARNING!**

Only use hob guards designed or recommended by the manufacturer. The use of inappropriate hob guards may cause accidents.

## General safety

**WARNING!**

Risk of fire!

- Do not store items on the cooking surface.
- Do not store combustible, explosive, volatile or temperature-sensitive items (such as paper, dish cloths, plastic bags, cleaners or detergents and spray cans) in the oven's storage drawer, as they can ignite during over operation and cause a fire. Unattended cooking on a hob with fat or oil may result in a fire.
- Never try to put out a fire with water. Instead turn off the product and cover the flame with, for example, a lid or a fire proof blanket.

**WARNING!**

Risk of electric shock!

- If the cooking surface is cracked, turn off the product immediately and disconnect it from the mains. Do not use or touch the product.
- Keep power cords of other appliances at a safe distance so that they are not caught in the oven door, as the cords may become damaged and cause short-circuit.

## Safety during installation

**WARNING!**

Risk of fire!

- Make sure the floor and the adjacent walls are temperature resistant to at least 90°C.
- Do not install the product behind a decorative door, as it may become overheated.

**WARNING!**

Make sure all packaging remnants have been removed from the cooking compartment.

**WARNING!**

- The product is intended to be placed directly on the floor, without any support or plinths.
- If the supplied screws or anchors are not suitable for the wall, make sure you use ones that will ensure a secure installation on the wall.
- The cooker must be installed horizontally levelled.

**WARNING!**

Risk of electric shock! Do not connect the product to the mains yourself. The product may only be connected by an authorised technician.

**WARNING!**

- The electrical installation must follow local regulations.
- Make sure the protective earth wire is properly secured when connecting to the power supply.
- For single-phase power supply, use a 3×4.0 mm<sup>2</sup> cord marked H05VV-F 3G4 or better.
- For three-phase power supply, use a 5×1.5 mm<sup>2</sup> cord marked H05VV-F 5G1.5 or better.
- Do not use external timers or separate remote control systems to control the product.

**CAUTION!**

Do not install the product near powerful heat sources, such as solid fuel stoves, as the high temperature may damage the product.

**CAUTION!**

Carefully read the instructions for use before connecting the appliance to the power supply. Repair or any warranty claim resulting from incorrect connection or use of the product shall not be covered by the warranty.



## Safety during operation

**WARNING!**

Always supervise the cooking process continuously.

**WARNING!**

If the hob surface breaks, immediately disconnect the product from the mains. Do not use the product.

**WARNING!**

Risk of fire! Make sure the air vents are never covered or obstructed in any way.

**WARNING!**

Do not insert equipment between the cooking zone and the bottom of the cookware, for example equipment that makes it possible to use non-magnetic cookware. Use of such equipment may cause burns and damage on the cooker.

**WARNING!**

- After use, always turn off the cooking zone using the touch controls. If you remove the cookware, the cooking zone is turned off automatically, but do not rely on this.
- Do not leave the cooker unattended while using power boost. Power boost is extremely powerful.
- There is a risk of burns from residual heat. The cooking zone is indirectly heated by the heated cookware and stays hot for a while even after it is turned off.

**WARNING!**

Risk of burns!

- Cookware and accessible parts of the product may become very hot during use. Be careful not to touch hot parts.
- The oven door may become very hot during operation.
- Do not place metal objects like knives, forks, spoons, or lids on the cooking zones, as these objects can become very hot.

**WARNING!**

- Only use the grill with the oven door closed.
- Use oven mitts or meat tongs. The grill heater, grid, and other oven accessories get very hot during grilling.

**CAUTION!**

- The surface is very resistant to temperature changes but can be damaged by falling, heavy objects. The surface might break immediately or a while after being hit.
- Make sure the cooking zone and the bottom of the cookware are clean and dry to improve performance and prevent surface damage.
- If sugar, or food with high sugar content, is spilled over the surface when it is hot - immediately use a wipe or a scraper to remove the sugar from the hot surface. Otherwise the surface might become damaged.
- Never use detergents or other cleaners to clean a hot surface.
- Do not use the hob as a storage area as it may result in scratches or damages.
- Do not use aluminium or plastic cookware on hot cooking zones.
- Do not place any plastic objects or aluminium foil on the hob.

**CAUTION!**

- Do not turn the temperature selector below the zero position when changing the oven temperature. This can damage the thermostat.

**CAUTION!**

- Only use cookware with a flat bottom. Concave or convex bottoms, whether intended or not, may affect the heating process and damage the hob surface and the cookware.
- Do not line the oven walls with aluminium foil. Aluminium foil prevents air circulation in the oven, hinders the cooking process, and ruins the enamel coating.
- Do not place baking trays or other cookware on the bottom of the oven.
- Do not insert the deep baking tray into the first guide.

## Safety during maintenance

**WARNING!**

Risk of electric shock!

- Do not attempt to perform any repairs yourself. Tampering with the product and non-professional repair may cause injury or damage to the product. It also makes the warranty invalid. Instead, contact a service technician.
- Do not replace the power cord yourself. If the power cord is damaged, it must be replaced by the manufacturer or authorised technicians to avoid hazard.

**WARNING!**

Risk of electric shock! Before replacing the light bulb always disconnect the product from the mains.

**WARNING!**

Use protection when removing an old light bulb to avoid burning yourself.

**WARNING!**

Do not let children clean the product without supervision.

**WARNING!**

Risk of electric shock!

- Before cleaning, disconnect the product from the mains.
- Do not use steam cleaners or high pressure cleaners to clean the product, as this may result in electric shock.

**CAUTION!**

- Always wait for the product to cool down before cleaning.
- Make sure the oven has cooled down before you start the WaterClean programme.

**CAUTION!**

- Do not use steel wool, coarse cleaning sponges, or abrasive powder as they may scratch the surface. Aggressive spray cleaners, descaling agents, and other unsuitable liquid cleaners may also damage the surface.
- Do not use rough abrasive cleaners or sharp metal scrapers when cleaning glass surfaces, as they could crack the surface and cause the glass to break.
- Do not use abrasive cleaners or cleaners containing solvents when cleaning stainless steel surfaces, as they may damage the surface.
- Do not use abrasive cleaners or tools when cleaning enamel surfaces, as they may cause permanent damage.
- Do not use abrasive cleaners, abrasive tools, or alcohol-based cleaners when cleaning plastic parts and lacquer-coated surfaces.
- After cleaning, make sure to thoroughly remove any cleaner residue from the surface, since it may damage the surface when you heat up the cooking zones next time.

**CAUTION!**

- If sugar, or food with high sugar content, is spilled over the surface when it is hot - immediately use a wipe or a scraper to remove the sugar from the hot surface. Otherwise the surface might become damaged.
- Never use detergents or other cleaners to clean a hot surface.

**CAUTION!**

Do not lean against the open door when cleaning the oven cavity. Never stand on the open oven door and do not let children sit on it. The oven door hinges may be damaged under excessive load.

**CAUTION!**

Make sure the hinges are correctly positioned in their hooks when replacing the oven door. Otherwise the door may not open and close properly.

**CAUTION!**

Do not clean the telescopic guides in a dishwasher.

**CAUTION!**

Do not damage the enamel surface when replacing the light bulb.

## Safety labels

These safety labels can be found on the product.



Caution! Risk of tilting.



Warning! Stabilising means must be installed to prevent tipping.

## Disposal



Dispose of packaging in an environmentally-friendly manner. Recycling packaging, while observing national and local regulations, can reduce the consumption of raw materials and the amount of waste in landfill sites.

This product is marked in compliance with European Directive 2012/19/EU, Waste Electrical and Electronic Equipment (WEEE). The symbol on the product or on its packaging indicates that this product should not be treated as household waste. Instead it shall be handed over to the applicable collection point for the recycling of electrical and electronic equipment.

By ensuring this product is disposed of correctly, you will help prevent potential negative consequences for the environment and human health, which could otherwise be caused by inappropriate waste handling of this product. For more detailed information about recycling of this product, please contact the relevant municipal body in charge of waste management, your household waste disposal service or the store where you purchased the product.

## QUICK START

### Quick start oven

Select cooking mode and temperature

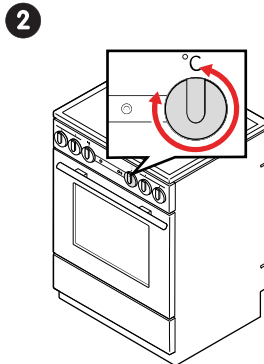
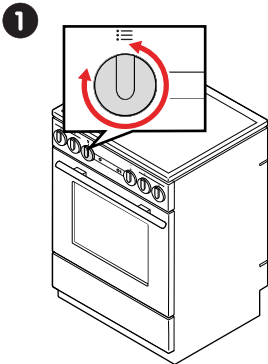

Cooking

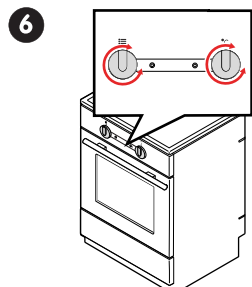
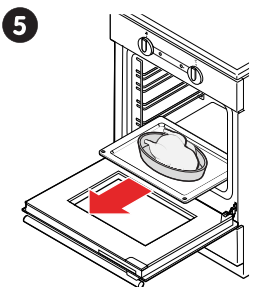
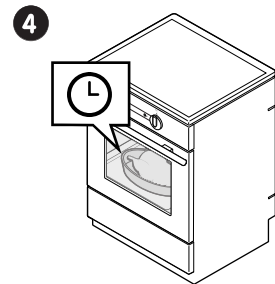
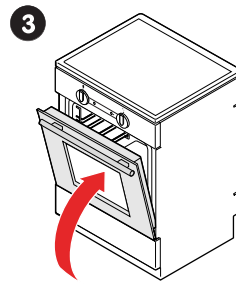
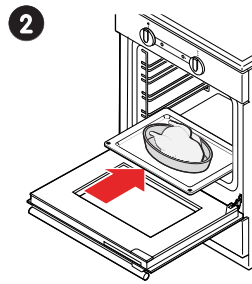
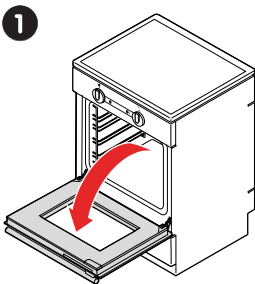

After cooking

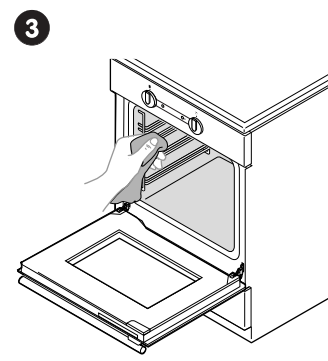
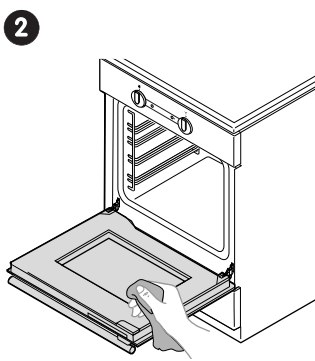
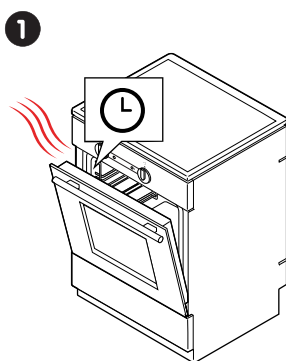

# Quick start hob

## Before cooking

1

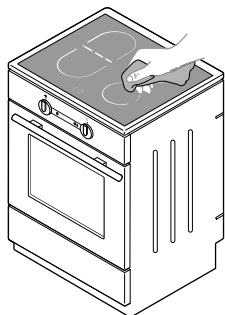

## Cooking

1

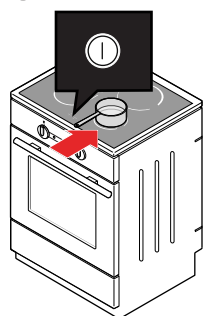

2

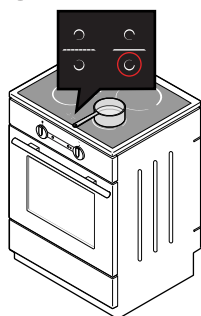

3

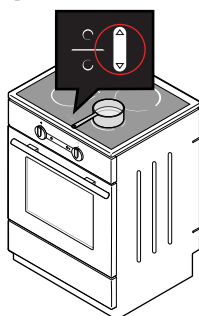

4

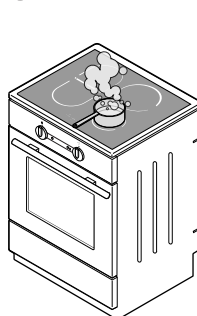

5

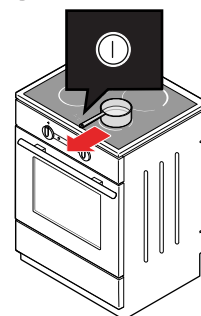

## After cooking

1

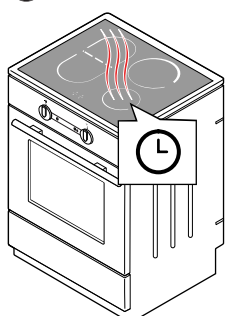

2

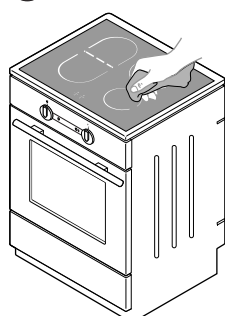

## GETTING STARTED

### Installation

See section "Installation", [page 35](#).

### Before you use the cooker

1. Remove all transport packaging and equipment from the cooker.
2. Clean all accessories and utensils with warm water and regular detergent. Do not use any abrasive cleaners.
3. Clean the hob's glass-ceramic surface it with a damp cloth and some washing-up liquid. Do not use aggressive cleaners, such as abrasive cleaners that could cause scratches, abrasive dishwashing sponges, or stain removers.
4. Heat up the oven without food to 275° C for 60 minutes. Ventilate the room as the cooker will omit the characteristic smell of a new appliance.

**WARNING! Make sure all packaging remnants have been removed from the cooking compartment.**

### Hob overview

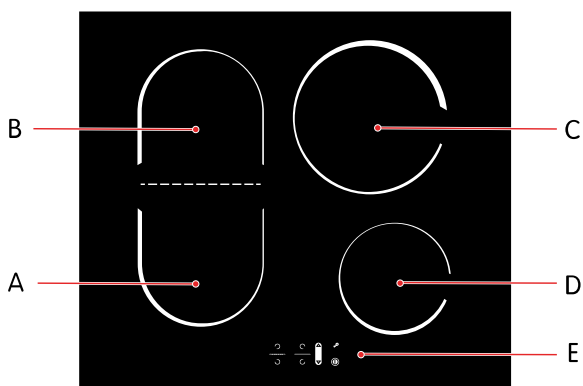

- A. Front left cooking zone
- B. Rear left cooking zone
- C. Rear right cooking zone
- D. Front right cooking zone
- E. Hob control panel

### Hob control panel

Use the touch symbols to control the hob.

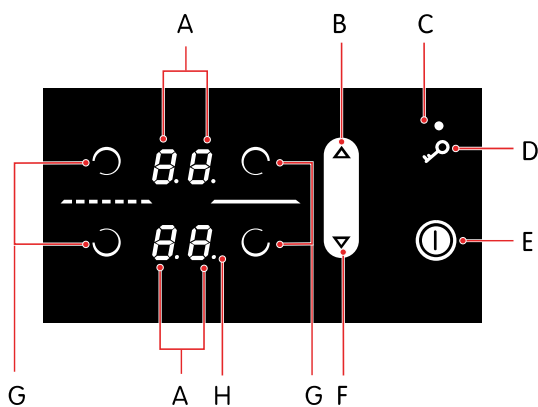

- A. Power level and other individual cooking zone indications (see below)
- B. Increase power and timer
- C. Child lock indication point
- D. Child lock on/off
- E. Hob on/off
- F. Decrease power and timer
- G. Select cooking zone
- H. Timer function indication point

### Possible indications for individual cooking zones



Power level or timer indication.



Power boost is activated. See section "Use power boost", [page 19](#).



The cooking zone is still hot after being turned off. See section "Residual heat indicator", [page 20](#).



There is no cookware on the cooking zone, the cookware is too small, or the cookware material is not suitable for induction hobs. See section "Suitable cookware", [page 17](#).



An object or spilt liquid is covering the control panel.



Two cooking zones are bridged and used as one. See section "Use the bridged cooking zone", [page 20](#).

## Oven controls

Turn the selectors to control the oven.

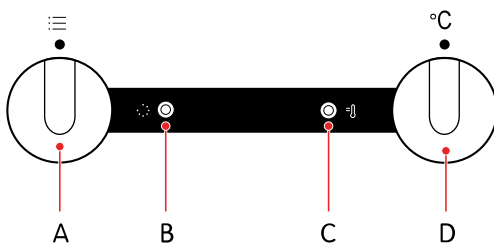

- A. Cooking mode selector
- B. Operation indicator light (yellow)
- C. Temperature indicator light (red)
- D. Temperature selector

### Lights

The operation indicator light is on when the oven or one of the hobs are on. The temperature indicator light turns on when the oven heats up and turns off when the oven has reached the selected temperature.

## Open the child lock

The oven door locks automatically when you close it.

1. Push the child lock gently to the right with your thumb.
2. Pull the oven door while still pushing the child lock.

## Accessories

The cooker is supplied with some useful accessories to improve your cooking experience.

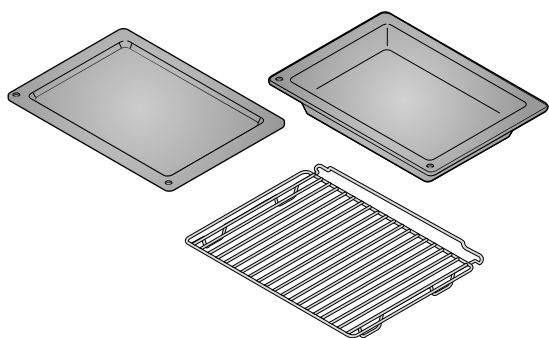

**Shallow trays**

For baking pastries or as a drip tray.

**Extra deep tray**

For roasting large amounts of vegetables and meat or preserving food.

**Grid**

For grilling meat or fish.



# COOKING WITH THE HOB

## Hob overview

### Hob surface

The hob surface is made of a solid glass-ceramic material. Here is some advice on how to use and maintain the surface.

- The surface is very resistant to temperature changes but can be damaged by falling, heavy objects. The surface might break immediately or a while after being hit.

**WARNING!**

If the surface breaks, immediately disconnect the product from the mains. Do not use the product.

- Make sure the cooking zone and the bottom of the cookware are clean and dry to improve performance and prevent surface damage.

**CAUTION!**

If sugar, or food with high sugar content, is spilled over the surface when it is hot - immediately use a wipe or a scraper to remove the sugar from the hot surface. Otherwise the surface might become damaged.

Never use detergents or other cleaners to clean a hot surface.

- Do not use the hob as a storage area as it may result in scratches or damages.
- Do not use aluminium or plastic cookware on hot cooking zones.
- Do not place any plastic objects or aluminium foil on the hob.

### Hob operating principle

Your hob is operating by the principle of induction. This means that heat is produced directly in the bottom of the cookware and that the hob surface is heated only indirectly when the cookware gets hot. No heat is generated if you turn on a cooking zone when there is no cookware placed on the zone. For induction to function, the bottom of the cookware must be made of a ferromagnetic material.

### Suitable cookware

Make sure your cookware is suitable for induction heating.

**WARNING!**

Do not insert equipment between the cooking zone and the bottom of the cookware, for example equipment that makes it possible to use non-magnetic cookware. Use of such equipment may cause burns and damage on the cooker.

Consider the following aspects when choosing cookware for your induction hob.

- Examples of suitable cookware are cookware made of steel, enamel-coated steel pans, and cast iron pans. If you are uncertain, attach a magnet to the bottom of the cookware. If the magnet sticks, the cookware is made of ferromagnetic material and therefore suitable for an induction hob.
- Only use cookware with a flat bottom. Concave or convex bottoms, whether intended or not, may affect the heating process and damage the hob surface and the cookware.
- The cookware must have a thick bottom of at least 2.25 mm.
- Minimum cookware diameter depends on the cooking zone diameter:

Cooking zone diameter	Minimum cookware diameter
145 mm	90 mm
180 mm	110 mm
210 mm	130 mm



**When purchasing cookware, note that the indicated diameter usually refers to the upper edge or the lid, which is normally larger than the diameter of the bottom.**

Examples of unsuitable cookware are cookware made of alloy steel with a copper or aluminium bottom, and glass cookware. The warranty does not cover damage on the cooker caused by the use of unsuitable cookware.

## Basic hob operation







### Turn on the hob

Before you turn on the hob, wipe off any dust or stains from the hob and make sure that the bottom of the cookware is clean. This helps you avoid scratches and burnt-in impurities on the surface of the hob.

1. Touch  and hold for 1 second to turn on the hob.  
If you do not turn on a cooking zone within 10 seconds, the hob is turned off.





When the cooker is connected to the mains for the first time, or after a power failure, the child lock is activated.

### Turn on a cooking zone

1. Place the cookware in the centre of the selected cooking zone.
2. Touch  for cooking zone you want to use.
3. Touch  or  to select power level.  
Touch  first to start at power level 9.  
To change the power level faster, touch and hold  or .

If the display alternates between  and the set power level, the bottom of the cookware is too small, or there is no cookware on the cooking zone. If you place cookware of an appropriate size on the cooking zone within 10 seconds, heating will start at the set power level. If not, the cooking zone is turned off.

### Turn off a cooking zone

1. Touch  for the cooking zone to turn off.
2. Touch  repeatedly to select power level 0.  
You can also touch  and  at the same time to turn off the cooking zone immediately.



#### **WARNING!**

After use, always turn off the cooking zone using the touch controls. If you remove the cookware, the cooking zone is turned off automatically, but do not rely on this.

If all cooking zones are set to power level 0, the hob will turn off automatically after a few seconds.

### Hob power levels



Select the power level best suited for what you want to do.

Here are some examples of how to use the different power levels.

Power level	Use for
0	Use only remaining heat.
1-2	Keep food warm. Slowly simmer small quantities of food.
3	Slowly simmer.
4-5	Slowly cook larger quantities. Roast larger chunks.
6	Roast or brown.
7-8	Roast.
9	Cook large quantities. Sear or braise.
P (power boost)	Start the cooking process. Heat large quantities of water. Cook very large quantities of food.

## Turn off the hob

Turn off the hob immediately after use.

- Do one of the following:
  - Touch  and hold for one second.
  - Set the power level to  for all cooking zones. The hob will turn off automatically after a few seconds.



### NOTE!

After each use of your hob, after it has cooled down, make sure to clean the surface. This prevents impurities to burn into the hot surface at next use.





## Use power boost

Use power boost to quickly boil water or heat the frying pan.



### WARNING!

Do not leave the cooker unattended while using power boost. Power boost is extremely powerful.

- Touch  for cooking zone you want to use.
- Select power level 9.
- Touch  once.  
 appears on the display.
- Touch  to change power level back to 9.

Power boost deactivates automatically after 10 minutes and the power level returns to level 9.

## Save energy

Here are some tips on how you can save energy.





- Use cookware that fits the amount of food you are cooking. The hob automatically adjusts the power to the size of the cookware. Using larger cookware than required consumes more energy.
- When possible, cover the cookware with a lid.
- If a dish takes long time to cook, use a pressure cooker.
- Vegetables, potatoes, and so on, may be cooked in a smaller amount of water. The food will cook just as well, as long as the cookware is tightly closed with a lid. After bringing the water to a boil, reduce the heat to a level that just suffices to maintain a slow simmer.

## Additional hob features

### Use the bridged cooking zone

Combine two cooking zones into one large cooking zone and use it for example when cooking with a large oval pan or a griddle.

Use cookware with a size up to 40 x 25 cm. A heavy-bottom pan distributes the heat more evenly.

1. Place the cookware on the two cooking zones on the left.  
Make sure it does not cover the control panel.
2. Touch  to turn on the hob.
3. Touch  for the two cooking zones on the left at the same time, and hold for 3 seconds.  
 is displayed for the rear left cooking zone.
4. Set the power level with  and .

**NOTE! You cannot use Power boost for the bridged cooking zone.**

From now on, control the bridged cooking zone with  for the front left cooking zone.

Turn off the bridged cooking zone by reducing the power level to 0. Both cooking zones now operate independently.

### Automatic hob power-off

If you place an object or spill liquid over the touch symbols, the hob will be turned off after 10 seconds.

 flashes on the display for all cooking zones and an acoustic signal sounds. The acoustic signal stops when you remove the object or wipe up the spilt liquid.

### Automatic cooking zone power-off

If you do not change the power level for a cooking zone, it is automatically turned off after 10 hours for power level 1-8, and after 3 hours for power level 9.

### Residual heat indicator

The cooking zone is indirectly heated by the heated cookware and stays hot for a while even after it is turned off. Use the residual heat to keep the food warm, or for defrosting.

Residual heat is indicated by  on the display but even after  disappears, the cooking zone may be hot!







#### WARNING!



There is a risk of burns from residual heat.

### Use the child lock

Use the child lock to prevent accidental operation of the hob.

- When the hob is off, all touch symbols except  are locked.
- When the hob is on, all touch symbols except  and  are locked. The hob can still be turned off using .

#### Turn on the child lock







1. Touch  and hold for 1 second.  
When  is lit, the child lock is activated.
2. To turn off the child lock, touch  again and hold for 1 second.

When the cooker is connected to the mains for the first time, or after a power failure, the child lock is activated.

### Use the timer

Use the timer to set the cooking time for any cooking zone independently. When the time expires the cooking zone is turned off and an acoustic signal sounds.





**Turn on the timer**

1. Turn on the cooking zone and set the power level.
2. Touch  for the cooking zone again.  
 is displayed and the set time is displayed on the opposite two cooking zone displays.
3. Touch  or  to set the timer value in minutes from 1 to 99.  
Hold  or  to change the value faster.  
The countdown starts automatically when the value is set. After a few seconds, the display returns to displaying the power levels and the active timer is indicated by a decimal point next to the power value.



When the time expires, an acoustic alarm sounds and the cooking zone is turned off. Turn off the alarm by touching any key. If no key is touched, the alarm is turned off automatically after 2 minutes.

**Turn off the timer**

To turn off the timer before the cooking time expires.

1. Touch  twice for the relevant cooking zone.
2. Decrease the cooking time to 0 using  or touch both  and  at the same time to reach 0 immediately.  
The timer is turned off after a few seconds.

**Display and change the remaining cooking time**

1. Touch  twice for the relevant cooking zone.  
The remaining cooking time is displayed.
2. Touch  or  to increase or decrease the cooking time.

## COOKING WITH THE OVEN

- Use dark, black silicon coated or enamel coated baking trays. They transmit heat better.
- Cooking many types of pastries one after another saves energy since the oven is already hot. Heating an oven that has cooled down uses more energy.
- Steam can sometimes form on the inside of the oven during cooking. The steam may condense on the door and the lid of the cooker. This is normal behaviour and does not affect the operation of the cooker. Wipe of any condensed water with a cloth.
- If you leave the dish in the oven after it has finished cooking steam may evaporate from it and condense on the front panel and the oven door.



**You can turn off the oven about 10 minutes before the end of the cooking process. This will save energy as the already built up heat is used.**

## Cooking modes

### FastPreheat



Use this oven mode to heat the oven to the desired temperature as quickly as possible. Do not use this mode for cooking. Recommended temperature: 50-275 °C.

### Top and bottom heater



Use this oven mode to cook meat or pastry that can only be baked or roasted at a single height level. The top and bottom heaters will radiate heat evenly in the oven. Recommended temperature: 200 °C.

### Bottom heater and fan



Use this oven mode to bake leavened but low-rising pastry or to preserve fruit and vegetables. Use the second guide from the bottom and a shallow baking tray to allow the hot air to circulate across the upper side of the dish. Recommended temperature: 180 °C.

### Grill



Use this oven mode to grill small amounts of open sandwiches, beer sausages or to toast bread. Only the grill heater is on when using this mode. Recommended temperature: 230 °C.

### Large grill



Use this oven mode to grill small amounts of open sandwiches, beer sausages, meat or to toast bread. The grill heat and the upper heater are both on when using this mode. Recommended temperature: 230 °C.

## Grill with fan



Use this oven mode to:

- grill meat, fish and vegetables
- roast larger chunks of meat or poultry at a single height level
- make dishes au gratin
- brown food to a crispy crust

The grill heater and the fan are on at the same time when using this mode. Recommended temperature: 170 °C.

## Hot air



Use this oven mode to roast meat or bake pastries on several levels at the same time. The round heater and the fan will make sure that hot air constantly circulates around the food. Recommended temperature: 180 °C.

## Hot air and bottom heater



Use this oven mode to bake:

- pizzas
- apple pies
- fruitcakes
- moist pastry
- leavened dough
- shortcrust

The bottom heater, round heater and the fan will make sure that hot air constantly circulates around the food. Recommended temperature: 200 °C.

## GentleBake



Use this oven mode to roast meat, cook fish or bake pastries on a single rack. It provides a gentle, slow, and even baking that leaves the food soft and juicy. Recommended temperature: 180 °C.

## Defrost



Use this oven mode to defrost food such as:

- cakes with heavy cream or butter-based cream
- cakes and pastry
- bread and rolls
- deep-frozen fruit

Remove the food from its packaging in most cases.



### NOTE!

Remove any metal clamps or clips.

Turn over, stir and separate any pieces frozen together halfway through the defrost time.

In the defrost mode, the fan circulates the air with no heaters activated. This is used to slowly thaw frozen food.

### WaterClean



Use this oven mode to remove stains and food residues from the oven. Only the bottom heater will radiate heat. The programme takes 30 minutes. Recommended temperature: 70 °C.

### Turn on and off the oven

1. Turn the oven mode selector to any of the cooking modes to turn it on.
2. Turn the oven mode selector to 0 to turn it off.

### Change oven temperature

Select a suitable temperature for what you are cooking.

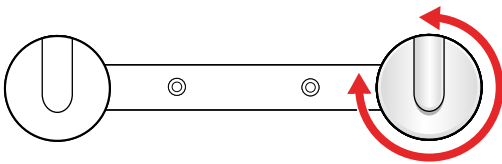

1. Turn the temperature selector clockwise to increase the temperature or anticlockwise to lower the temperature.  
**CAUTION! Do not turn the selector below the zero position. This can damage the thermostat.**  
 The temperature range is 50-275 °C.

### Change oven cooking mode

Select the suitable cooking mode for what you are cooking.

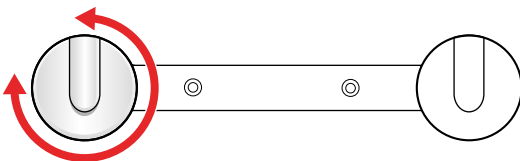

1. Turn the cooking mode selector clockwise or anticlockwise to switch between the available modes.















**The cooking mode can also be changed during cooking.**

### Oven cooking mode guide

Find the most suitable oven cooking mode for your needs by using the following table.

Cooking method	Food type	Oven cooking mode
Roast	Meat	
	Meat, Poultry	



Cooking method	Food type	Oven cooking mode
Grill	Open sandwiches, beer sausages	
	Open sandwiches, beer sausages, meat	
	Meat, fish, vegetables	
Brown		
Bake	Pastries on a single level, fish	
	Pastries on a single level	
	Pastries on multiple levels	
	Pizzas, apple pies, fruitcakes, moist pastries, leavened dough, shortcrust	
	Leavened but low-rising pastries	
Au gratin		
Toast	Bread	
		
Preserve	Fruit, vegetables	

## Wire guides

Wire guides allow you to choose between 4 different levels when you insert a grid or a tray into the oven. The levels/guides are counted from the bottom and up.

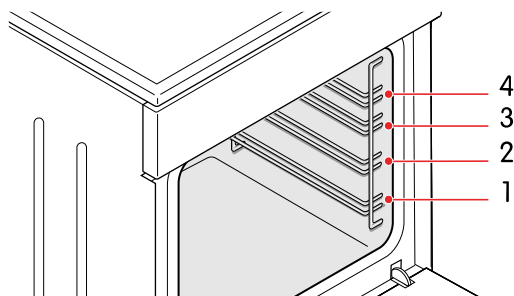

The oven is safe to use both with and without the guides.



### CAUTION!

Do not place baking trays or other cookware on the bottom of the oven.

## Pre-heat the oven

Use the FastPreheat mode to quickly heat the oven to the temperature that you want.



### NOTE!

This mode is not suitable for cooking.

1. Turn the cooking mode selector to .
2. Turn the temperature selector to the desired temperature.

## Grilling recommendations

Use these recommendations when grilling.



### WARNING!

Only use the grill with the oven door closed.



### WARNING!

Use oven mitts or meat tongs. The grill heater, grid, and other oven accessories get very hot during grilling.

- Preheat the grill for about 5 minutes before you use it.
- Observe the food regularly. The food may burn quickly because of the high temperature.
- Smear the grid with oil to prevent the meat from sticking when grilling directly on it. Use the 4th guide.
- Insert the drip tray in to the 1st or 2nd guide.
- Make sure there is enough liquid in the tray when using a baking tray. Otherwise the food may burn.
- Turn the meat.
- Clean the oven, the accessories, and the utensils when you have finished grilling.

## Roasting recommendations

Use these recommendations when roasting.

- Use enamel coated, tempered glass, clay, or a cast iron pan or tray.



### NOTE!

Do not use stainless steel trays. They strongly reflect heat.

- Use enough liquid when cooking to prevent the meat from burning.
- Cover the meat to keep it juicy.

## Baking recommendations

Use these recommendations when baking.

- Preheating is recommended.
- You can bake biscuits and cookies in shallow baking sheets on several levels (second and third) at the same time.



### NOTE!

The biscuits or cookies on the upper baking sheet may be ready sooner than the ones on the lower one.

- Always place the baking trays on the grid. Remove the grid if you are using the supplied baking sheet.



### CAUTION!

Do not insert the deep baking tray into the first guide.

- Make biscuits of similar thickness to make sure that they brown evenly.
- Baking accessories may change form as they get hot. This does not affect their functions and they will return to their original form when they cool down.

## Preserve food

Use your oven to preserve food.

1. Turn on the oven and select oven mode .
2. Pour 1 litre hot water (about 70 °C) on the deep tray.
3. Place 6 one-litre jars on the deep tray.
4. Insert the deep tray into the oven on the second guide from the bottom.
5. Close the oven door.

Observe the food during cooking and take it out when the liquid in one of the jars begin to simmer.

## CLEANING

Make sure to clean your product regularly to make it last longer and keep a good appearance.



### WARNING!

Do not let children clean the product without supervision.



### WARNING!

Risk of electric shock!

- Before cleaning, disconnect the product from the mains.
- Do not use steam cleaners or high pressure cleaners to clean the product, as this may result in electric shock.



### CAUTION!

Always wait for the product to cool down before cleaning.

## Clean the hob surface

Always clean your hob's glass-ceramic surface in the correct way to ensure long lasting operation and appearance.



### CAUTION!

- Do not use steel wool, coarse cleaning sponges, or abrasive powder as they may scratch the surface. Aggressive spray cleaners, descaling agents, and other unsuitable liquid cleaners may also damage the surface.
- After cleaning, make sure to thoroughly remove any cleaner residue from the surface, since it may damage the surface when you heat up the cooking zones next time.



### CAUTION!

If sugar, or food with high sugar content, is spilled over the surface when it is hot - immediately use a wipe or a scraper to remove the sugar from the hot surface. Otherwise the surface might become damaged.

Never use detergents or other cleaners to clean a hot surface.

- When cleaning the hob, use special care products that create a protective film that prevents dirt from sticking to the surface.
- Remove minor impurities with a damp, soft cloth and wipe the surface dry.
- Remove water stains with a mild solution of vinegar. Make sure not to use this solution on the frame as it may lose its shine.
- For stubborn dirt, use special glass-ceramic cleaners and follow the manufacturer's instructions. If nothing else works, remove stubborn dirt with a scraper. Hold the scraper at the correct angle (45° to 60°), gently press the scraper against the glass and slide it to remove the dirt.

Discolouration of the glass-ceramic surface is usually a result of food residues being burnt onto the surface or from using cookware of unsuitable material (like aluminium or copper). Such discolouration is very difficult to remove completely but does not affect the function of the hob and is therefore not covered by the warranty.

## Clean glass surfaces

Clean glass surfaces with equipment and agents intended for cleaning glass, mirrors, and windows.



### CAUTION!

Do not use rough abrasive cleaners or sharp metal scrapers as they could crack the surface and cause the glass to break.

## Clean stainless steel surfaces

Clean stainless steel surfaces with a mild detergent and a soft sponge that will not scratch the surface.

**CAUTION!**

Do not use abrasive cleaners or cleaners containing solvents as they may damage the surface.

## Clean enamel surfaces

Clean enamel surfaces with a damp sponge. Remove fatty stains with warm water and special detergent for enamel.

**CAUTION!**

Do not clean enamel surfaces with abrasive cleaners or tools as they may cause permanent damage.

## Clean plastic parts and lacquer-coated surfaces

Immediately remove any stains on plastic parts and lacquer-coated surfaces with a soft non-abrasive cloth and some water. You may also use cleaners and cleaning tools intended for plastic and lacquer-coated surfaces. Follow the manufacturer's instructions.

**CAUTION!**

Do not use abrasive cleaners, abrasive tools, or alcohol-based cleaners.

## Clean the oven

Clean the oven cavity regularly.

**CAUTION!**

Do not lean against the open door when cleaning the oven cavity. Never stand on the open oven door and do not let children sit on it. The oven door hinges may be damaged under excessive load.

**CAUTION!**

Do not use abrasive agents. They will scratch enamel coated surfaces.

- Clean the oven walls with a damp sponge and detergent. Use a special enamel detergent for burned stains.
- Wipe the oven dry carefully after cleaning it.
- Clean the wire guides and telescopic guides using a conventional detergent.

**CAUTION!**

Do not clean the telescopic guides in a dishwasher.

- Clean the oven utensils with a sponge and detergent. You can use special detergents for rough stains or burns.

## Use the WaterClean programme

Use the WaterClean programme to easily remove stains and food residues from your oven.

**CAUTION!**

Make sure the oven has cooled down before you start the WaterClean programme.

1. Turn the cooking mode selector to .
2. Turn the temperature selector to 70 °C.
3. Pour 0.6 l water into a baking tray and place it in the lower guide.
4. Let the programme run for 30 minutes. The food residues will soften.
5. Clean the oven enamel walls with a damp cloth.

## TROUBLESHOOTING

You can solve many minor problems with help from the troubleshooting information. If the problem persists, do not try to repair the product in other ways than mentioned in this manual.



### WARNING!

Risk of electric shock!

- Do not attempt to perform any repairs yourself. Tampering with the product and non-professional repair may cause injury or damage to the product. It also makes the warranty invalid. Instead, contact a service technician.
- Do not replace the power cord yourself. If the power cord is damaged, it must be replaced by the manufacturer or authorised technicians to avoid hazard.









## General troubleshooting

Use this table to solve general problems with your cooker.

Problem	Solution
The main fuse in your home trips often.	Make sure the power of all switched-on appliances does not exceed the capacity of the power mains in your home. Contact a service technician.

## Hob troubleshooting

Use this table to solve problems with your hob. See also section "Normal noise during cooking with the hob", [page 31](#).

Problem	Cause	Solution
The display is frozen and the touch symbols does not work.		Disconnect the product from the mains power for a few minutes. Then reconnect the product and turn it on.
 is flashing on the display after turning on a cooking zone.	The cookware is not suitable for induction hobs. The cookware is too small.	Use cookware with a ferromagnetic bottom of the right size. See section "Suitable cookware", <a href="#">page 17</a> . If  continues to flash after turning the hob off and on, disconnect the appliance from the mains, wait for 5 minutes and reconnect it.
 is displayed	The hob is overheated.	Wait for the hob to cool down. Use a lower power setting and make sure the cookware is not empty.
 is displayed	An error has occurred during operation.	
 is displayed	The desired power level cannot be set because the maximum total power for the hob has been reached.	
 is flashing on the display.	An object is placed or liquid spilt over the touch symbols on the control panel.	Remove the object or wipe the control panel clean.
  is displayed	Unsuitable cookware without ferromagnetic properties.	Use cookware with a ferromagnetic bottom of the right size. See section "Suitable cookware", <a href="#">page 17</a> .

Problem	Cause	Solution
The power boost function is turned off automatically.	The power boost function is always turned off automatically after 10 minutes.	Reactivate the power boost function. If necessary turn off the cooking zone and turn it back on before reactivating power boost.
	The power boost function is turned off if the cooking zone is overheated.	Wait for the cooking zone to cool down before reactivating the power boost function.
<b>E r</b> or <b>E</b> + other number than <b>E</b> is displayed	An error in the electronic circuits.	Disconnect the appliance from the mains, wait 5 minutes and reconnect it. If the error is displayed again, call a service technician.

## Normal noise during cooking with the hob

It is normal that the induction hob and the cookware make some noise during cooking.

Type of noise	Description
Noise caused by induction	Induction causes molecules in the cookware to oscillate. This can cause more or less noise depending on the cookware material.
Transformer-like buzz	Occurs when cooking at high power levels.
Vibrations and crackling of the cookware	Noise occurs when the cookware gets heated and depends on the cookware material and the amount and type of food being cooked.
Fan noise	A fan is activated when the cooker gets hot inside. The fan may operate for a while even after the hob has been turned off.



**NOTE!**

In case of operation failure, disconnect the cooker from the mains, wait a few minutes and connect again. If the problem persists, contact a service technician.

## Oven troubleshooting

Use this table to solve problems with your oven.

Problem	Solution
The oven lighting does not work.	section "Replace the oven light bulb", <a href="#">page 32</a>
The food is undercooked.	Make sure you have selected the right temperature and cooking mode. Make sure the oven door is closed.

## Replacing parts

### Replace the oven light bulb

When the light bulb breaks, replace it with a halogen light bulb G9, 25 W.



**WARNING!**

Risk of electric shock! Before replacing the light bulb always disconnect the product from the mains.



**NOTE!**

The light bulb is not covered by warranty because it is a consumable item.

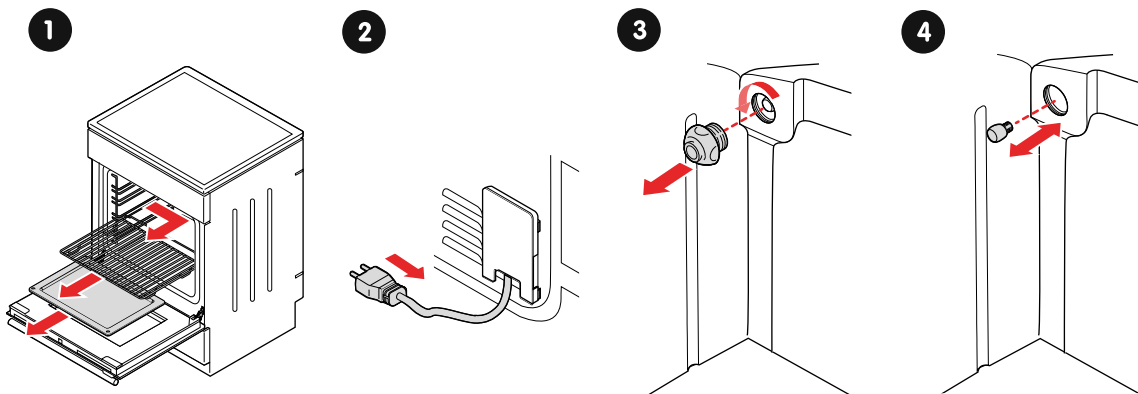

1. Remove the grid, guides and trays.
2. Disconnect the cooker from the mains power.
3. Remove the bulb cover.
4. Replace the bulb.  
**WARNING! Use protection when you remove the old light bulb to avoid burning yourself.**  
**CAUTION! Do not damage the enamel surface.**
5. Install the cover.
6. Connect to cooker to the mains power.

### Replace the oven door

Remove and replace the oven door if it is broken or if you need to remove the oven door glass pane.

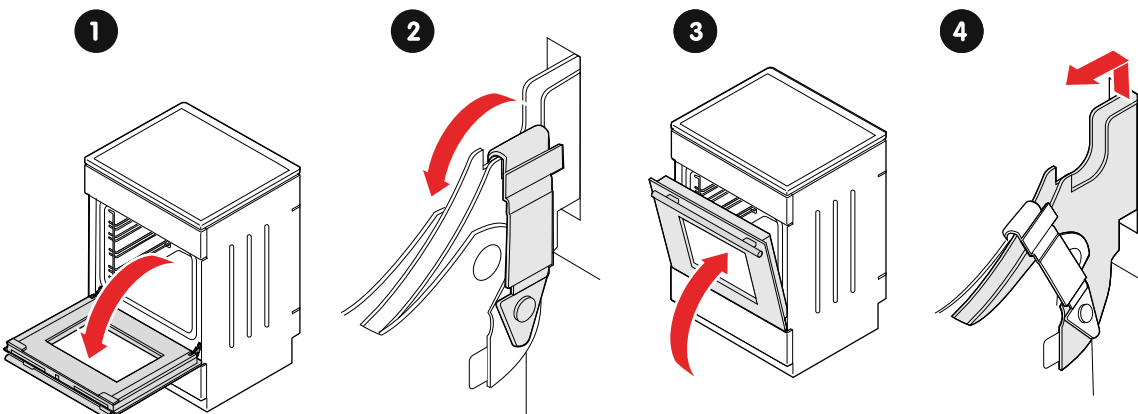



1. Open the oven door fully.
2. Raise up and fold the latches of the door hinges.
3. Fold the door gently to an angle of about 15°.
4. Remove the door: pull out the hinges from the openings.

Install in the reverse order.



**CAUTION!**

Make sure the hinges are correctly positioned in their hooks. Otherwise the door may not open and close properly.

**Remove and install the oven door glass panes**

Remove the oven door glass pane if it is broken or if you want to clean it.

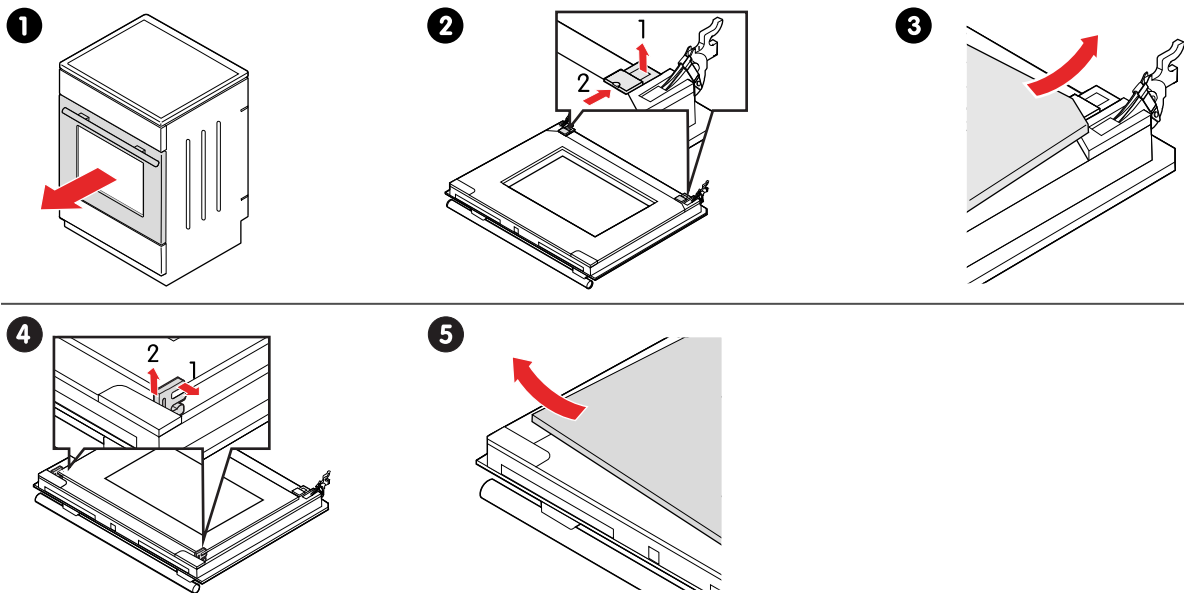

1. Remove the oven door from the appliance.
2. Lift the supports a little and pull them off the glass.
3. Lift up the lower end of the glass pane and remove it.
4. Turn the rubber holders a little and pull them off from the remaining glass pane.
5. Lift up the upper end of the remaining glass pane and remove it.

Install in the reverse order.



**NOTE!**

The markings (semicircle) on the door and the glass pane should overlap.

**Remove and install the wire guides**

Use this procedure to remove and install the wire guides.

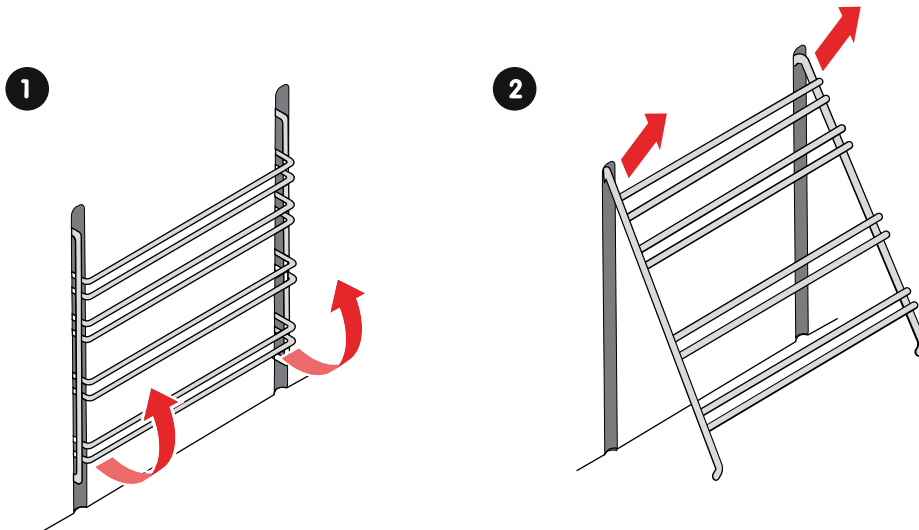

1. Pull the bottom side of the guides out from the oven wall.
2. Pull out the guides from the holes at the upper side.

Install the guides in the reverse order.

# INSTALLATION

## Cooker placement

Make sure to place the oven considering the measurements and other factors described in this section.

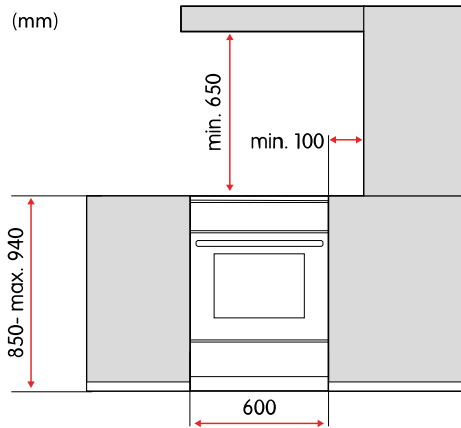

**WARNING!**  
Risk of fire!

- Make sure the floor and the adjacent walls are temperature resistant to at least 90 °C.
- Do not install the oven behind a decorative door, as it may become overheated.



**WARNING!**

The oven is intended to be placed directly on the floor, without any support or plinths.



**CAUTION!**

Do not install the oven near powerful heat sources, such as solid fuel stoves, as the high temperature may damage the oven.

## Secure the cooker to a wall

Securing the cooker to a wall will prevent it from tipping over.

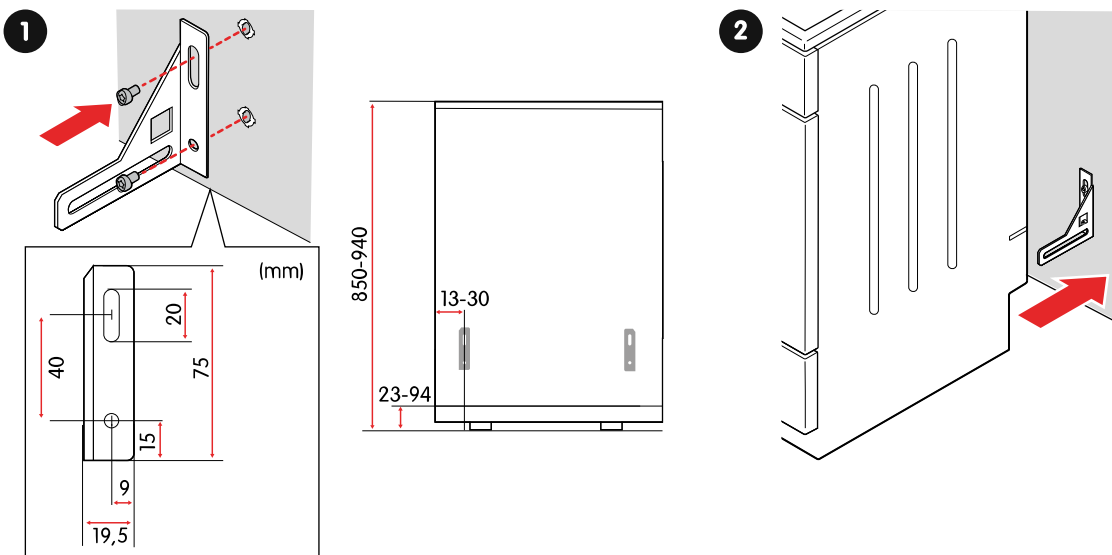

1. Fasten the bracket to the wall using the supplied screws and anchors.  
**WARNING! If the supplied screws or anchors are not suitable for the wall, make sure you use ones that will ensure a secure installation on the wall.**
2. Position the cooker to the bracket and fasten it.

## Adjust the height of the cooker

You can adjust the height of the cooker from 850 mm to 940 mm.

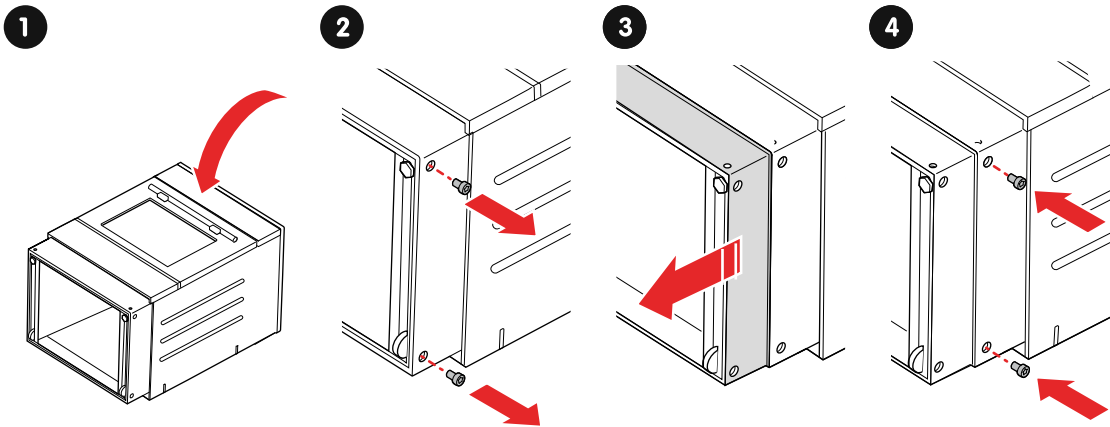

1. Lay the cooker down on the floor on its back.
2. Unscrew the screws.
3. Adjust the height.
4. Screw the screws back in.

## Level the cooker

Level your cooker by adjusting the height of the the front feet and the rear wheels individually.



### WARNING!

The cooker must be installed horizontally levelled.

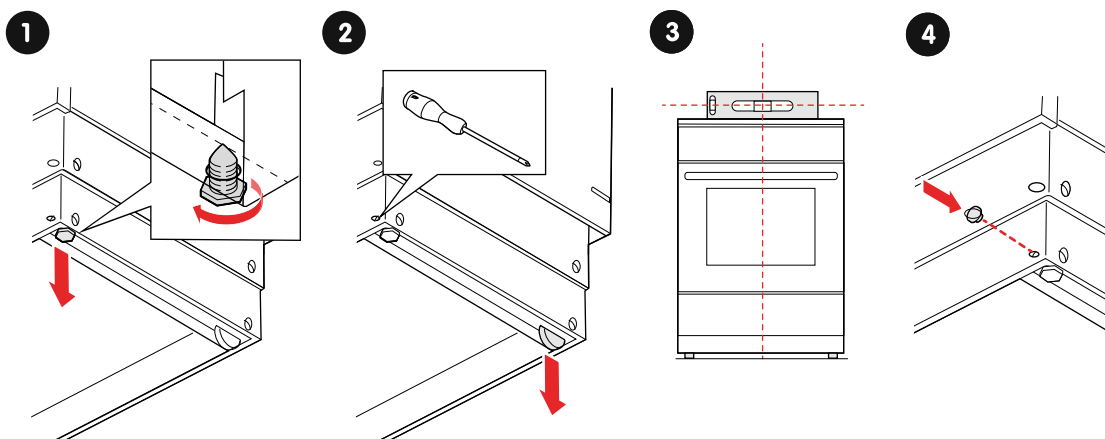

1. Turn the front feet to adjust the height.
2. Turn the wheel adjustment screws to adjust the height of the rear wheels.
3. Place a spirit level on top of the cooker to check the horizontal position. Adjust if needed.
4. Place the blind plugs into the holes.

## Connect the mains power

Connect the cooker to either a single-phase or a three-phase power supply.



**WARNING!**

Risk of electric shock! Do not connect the product to the mains yourself. The product may only be connected by an authorised technician.



**WARNING!**

- The electrical installation must follow local regulations.
- For single-phase power supply, use a 3×4.0 mm<sup>2</sup> cord marked H05VV-F 3G4 or better.
- For three-phase power supply, use a 5×1.5 mm<sup>2</sup> cord marked H05VV-F 5G1.5 or better.
- Do not use external timers or separate remote control systems to control the product.



**CAUTION!**

Carefully read the instructions for use before connecting the appliance. Repair or any warranty claim resulting from incorrect connection or use of the product shall not be covered by the warranty.

### Connect to a single-phase power supply

Follow these instructions to connect the cooker to a 220-240 V, 50-60 Hz, single phase power supply.

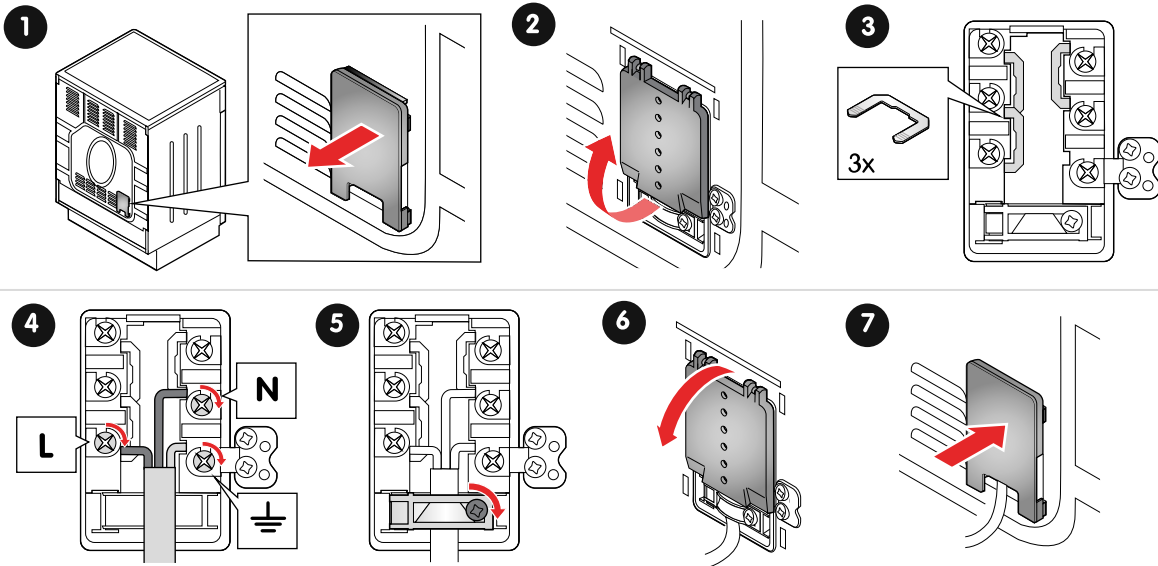

1. Remove the clamp protection cover.
2. Open the terminal board cover.
3. Install the bridges.
4. Secure the cable wires to the terminal board using the screws.  
**WARNING! Make sure the protective earth wire is properly secured.**
5. Secure the cable with the clip.
6. Close the terminal board cover.
7. Install the clamp protection cover.

### Connect to a three-phase power supply

Follow these instructions to connect the cooker to a 380-415 V 3N~, 50 Hz, three phase power supply.

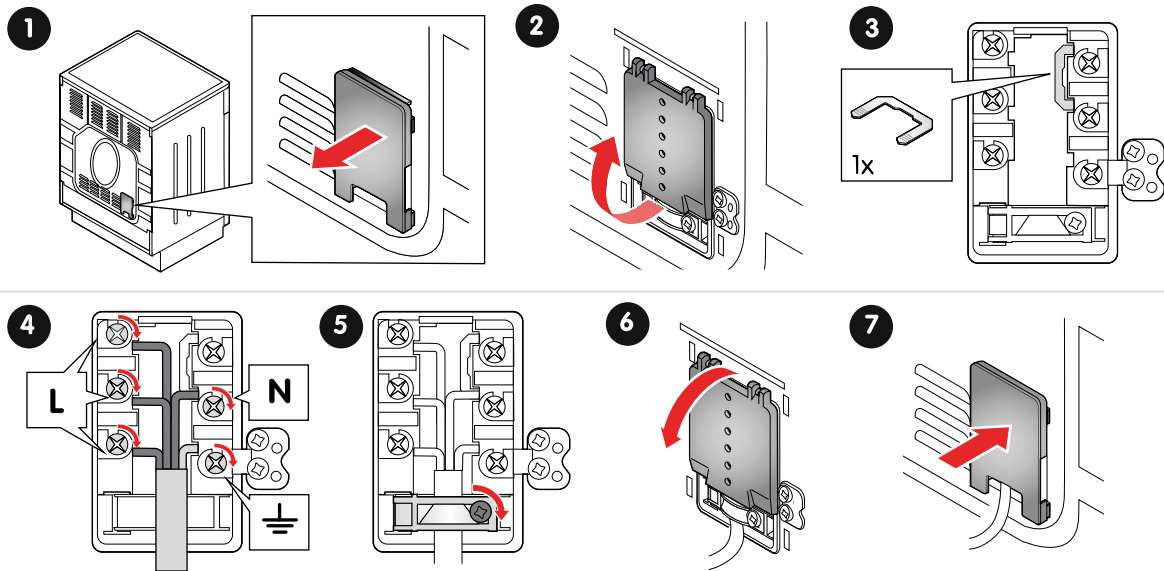





1. Remove the clamp protection cover.
2. Open the terminal board cover.
3. Install the bridge.
4. Secure the cable wires to the terminal board using the screws.  
**WARNING! Make sure the protective earth wire is properly secured.**
5. Secure the cable with the clip.
6. Close the terminal board cover.
7. Install the clamp protection cover.

**Do the following after the connection is completed**

1. Make sure the mains power has been correctly installed.
2. Check that the heaters, control and governing elements are working correctly.

## Set maximum hob power

Maximum hob power is 7200 W by default. If the available power or the fuse size is limited, set a lower maximum power.

1. Connect the cooker to the mains.
2. Touch  and hold for 1 second to turn off the child lock.
3. Touch  for the rear left and the front right cooking zones simultaneously.  
The current maximum power is displayed.
4. Touch  or  to set the desired maximum power.  
Available power settings are 7200 W, 6000 W, 3500 W, and 2800 W.
5. Touch  for the upper left and the lower right cooking zone at the same time again to store the new setting.

 is displayed on the selected cooking zone when the maximum hob power is reached. Depending on the set maximum power, it may not be possible to use a high power level for several cooking zones at the same time.

## APPENDIX

### Specifications

Product code	CIS56231V
Height	85-94 cm
Width	59.7 cm
Depth	59.8 cm
Weight	48.9 kg
Oven cavity volume	70 l
Power supply	220-240 V, 50-60 Hz 380-415 V 3N~, 50 Hz
Electrical connection rating	10 500 W

Cooking zone	Diameter	Power
Front left	18 cm	2 kW
Rear left	18 cm	2 kW
Rear right	21 cm	2 kW
Front right	14.5 cm	1.6 kW

### EU directives and standards

This product fulfils the applicable EU directives and regulations and carries the CE mark. If not included with the product, a copy of the EU Declaration of Conformity is available on request.

The performance of the product has been tested in compliance with EN 60350-1.

# ELVITA

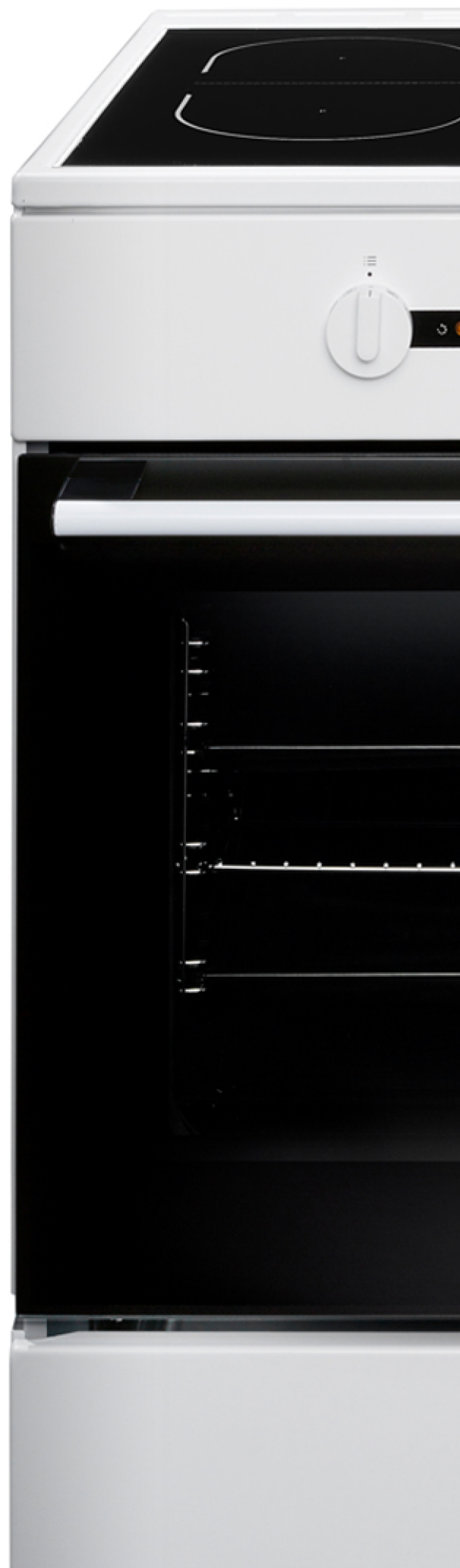

## **elon** GROUP

Elvita products are distributed and marketed by Elon Group AB.  
Elon Group AB Bäcklundavägen 1 | 702 03 Örebro Sweden  
ELON GROUP | +46(0)10-220 40 00 | ELONGROUP.SE  
Support and service: ELVITA.SE