

GRUNDIG

Washing Machine

User Manual



GWPE89E6168WW



Please read this user manual first!

Dear Customer,

Thank you for selecting a Grundig product. We hope that you get the best results from your product which has been manufactured with high quality and state-of-the-art technology. Therefore, please read this entire user manual and all other accompanying documents carefully before using the product.

Follow all warnings and information in the user manual. Thus, you protect yourself and your product against possible dangers.

Keep the user manual. If you hand over the product to someone else, provide the user manual as well. The manual contains warranty conditions, operation and troubleshooting methods for your product.

Explanation of symbols

Throughout this user manual the following symbols are used:



Danger that could result in death or injury.

WARNING Danger that may result in property damage to the product or its environment



Important information or useful hints about usage.



Read the user manual.



Recyclable material.



Hot surface warning.

1 General safety instructions

This section contains safety instructions that will help protect from risk of personal injury or property damage.

Our company shall not be liable for any damages that may arise in case of failure to follow these instructions.

- ▶ Always have the installation and repairing procedures carried out by the Authorized Service Agent.
- ▶ Only use original spare parts and accessories.
- ▶ Unless explicitly stated in the user's manual, do not repair or replace any part of any product.
- ▶ Do not make technical modifications in the product.



1.1 Intended Purpose

- ▶ This product is designed to be used in indoor areas, homes and similar locations. For example;
 - Personnel kitchens of stores, offices and other work environments;
 - Farmhouses;
 - By customers of hotels, motels and other accommodation facilities
 - Bed and breakfasts, hostel-like environments
 - Common areas of apartment blocks or laundries

Use the product only for washing textiles with a machine-washable label attached by the manufacturer. The product is not intended for commercial use.



1.2 Safety of children, vulnerable persons and pets

- ▶ This product can be used by children at and above 8 years old and by persons whose physical, sensory or mental capabilities were not fully developed or who lack experience and knowledge provided that they are supervised or trained on the safe usage of the product and the risks it brings out.
- ▶ Children under the age of 3 should be kept away unless continuously supervised.
- ▶ Electrical products are dangerous for the children. Children or pets should not play with, climb on top or inside the product. Check inside the product before use.
- ▶ Use child lock to prevent children from intervening with the product.

- ▶ Do not forget to close the loading door when leaving the room where the product is located. Children and pets may get locked inside and drown.
- ▶ Children should not perform cleaning and user maintenance works without an adult's supervision.
- ▶ Keep packaging materials away from children. Danger of injury and drowning.
- ▶ Keep all detergents and additives used for the product away from children's reach.
- ▶ Cut the power cable and break and deactivate the locking mechanism of the loading door before disposing of the product for children's safety.

1.3 Electrical safety

- ▶ Product should be unplugged during installation, maintenance, cleaning and repair procedures.
- ▶ If the power cable is damaged, it must be replaced by the authorized service in order to avoid possible risks.
- ▶ Do not tuck the power cable under and behind the product. Do not place heavy objects on the power cable. Do not over bend, crush and touch the power cable to sources of heat.
- ▶ Do not use extension cables, multi sockets or adaptors for powering the product.
- ▶ The plug should be easily accessible. If this is not possible, follow the electricity regulations of the electrical wiring the product is connected to, and there should be a mechanism (fuse, switch, contact breaker, etc.) to separate all poles from the mains.
- ▶ Do not touch the plug with wet hands.
- ▶ Unplug the appliance by holding and pulling the plug, not its cord.
- ▶ Make sure the plug is not wet, dirty or dusty.



1.4 Moving Safety

- ▶ Unplug the product before moving, remove the water outlet and water main connections. Drain any water left inside the product.
- ▶ The product is heavy, do not move alone. Do not hold extruding parts such as the laundry loading door to lift and move the product. The upper tray should be tightly fixed for moving.
- ▶ Your product is heavy; it should be carried carefully by two people if a staircase is involved. It may cause injuries if your product falls on you. Do not hit and drop the product while carrying.

- ▶ Carry the product in an upright position.
- ▶ Make sure that the hoses as well as the power cable are not folded, pinched or crushed after the product is fitted into its place after installation or cleaning procedures.



1.5 Installation Safety

- ▶ Check the information on the manual and installation instructions to prepare the product for installation and make sure the electrical mains, clean water mains and water outlet are suitable. If not, call a qualified electrician and plumber to have them make the necessary arrangements. These operations are the responsibility of the customer.
- ▶ Check for any damages before installing the product. Do not go ahead with the installation if the product is damaged.
- ▶ Injuries may occur if hands are put into uncovered slots. Close the holes of the transportation safety bolts with plastic plugs.
- ▶ Do not install or leave the product at locations where it may be exposed to external environment conditions.
- ▶ Do not install the product at locations where the temperature drops below 0°C.
- ▶ Do not place the product on a carpet or similar surface. It would create fire hazard since it cannot receive air from underneath.
- ▶ Place the product on a clean, even and hard floor and balance with the adjustable feet.
- ▶ Connect the product to a grounding plug protected by a fuse suitable to the current values on the type label. Make sure the grounding is carried out by an expert electrician. Do not use the product without suitable grounding to local/national regulations.
- ▶ Plug the product in a socket with voltage and frequency values suitable to those indicated on the type label.
- ▶ Do not plug the product in loose, displaced, broken, dirty, oily sockets or sockets with risk of water contact.
- ▶ Use the new hose set provided with the product. Do not re-use old hose sets. Do not make additions to the hoses.
- ▶ Connect the water inlet hose directly to the water tap. The pressure from the tap should be minimum 0.1 MPa (1 bar) and maximum 1MPa (10 bars). 10 to 80 litres of water should be running from the tap in a minute in order for the product to function properly. If the water pressure is above 1 MPa (10 Bars), a pressure-reducing valve should be fitted. The maximum allowed temperature is 25°C.

- ▶ Fit the end of the water discharge hose to the dirty water discharge drain, the sink or the bathtub.
- ▶ Place the power cable and houses in locations without risk of tripping.
- ▶ Do not install the product behind a door, a sliding door or at another location that will prevent the door from opening completely.
- ▶ If a drier is to be placed on the product, fix with a suitable connection apparatus obtained from the authorized service.
- ▶ There is a risk of contact with electrical pieces when the upper trays is removed. Do not dismantle the upper tray of the product.
- ▶ Place the product at least 1 cm away from the edges of furniture.



1.6 Usage Safety

- ▶ Only detergents, softeners and additives suitable for washing machines should be used.
- ▶ Never use any chemical solvents in the product. These materials have the risk of explosion.
- ▶ Do not operate defective or damaged products. Unplug the product (or turn off the fuse it is connected to), turn off the water tap and call an authorized service.
- ▶ Do not place sources of ignition (burning candle, cigarettes, etc.) or sources of heat (irons, furnaces, ovens, etc.) on top of or near the product. Do not put inflammable/explosive materials near the product.
- ▶ Do not stand on top of the product.
- ▶ Unplug the product and turn off the tap if you will not be using the product for long periods.
- ▶ Detergent/maintenance materials may splash out of the detergent drawer if it is opened while the machine is working. Contact of the detergent with your skin and eyes is dangerous.
- ▶ Make sure pets do not climb inside the product. Check inside the product before use.
- ▶ Do not force open the locked loading door. The door will open once the washing is completed. If the door does not open, use the solutions for “loading door does not open” error in the Troubleshooting section.
- ▶ Do not wash elements contaminated with gasoline, kerosene, benzene, reducers, alcohol or other inflammable or explosive materials and industrial chemicals.
- ▶ Do not directly use dry cleaning detergent and do not wash, rinse or spin laundry contaminated with dry cleaning detergent.

- ▶ Do not place your hands into the rotating drum. Wait until the drum no longer rotates.
- ▶ Do not place your hand or a metal object under the washing machine.
- ▶ If washing laundry at high temperatures, the discharged washing water could burn your skin if in contact with it. When the discharge hose is connected to the tap. Do not touch the discharge water.
- ▶ Take the following precautions to prevent formation of biofilm and malodours:
 - Make sure the room where the washing machine is placed is well ventilated.
 - Wipe the bellows and loading door glass with a dry and clean cloth at the end of the programme.
- ▶ The glass of the loading door will heat up when washing at high temperatures. Therefore, do not allow especially children to touch the glass part of the loading door during washing.



1.7 Maintenance and cleaning safety

- ▶ Do not wash the product with pressure washers, by spraying vapour, water or pouring water.
- ▶ Do not use sharp and abrasive tools while cleaning the product. Do not use household cleaners, soap, detergent, gas, gasoline, thinner, alcohol, varnish, etc. while cleaning.
- ▶ Cleaning agents containing solvents might reek poisonous fumes, for ex. Cleaning solvent. Do not use cleaning products containing solvents.
- ▶ There may be detergent residues in the detergent drawer when you open it for cleaning.
- ▶ Do not dismantle the filter of the discharge pump while the product is running.
- ▶ The temperature in the machine may rise up to 90°C. Clean the filter after the water in the machine cools down in order to avoid risk of getting burnt.

2 Important instructions for environment

2.1 Compliance with WEEE Directive

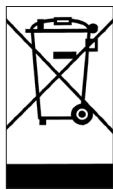

This product complies with EU WEEE Directive (2012/19/EU). This product bears a classification symbol for waste electrical and electronic equipment (WEEE).

This product has been manufactured with high quality parts and materials which can be reused and are suitable for recycling. Do not dispose of the waste product with normal domestic and other wastes at the end of its service life. Take it to the collection center for the recycling of electrical and electronic equipment. Please consult your local authorities to learn about these collection centers.

Compliance with RoHS Directive:

The product you have purchased complies with EU RoHS Directive (2011/65/EU). It does not contain harmful and prohibited materials specified in the Directive.

2.2 Package information

Packaging materials of the product are manufactured from recyclable materials in accordance with our National Environment Regulations. Do not dispose of the packaging materials together with the domestic or other wastes. Take them to the packaging material collection points designated by the local authorities.

3 Intended use

- This product has been designed for domestic use. It is not for commercial purposes or it should not be used out of its intended use.
- The product must only be used for washing and rinsing of laundry that are marked accordingly.
- The manufacturer waives any responsibility arisen from incorrect usage or transportation.
- The service life of your product is 10 years. During this period, original spare parts will be available to operate the appliance properly.
- This appliance is intended to be used in household and similar applications such as:
 - staff kitchen areas in shops, offices and other working environments;
 - farm houses;
 - by clients in hotels, motels and other residential type environments;
 - bed and breakfast type environments;
 - areas for communal use in blocks of flats or in launderettes.

4 Technical specifications

Supplier name or trademark	GRUNDIG
Model name	GWPE89E6168WW
	7177881600
Rated capacity (kg)	9
Maximum spin speed (rpm)	1600
Built-in	No
Height (cm)	84
Width (cm)	60
Depth (cm)	58
Single Water inlet / Double Water inlet	• / -
• Available	
Electrical input (V/Hz)	230 V / 50Hz
Total current (A)	10
Total power (W)	2200
Main model code	1621



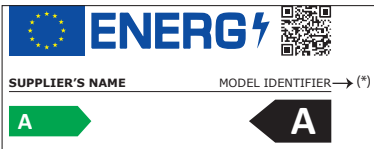









































The model information as stored in the product database can be reached by entering following website and searching for your model identifier (*) found on energy label.

<https://eprel.ec.europa.eu/>



WARNING: Consumption values are applicable for cases where the wireless network connection is off.

Symbols Table

4.1 Installation



Please read the "Safety Instructions" section first!



During the installation, when you turn on the product for the first time, calibration mode* must be run. Calibration mode provides the machine to detect load amount correctly. To activate calibration mode, Drum Clean** program should be selected, and spin speed option should be cancelled. During the cycle, drum must be empty. It takes approximately 15 minutes. In order to complete calibration mode, the program must be run to the end.

*Calibration mode may not be available for all models. In this case, spin speed option is not selectable.

**Program name may change according to the models. You can check the program explanations part to choose correct program.

- Apply to the nearest authorized service agent for the installation of your product.
- Preparation of the location and electrical, tap water and waste water installations at the place of installation is under customer's responsibility.
- Make sure that the water inlet and discharge hoses as well as the power cable are not folded, pinched or crushed while pushing the product into its place after installation or cleaning procedures.
- Make sure that the installation and electrical connections of the product are performed by authorized service agent. Manufacturer shall not be held responsible for damages caused by operations performed by unauthorized persons.
- Prior to installation, visually check if the product has any defects on it. Do not have it installed if the appliance is damaged. Damaged products cause risks for your safety.

4.1.1 Appropriate installation location

- Place the product on a solid and level floor. Do not place it onto a carpet with high pile or other similar surfaces. Inappropriate floor may cause problems of noise and vibration.
- Total weight of the washing machine and the dryer -with full load- when they are placed on top of each other reaches to approx. 180 kilograms. Place the product on a solid and flat floor that has sufficient load carrying capacity!
- Do not place the product on the power cable.
- Do not install the product at places where temperature may fall below 0°C. Freezing might damage your product.
- Leave a minimum space of 1 cm between the product and the furniture.
- If you will install the product on a surface with steps, never place it close to the edge.
- Do not place the product on any platform.
- Do not place heat sources such as Hobs, Irons, Ovens, etc. on the washing machine and do not use them on the product.

4.1.2 Assembly of bottom panel covers

- In order to increase the sound comfort of the product, it is recommended to install the Cover A and Cover B parts after removing styrofoam.

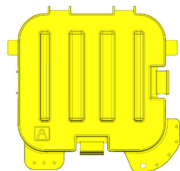

Cover A

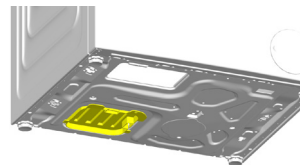
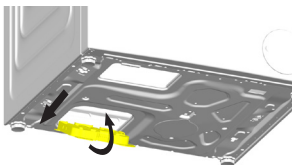

Tilt the machine back slightly. Rest the tabs of Cover A against the lower panel. Complete the assembly by rotating the cover.

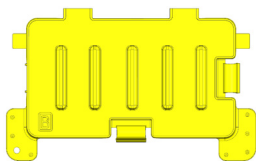

Cover B

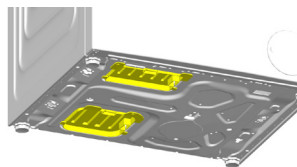
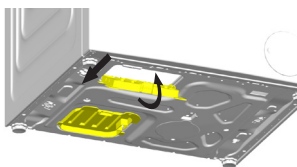

Rest the tabs of Cover B against the lower panel. Complete the assembly by rotating the cover.



Cap

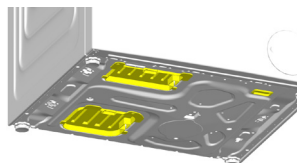
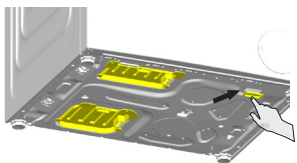

Insert the cap by pushing it with your finger.

4.1.3 Removing transportation safety bolts

- 1 Loosen all transportation safety bolts with an appropriate wrench until they turn freely.
- 2 Stretch the internal component by pressing on the holding areas and pull the component out.
- 3 Attach the plastic covers supplied in the User Manual bag into the holes on the rear panel.

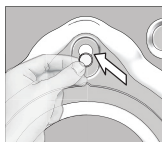
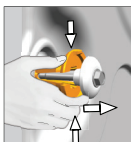
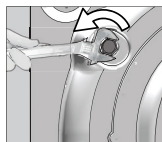

WARNING

Remove the transportation safety bolts before operating the product! Otherwise, the product will get damaged.

Keep the transportation safety bolts in a safe place to reuse when the product needs to be moved again in the future.

Install the transportation safety bolts in reverse order of the disassembly procedure.

Never move the product without the transportation safety bolts properly fixed in place!

4.1.4 Connecting to water supply

WARNING

Models with a single water inlet shall not be connected to the hot water tap. In such a case the laundry will get damaged or the product will switch to protection mode and will not operate.

Do not use old or used water inlet hoses on a new product. It may cause water leakage from your machine and stain your laundry.

- 1 Tighten all hose nuts by hand Never use a tool when tightening the nuts.
- 2 Open the taps completely after making the hose connection to check for water leaks at the connection points. If any leak occurs, turn off the tap and remove the nut. Check the gasket and tighten the nut carefully again. In order to prevent the water leaks and resultant damages, keep the taps closed when you do not use the product.

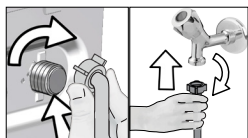

4.1.5 Connecting the drain hose to the drain

- Attach the end of the drain hose directly to waste water drain, washbasin or bathtub.



Your house will be flooded if the drain hose is dislocated during water draining. There is also a risk of burning due to the high washing temperatures! In order to prevent such situations and make sure that the product performs water intake and drain processes without any problem, fix the drain hose securely.

- Connect the drain hose to a minimum height of 40 cm and a maximum height of 100 cm.
- In case the drain hose is elevated after laying it on the floor level or close to the ground (less than 40 cm above the ground), water draining becomes more difficult and the laundry may come out excessively wet. Thus, follow the heights provided in the figure.

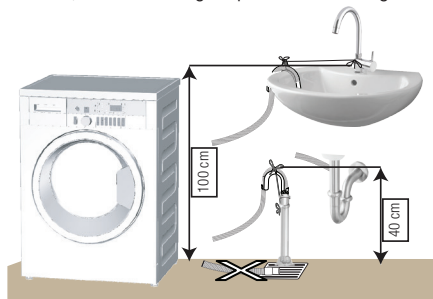

- To prevent the waste water to go back into the product again and to ensure easy drainage, do not immerse the end of the hose into the waste water or do not insert it into the drain for more than 15 cm. If it is too long, cut it short.
- The end of the hose should not be bent, it should not be stepped on and the hose must not be pinched between the drain and the product. Otherwise, water discharge issues may emerge.
- If the length of the hose is too short, use it by adding an original extension hose. The length of the hose shall not be longer than 3.2 m. To prevent water leaks, always secure the connection between the extension hose and the drain hose of the product with a suitable clamp so that it does not come off and cause leaks.

4.1.6 Adjusting the feet

WARNING

In order to ensure that the product operates more silently and vibration-free, it must stand level and balanced on its feet. Ensure that the product is balanced by adjusting the feet. Otherwise, the product may move from its place and cause crushing, noise and vibration problems.

Do not use any tools to loosen the lock nuts. Otherwise, they will get damaged.

- 1 Loosen the lock nuts on the feet by hand.
- 2 Adjust the feet until the product stands level and balanced.
- 3 Tighten all lock nuts again by hand.

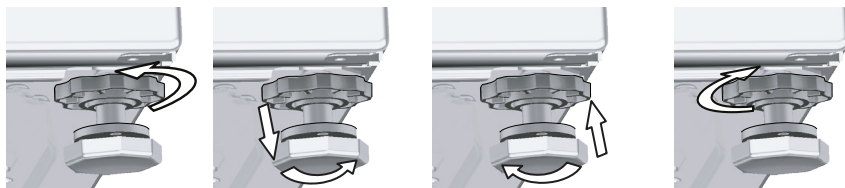

4.1.7 Electrical connection

Connect the product to a grounded outlet protected by a 16 A fuse. Our company shall not be liable for any damages that may arise when the product is used without grounding in accordance with the local regulations.

- Connection must comply with national regulations.
- The electrical connection cable infrastructure of the product must be adequate and suitable for product requirements. It is recommended to use a residual current device.
- Power cable plug must be within easy reach after installation.
- If the current value of the fuse or breaker in the house is less than 16 Amps, have a qualified electrician install a 16 Amp fuse.
- The voltage specified in the "Technical specifications" section must be equal to your mains voltage.
- Do not make connections via extension cables or multi-plugs. Overheating and burning may occur due to the connecting cable.



Damaged power cables should be replaced by the authorized service in order to prevent possible danger.

4.1.8 Initial use



Before starting to use the product make sure that the preparations described in section "Environmental instructions" and "Installation". To prepare the product for washing laundry, perform first operation in Drum Cleaning programme. If this program is not available in your product, apply the method which is described in section "Cleaning the loading door and the drum".



Some water has remained in the product due to the quality control processes in the production. It is not harmful for the product.

4.2 Preliminary preparation



Please read the "Safety Instructions" section first!

4.2.1 How to sort laundry

- Sort laundry according to type of fabric, colour, and degree of soiling and allowable water temperature.
- Always observe the instructions given on the garment care labels.

4.2.2 How to prepare clothes for washing

- Laundry items with metal attachments such as, underwiring, belt buckles or metal buttons will damage the product. Remove the metal pieces or wash such clothes by putting them in a laundry bag or pillow case.
- Take out all substances in the pockets such as coins, pens and paper clips, and turn pockets inside out and brush. Such objects may damage the product or cause noise problem.
- Put small size clothes such as infant's socks and nylon stockings in a laundry bag or pillow case.
- Place curtains in without compressing them. Remove curtain attachment items. Curtain attachment items may cause pulling and tearing on the curtain.
- Fasten zippers, sew loose buttons and mend rips and tears.
- "Wash "Machine washable" or "Hand washable" labelled products only with an appropriate programme.
- Do not wash colours and whites together. New, dark coloured cottons release a lot of dye. Wash them separately.
- Tough stains should be treated properly before washing.
- Wash trousers and delicate laundry turned inside out.
- Laundry that are subjected to materials such as flour, lime dust, milk powder, etc. intensely should be shaken off before placing into the product. Such dusts and powders on the laundry may build up on the inner parts of the product in time and can cause damage.

4.2.3 Tips for energy and water saving

Following information will help you use the product in an ecological and energy/water-efficient manner.

- Operate the product in the highest load capacity allowed for the programme you have selected, but do not overload it. See "Programme and consumption table"
- Observe the temperature instructions on the detergent packaging.
- Wash slightly soiled laundry at low temperatures.
- Use faster programmes for small quantities and lightly soiled laundry.
- Do not use prewash and high temperatures for laundry that is not heavily soiled or stained.
- If you plan to dry your laundry in a dryer, select the highest spin speed recommended during washing process.
- Do not use more detergent than the recommended amount on the detergent packaging.

4.2.4 How to add laundry

- 1 Open the loading door.
- 2 Put the laundry items into the product in a loose manner.
- 3 Push the loading door to close until you hear a interlocking sound. Ensure that no items are caught in the door. The loading door is locked while a programme is running. The door lock will open a few minutes after the washing programme has ended. Then you can open the loading door. If the door does not open, apply the solutions provided for "Loading door cannot be opened" error in the Troubleshooting section.

4.2.5 Correct load capacity

The maximum load capacity depends on the type of laundry, the degree of soiling and the desired washing programme.

The product automatically adjusts the water amount according to the weight of the laundry put inside it.



Follow the instructions in "Programme and consumption table". When the appliances is overloaded product's washing performance will drop. Moreover, noise and vibration problems may occur.

4.2.6 How to use detergent and softener

WARNING

Read the manufacturer instructions on the package while using detergents provided that they are added from the powder detergent compartment number 2, starch, fabric colourants, bleach and decolourants, anti-limescale and follow the dosage information provided. Use the dosing scale, if any.

Do not add additional powder detergent in programs with liquid detergent dosing selected.

Detergent, softener and other cleaning agents

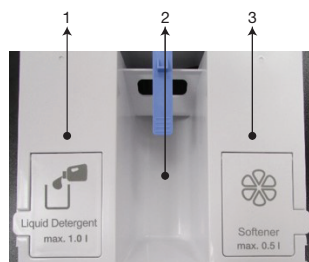

- 1 - Liquid detergent compartment
- 2 - Powder detergent compartment
- 3 - Softener compartment

- Add detergent and softener before starting the washing cycle.
- If you are to use the detergent pod or the dispensing ball, place it directly among the laundry in the product.
- Prewash compartment and prewash option is not available.

WARNING

Gel-like, non-fluid liquid detergents, etc. cannot be used in the detergent compartments or dosing chambers.



Close the detergent compartment before starting the washing program and do not open the detergent compartment while the machine is operating.

Choosing the detergent type

Detergent type to be used depends on the washing programme, fabric type and colour.

- Use separate detergents for coloured and white laundry.
- Wash your delicate clothes only with special detergents (liquid detergent, wool shampoo, etc.) intended solely for delicate clothes and at suggested programmes.
- When washing dark coloured clothes and quilts, it is recommended to use liquid detergent.
- Wash woollens at suggested programme with special detergent made specifically for woollens.
- Please review the programme descriptions part for suggested programme for different textiles.
- All recommendations about detergents are valid for selectable temperature range of programmes.

WARNING

Only detergents, softeners and additives suitable for washing machines should be used. Do not use liquid detergents or other cleaning agents to soften the laundry.

Do not use soap powder.

4.2.6.1 Automatic Dosage

Initial Instalment:

Turn on the machine with On/Off button. Dosage symbol () appears in programs where detergent dosing is allowed. If the liquid detergent or softener compartments are empty, the dosage symbol will flash in programs where detergent dosing is allowed.

Filling Liquid Detergent and Softener



- Open the detergent compartment by pulling it towards yourself.

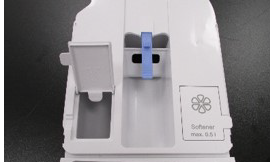

- To fill liquid detergent (left) and softener (right), open the related tank's lid by pulling it upwards as shown in the picture.



- Remember not to exceed the "Max" sign when adding liquid detergent or softener.
- Close the lid of the compartment.
- Close the detergent drawer by pushing lightly.
- After closing the detergent drawer, the flashing dosage symbol (🌀) starts lighting up continuously.
- It indicates that the compartments are filled successfully and the detergent drawer is in its place.

- We recommend filling the detergent compartment with liquid detergents that can be used in common for coloured and white laundry.
- If the detergent symbol is flashing even though the detergent compartments are filled, the detergent drawer is not seated properly. Push the drawer so that it is fully seated.

WARNING	While the detergent drawer is filled with detergent and/or softener: a - Do not pull out the machine b - Do not relocate the machine c - Do not tilt the machine sideways or backwards,
	Before conducting these operations, the detergent drawer must always be removed from the machine.
	If you wish to start the program while there is no detergent in the detergent drawer, liquid detergent dosage must be cancelled and washing with powder detergent is required.
	Only liquid detergent must be put inside the liquid detergent dosing tank and only softener must be put in the softener dosing tank. Putting all kinds of liquid and powder chemicals together inside the tanks may damage your laundry or your machine.

4.2.6.2 Dosage Selection, Cancellation or Use of Powder Detergent

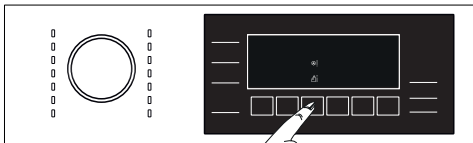

- Liquid detergent cannot be selected in some of the programs. Powder detergent must be used in these cases. For more information, see Programme Table.

- If powder detergent is to be used in programs where the detergent dosing system is operating, desired amount of detergent is put into the powder detergent compartment. If the detergent compartment in the middle is to be used, the automatic dosage selection must be deactivated.
- Machine measures the load and determines the right amount of detergent depending on the load amount and the selections made previously. The detergent taken is not visible while washing, it is taken directly with water over the laundry.
- If another liquid detergent with different properties than the one in the liquid detergent dosing tank is preferred to be used, liquid detergent with said different properties should be put in the powder detergent compartment in the middle and the liquid detergent dosage selection should be deactivated.
- Softener will be taken from the dosing system.

Liquid detergent and softener dosing symbols become active or inactive according to the program selected on the screen.



First position on the display means liquid detergent is active, softener is on. If the liquid detergent and softener symbol is lit, it means that liquid detergent and softener dosing is active.



If the liquid detergent and softener symbols are active on the screen; when you press the Automatic Dosing key for the first time, the liquid detergent will turn on and the softener will turn off. If the softener symbol is not lit, it means that softener will not be used in the rinsing step.



When you press the Automatic Dosing key for the second time, the powder detergent and the softener will turn on. If the liquid detergent symbol is not lit, it means that it can be washed with powder detergent.



When you press the Automatic Dosing key for the third time, the powder detergent will turn on and the softener will turn off. When you press it for the fourth time, it will return to the first position.

4.2.6.3 Detergent and/or Softener Running Out

- When the detergent or the softener put inside the detergent drawer finishes, the dosage symbol in the display flashes. When this symbol flashes, it is necessary to add the decreasing detergent or softener to the dosing tank. The product will be able to dose enough for 2-3 more cycles from the first moment the symbol flashes.

4.2.6.4 Filling Detergent or Softener into the Wrong Compartment:

- In case you fill the detergent or the softener in the wrong compartment, see 4.4.1 “Cleaning the detergent drawer”.

4.2.7 Proper washing recommendations

		Clothes			
		Light Colours and Whites	Colours	Black/Dark Colours	Delicates/Woollens/Silks
		(Recommended temperature range based on soil level: 40-90 oC)	(Recommended temperature range based on soil level: cold-40 oC)	(Recommended temperature range based on soil level: cold-40 oC)	(Recommended temperature range based on soil level: cold-30 oC)
Soiling Level	Heavily Soiled (difficult stains such as grass, coffee, fruits and blood.)	It may be necessary to pre-treat the stains or perform prewash. Powder and liquid detergents recommended for whites can be used at dosages recommended for heavily soiled clothes. It is recommended to use powder detergents to clean clay and soil stains and the stains that are sensitive to bleaches.	Powder and liquid detergents recommended for colours can be used at dosages recommended for heavily soiled clothes. It is recommended to use powder detergents to clean clay and soil stains and the stains that are sensitive to bleaches. Detergents which do not contain decolourant should be used.	Liquid detergents suitable for colours and black/dark colours can be used at doses recommended for heavily soiled clothes.	Prefer liquid detergents produced for delicate clothes. Woollen and silk clothes must be washed with special woollen detergents.
	Normally Soiled (For example, stains caused by body on collars and cuffs)	Powder and liquid detergents recommended for whites can be used at dosages recommended for normally soiled clothes.	Powder and liquid detergents recommended for colours can be used at dosages recommended for normally soiled clothes. Detergents which do not contain decolourant should be used.	Liquid detergents suitable for colours and black/dark colours can be used at doses recommended for moderately soiled clothes.	Prefer liquid detergents produced for delicate clothes. Woollen and silk clothes must be washed with special woollen detergents.
	Lightly Soiled (No visible stains exist.)	Powder and liquid detergents recommended for whites can be used at dosages recommended for lightly soiled laundry.	Powder and liquid detergents recommended for colours can be used at dosages recommended for lightly soiled laundry. Detergents which do not contain decolourant should be used.	Liquid detergents suitable for colours and black/dark colours can be used at doses recommended for lightly soiled laundry.	Prefer liquid detergents produced for delicate clothes. Woollen and silk clothes must be washed with special woollen detergents.



If you wish to use a special liquid detergent, liquid detergent dosing can be cancelled and the special detergent may be put into the powder detergent compartment numbered 2. Delay setting must be completed in these cases.

4.2.8 Displayed Programme Duration

You can view the programme duration on the display of your machine while selecting a programme. Depending on the amount of laundry you have loaded into your machine, foaming, unbalanced load conditions, fluctuations in power supply, water pressure and programme settings, the programme duration is automatically adjusted while the programme is running.

SPECIAL CASE: At start of Cottons and Cotton Eco programmes, the duration for half load is shown on the display. It is the most common use case. After programme starts, in 20-25 minutes actual load is detected by the machine. And if the detected load is higher than half load; washing programme will be adjusted accordingly and programme duration increased automatically. You can follow this change on the display.

4.3 Operating the product



Please read the "Safety Instructions" section first!

4.3.1 Control panel

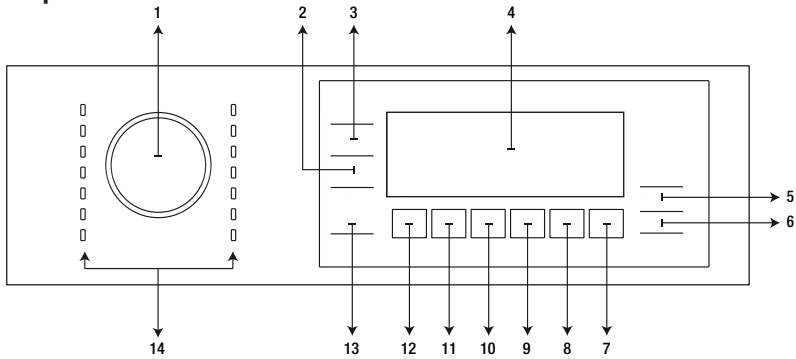

- 1 - Programme selection knob
- 2 - Spin speed adjustment button
- 3 - Temperature adjustment button
- 4 - Display
- 5 - On / Off button
- 6 - Start / Pause button
- 7 - End time adjustment button

- 8 - Auxiliary function button 5
- 9 - Auxiliary function button 4
- 10 - Auxiliary function button 3
- 11 - Auxiliary function button 2
- 12 - Auxiliary function button 1
- 13 - Remote control button
- 14 - Programme selection LEDs

4.3.2 Display symbols

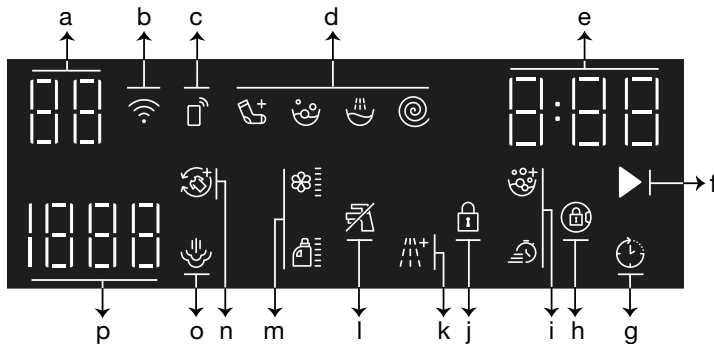

- a- Temperature indicator
- b- Wireless connection indicator
- c- Remote control indicator
- d- Programme tracking indicator
- e- Duration information
- f- Programme start indicator
- g- Delayed start enabled indicator
- h- Door lock engaged indicator

- i - Auxiliary function indicators 5
- j - Child lock enabled indicator
- k - Auxiliary function indicators 4
- l - No water indicator
- m - Auxiliary function (dosing) indicators 3
- n - Auxiliary function indicator 1
- o - Auxiliary function indicator 2
- p - Spin speed indicator



Images used in this section to describe the product are schematic and may not be exactly the same as the actual product.

4.3.3 Programme and consumption table

EN	Programme	Max. Load (kg)	Water Consumption (l)	Energy Consumption (kWh)	Max. Speed	Auxiliary functions					Selectable temperature range °C
						Steam	Express / Intensive	Extra Rinse	ProDose	Anti-Crease+	
Cottons	90	9	98	2,75	1600	•	•	•	•	•	Cold - 90
	60	9	98	2,00	1600	•	•	•	•	•	Cold - 90
	40	9	95	1,10	1600	•	•	•	•	•	Cold - 90
Eco 40-60	40 ***	9	55	0,690	1600				•		40-60
	40 ***	4,5	40	0,490	1600				•		40-60
	40 ***	2,5	34	0,320	1600				•		40-60
Synthetics	60	4	76	1,60	1200	•	•	•	•	•	Cold - 60
	40	4	74	1,10	1200	•	•	•	•	•	Cold - 60
Mini / Mini 14'	90	9	75	2,30	1200	•	•	•	•	•	Cold - 90
	60	9	75	1,30	1200	•	•	•	•	•	Cold - 90
	30	9	75	0,25	1200	•	•	•	•	•	Cold - 90
Mini / Mini 14' + Express	30	2	45	0,15	1200	•	•	•	•	•	Cold - 90
WoolProtect / Hand Wash	40	2	60	0,60	1200			•	•		Cold - 40
Outdoor / Sport	40	4	60	0,65	1200				•		Cold - 40
MachineCare	90	-	80	2,60	600	*					90
Supreme Refresh	-	1	1,1	0,11	-	*					-
SenseWash	60	9	****	****	1600		•	•	•	•	Cold - 60
HygieneCare+	90	9	125	3,00	1600	*		*	•		20-90
Shirts	60	4	70	1,40	800	*	•	•	•	•	Cold - 60
Downloaded Program*****											
Mix	40	4	83	1,10	800	•	•		•	•	Cold - 40
Lingerie	30	1	78	0,30	600			*	•		Cold - 30
Delicates	40	4	65	0,85	800			•	•		Cold - 40
Curtain	40	2	98	0,90	800			*	•		Cold - 40
Cool Clean	-	4,5	64	0,35	1200				•	•	Cold - 30
Soft Toys	40	2	80	0,90	600			*	•		Cold - 40

• : Selectable.

* : Automatically selected, cannot be cancelled.

*** : 40 °C temperature selection in the Eco 40-60 programme is a test programme as per EU/2019/2014 EU directive EN 60456:2016/A11:2020 and standard.

***** : These programmes can be used with the HomeWhiz application. Energy consumption may increase due to connection.

- : See the programme description for maximum load.



Please check installation section of user manual before the first use of your product

The auxiliary functions in the table may vary according to the model of your machine.

Water and energy consumption may vary subject to the changes in water pressure, water hardness and temperature, ambient temperature, type and amount of laundry, selection of auxiliary functions and spin speed, and changes in electric voltage.

You can see the washing duration on the display of your machine while selecting a programme. Depending on the amount of laundry you have loaded into your machine, there may be a difference of 1-1.5 hours between the duration shown on the display and the actual duration of the wash cycle. Duration will be automatically updated soon after the washing starts.

Selection patterns for auxiliary functions can be changed by the manufacturer company. New selection patterns can be added or removed.

The spin speed of your machine may vary according to the programme; this spin speed cannot exceed the max. spin speed of your machine.

Always select the lowest appropriate temperature. The most efficient programmes in terms of energy consumption are generally those that wash at low temperatures for a long time.

Noise and humidity level varies as per the spin speed; when you select a higher speed at the spinning stage, you will have laundry with less humidity at the end of the programme, but a higher noise will occur.

Consumption Values (EN)

	Temperature Selection (°C)	Spin Speed (rpm)	Capacity (kg)	Programme Duration (hh:mm)	Energy Consumption (kWh/cycle)	Water Consumption (L/cycle)	Laundry Temperature (°C)	Remaining Moisture Content (%)
Eco 40-60	40	1600	9	03:48	0,690	55	33	44,9
	40	1600	4,5	02:53	0,490	40	28	44,9
	40	1600	2,5	02:53	0,320	34	22	44,9
Cottons	20	1600	9	03:40	0,750	95	20	44,9
	60	1600	9	03:40	2,000	98	60	44,9
Synthetics	40	1200	4	02:20	1,100	74	40	40
Mini / Mini 14'	30	1200	9	00:28	0,250	75	23	62

The values given for programmes other than the eco 40-60 programme are indicative only.

4.3.4 Programme selection

- 1 In accordance with the "Programme and consumption table", select a suitable programme for the amount and soiling level of the laundry.



Programmes are limited to the highest spin speed appropriate for that particular type of fabric.

When selecting a programme, always consider the type of fabric, colour, soiling level and permissible water temperature.

- 2 Use the Programme Selection knob to select the desired programme.

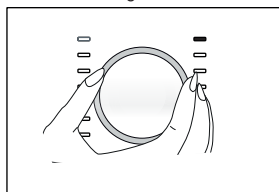

4.3.5 Programmes

• Eco 40-60

In the Eco 40-60 programme, you may wash normally soiled cotton laundry that are specified to be washed together at 40°C or 60°C. This programme is the standard test programme according to the EU environmentally friendly design and energy labelling regulations.

Although this programme washes longer than other washing programmes, it is more efficient in terms of energy and water consumption. Actual water temperature may be different from the stated wash temperature. When you load the machine with less laundry (e.g. ½ capacity or less), periods in programme stages may automatically get shorter. In this way, energy and water consumption would be much less.

• Cottons

You can wash your durable cotton laundry (sheets, bedlinen, towels, bathrobes, underwear etc.) in this programme. When the quick wash function button is pressed, programme duration becomes notably shorter but effective washing performance is ensured with intense washing movements. If the quick wash function is not selected, effective washing and rinsing performance is ensured for your heavily soiled laundry.

• Synthetics

You can wash your laundry (such as shirts, blouses, synthetic/cotton blended fabrics etc.) in this programme. When the quick wash function button is pressed, programme duration becomes notably shorter and effective washing performance is ensured for your lightly soiled laundry. If the quick wash function is not selected, effective washing and rinsing performance is ensured for your heavily soiled laundry.

• WoolProtect / Hand Wash

Use to wash your woollen/delicate laundry. Select the appropriate temperature complying with the tag of your clothes. Your laundry will be washed with a very gentle washing action in order not to damage the clothes.

• HygieneCare+

Applying a steam step at the beginning of the programme allows to soften the dirt easily.

Use this programme for your laundry (baby clothes, bed sheets, bedlinen, underwear, etc. cotton items) that requires an anti-allergic and hygienic washing at high temperature with intensive and long washing cycle. The high level of hygiene is ensured thanks to the steam application before the programme, long heating duration and additional rinsing step.

• Programme was tested by "The British Allergy Foundation" (Allergy UK) with the 60°C temperature option selected and it was certified in terms of its efficacy in eliminating allergens in addition to bacteria and mould.



Allergy UK is the brand of the British Allergy Association. Seal of Approval is created to guide people that require recommendation about a product that the related product restricts / reduces / eliminates the allergens or reduces the allergen content significantly in the ambient where allergy patients exist. It aims to provide assurance that the products are tested scientifically or examined in a way to provide measurable results.

• Spin+Pump

You can use this program to remove the water on the garment/inside the machine.

• Rinsing

Use when you want to rinse or starch separately.

• Supreme Refresh

Use this programme to reduce the creases and ironing times of a small amount of unspotted cotton, synthetic or mixed laundry.

• **Curtain**

You can use this programme to wash your tulles and curtains. As their meshed texture causes excessive foaming, put little amount of detergent into the main washing compartment. Thanks to the special spin profile of the programme, tulles and curtains crease less. Do not load your curtains above the specified capacity in order not to damage them.



It is recommended to use special detergents produced for curtains in the powder detergent compartment in this programme.

• **Shirts**

This programme is used to wash the shirts made from cotton, synthetic and synthetic blended fabrics altogether. It reduces wrinkles. Steam is applied at the end of the programme to help the wrinkle reducing function. The special spin profile and steam applied at the end of the programme reduce the wrinkles on your shirts. When the quick wash function is selected, the Pre-treatment algorithm is executed.

- Apply the pre-treatment chemical on your garments directly or add it together with the detergent in the powder detergent compartment. Thus, you can obtain the same performance as you obtain with normal washing in a much shorter period of time. Usage life of your shirts increases. Do not use pre-wash detergent if you are planning to use delay function of your machine. Pre-wash detergent may pour out on your clothes and cause stains.

**It is recommended to operate the cycle with no more than 6 shirts to get the best wrinkle level in your shirts using this cycle. When washing is operated with more than 6 shirts, there may be differences on the wrinkle levels and humidity on shirts at the end of cycle.

• **Mini / Mini 14'**

Use this programme to wash your lightly soiled or unspotted cotton clothes in a short time but not for towels or heavy cottons. The programme duration can be reduced down to 14 minutes when the quick wash function is selected. When the quick wash function is selected, maximum 2 (two) kg of laundry must be washed.

• **MachineCare**

Regularly clean (once every 1 to 2 months) the drum for ensuring the required hygiene. Steam is applied before the programme to soften the residues in the drum. Turn on the programme when the machine is completely empty. For more effective results, place powder anti-limescale (drum cleaning materials) suitable for washing machines inside the detergent compartment no. "2". Leave the loading door half closed after the programme ends for the inside of the machine to dry.



This is not a washing programme. This is a maintenance programme.

Do not turn this programme on when there is something inside the machine. When you attempt to operate, the machine automatically senses that there is load inside, and may quit or resume the programme as per the model of your machine. An effective cleaning is not achieved if the programme is resumed.

• **Mix**

Use to wash your cotton and synthetic clothes together without sorting them.

• **SenseWash**

Use to wash frequently washable cotton, synthetic or blended (cotton+synthetic) clothes. Programme detects the type and quantity of the laundry to automatically adjust water consumption and programme time.



WARNING: Do not wash your woollen and delicate clothes in this programme.

Select a suitable temperature if the temperature shown on the temperature display is not compatible with the warnings on the garment label.

The maximum washing temperature in Automatic programme depending on the soiling level and laundry type is 60°C. Washing performance may not be at the desired level for heavily soiled whites and stubborn stains (collar, sock soil, perspiration stain, etc.). In this case, it is recommended to select Cottons programme with prewash and set the temperature to 50-60°C.

Many types of clothing are correctly detected and safely washed in Automatic programme.

• Delicates

You can wash your delicate clothes such as cotton/synthetic blended knitwear or hosiery in this programme. It washes with more delicate washing action. Wash your clothes whose colour you want to preserve either at 20 degrees or by selecting the cold wash option.

• Lingerie

You can use this programme to wash delicate garments that are suitable for hand wash and delicate women's underwear. Small amount of garments must be washed in a washing net. Hooks, buttons etc. must be done up and zips must be zipped up.

• Cool Clean

Use to wash your moderately soiled and durable cotton/synthetic laundry. An effective washing is provided thanks to the intense washing action and double jet system.

• Outdoor / Sport

You can use this programme to wash sports and outdoors garments that contain cotton/synthetics mix and water repellent covers such as gore-tex etc. It makes sure your garments are washed gently thanks to special rotating movements.

• Downloaded Program

This is a special programme that allows you to download different programmes when you want to. At the start, there is a programme you can see with the HomeWhiz application as default. However, you can use the HomeWhiz application to select a programme from the predetermined programme set, and then change and use it.



Select Programme Download feature if you want to use HomeWhiz feature and Remote Control function. 4.3.15 Please refer to HomeWhiz Feature and Remote Control Function for more details.

• Soft Toys

Soft toys must be washed in a delicate programme due to their delicate fabrics, and the fibre and accessories they contain. Thanks to its delicate washing movements and spinning profile, the soft toys programme protects the toys during washing. It is recommended to use liquid detergent.



Fragile toys with hard surfaces must not be washed under any circumstances.

Toys must not be washed together with your garments since they may harm laundry.

4.3.6 Temperature selection

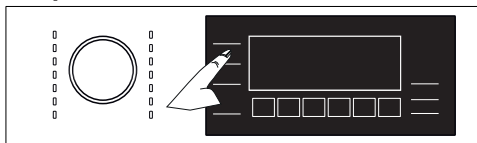

Whenever a new programme is selected, the recommended temperature for the programme appears on the temperature indicator. It is possible that the recommended temperature value is not the maximum temperature that can be selected for the current programme.

Press the Temperature Adjustment button to change the temperature. Temperature decreases gradually.



No change can be made in programmes where temperature adjustment is not allowed.

You can also change the temperature after the washing starts. This change can be made if the only washing steps allow it.



If you scroll to cold wash option and press Temperature Adjustment button again, the recommended maximum temperature for the selected programme appears on the display. Press the Temperature Adjustment button again to decrease the temperature.

4.3.7 Spin speed selection

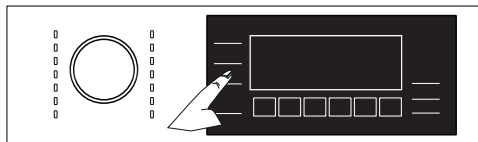

Whenever a new programme is selected, the recommended spin speed of the selected programme is displayed on the Spin Speed indicator. It is possible that the recommended spin speed value is not the maximum spin speed that can be selected for the current programme.

Press the Spin Speed Adjustment button to change the spin speed. Spin speed decreases gradually. Then, depending on the model of the product, "Rinse Hold I_J" and "No Spin —" options appear on the display. If you are not going to unload your laundry immediately after the programme completes, you can use Rinse Hold function in order to prevent them from getting wrinkled when there is no water in the machine. This function holds the laundry in the final rinsing water.

If you want to spin your laundry after the Rinse Hold function:

- Adjust the Spin Speed.
- Press Start/Pause. The programme will resume. Machine drains the water and spins the laundry. If you want to drain the water at the end of the programme without spinning, use No Spin function.



No change can be made in programmes where spin speed adjustment is not allowed.

You can change the spin speed after the washing starts if the washing steps allow it. Changes cannot be made if the steps do not allow it.

Rinse Hold

If you are not going to unload your clothes immediately after the programme completes, you can use rinse hold function to keep your laundry in the final rinsing water in order to prevent them from getting wrinkled when there is no water in the machine. Press Start/Pause button after this process if you want to drain the water without spinning your laundry. Programme will resume and complete after draining the water.

If you want to spin the laundry held in water, adjust the Spin Speed and press Start/Pause button.

The programme will resume. Water is drained, laundry is spun and the programme is completed.

4.3.8 Auxiliary function selection

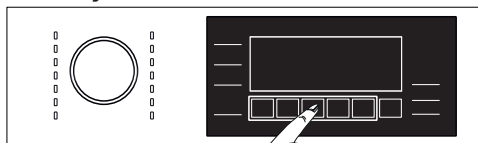

Select the desired auxiliary functions before starting the programme. Whenever a programme is selected, icons of the auxiliary function symbol that is selected together with it illuminates.



If you select an auxiliary function that cannot be selected with the current programme, the washing machine makes a warning noise.

Also, the frames of the auxiliary function selected for the current programme after the washing has started remains lit.



Some functions cannot be selected together. If a second auxiliary function conflicting with the first one is selected before starting the machine, the function selected first will be cancelled and the second auxiliary function selection will remain active. For example, if you want to select Quick Wash after you have selected the Additional Water, Additional Water will be cancelled and Quick Wash will remain active.

An auxiliary function that is not compatible with the programme cannot be selected. (See "Programme and consumption table")

Some programmes have auxiliary functions that must be operated simultaneously. Those functions cannot be cancelled. The frame of the auxiliary function will not be illuminated, only inner area will be illuminated.

4.3.8.1 Auxiliary functions

• Express / Intensive

You can shorten or extend the programme duration with this function. Depending on the programme selection, there may be differences in time increases and decreases. In case the QUICK or INTENSIVE LED is not lit, the appropriate programme duration is shown for your normally soiled laundry.

Depending on the programme selection, the Intensive feature can be selected automatically. In this case, the Intensive LED on the panel will be on. You can use the Intensive selection to achieve a better washing performance when washing heavily soiled laundry.

You can reduce the time for your lightly soiled laundry by pressing the Quick/Intensive button for the programmes of intense are selected. When you press the button once, the LED will turn off and you will reach the appropriate programme duration for your normally soiled laundry. When you press the same button a second time, the fast LED will light up, the time will decrease a little and it will show the minimum programme duration, which is suitable for your less soiled laundry. The duration of programmes may be shortened by 50% when this function is selected. Thanks to the optimized washing steps, high mechanical operation capability and optimum water consumption, a higher washing performance is achieved although the duration is shorter.

• Extra Rinse

This function enables the product to make additional rinsing in addition to the one already made after the main wash. Thus, the risk for sensitive skins (babies, allergic skins, etc.) to be effected by the minimal detergent remnants on the laundry can be reduced.

• Steam

This function helps to reduce the creases of your cotton, synthetic and mixed clothes, shorten the ironing time and remove the dirt by softening.

*Your laundry may be hotter at the end of the washing cycle when the steam function is applied at the end of the programme. This is an expected condition within the operating conditions of the programme.



Do not use liquid detergents if no liquid container or liquid detergent dosing feature is available. There is the risk of staining of the clothes.

• ProDose

You can change your dosage and detergent preferences with this auxiliary function key. For detailed information, see "4.2.6.2 Dosage Selection, Cancellation or Use of Powder Detergent".

• Remote Control

You can use this auxiliary function key to connect your product to smart devices. For detailed information, see 4.3.15 HomeWhiz Function Feature and Remote Control Function.

• Customized Programme

This auxiliary function can only be used for Cotton and Synthetics programmes together with the HomeWhiz application. When this auxiliary function is activated, you can add up to 4 auxiliary rinsing steps to the programme. You can select and use some auxiliary functions even though they are not found on your product. You can increase and decrease the time of the Cottons and Synthetics programmes within a safe range.



When the Programme Personalisation auxiliary function is selected, the washing performance and energy consumption will be different than the declared value.

4.3.8.2 Functions/Programmes Selected by Pressing the Function Keys for 3 Seconds

- **Anti-Crease+** 

Press and hold 1. Auxiliary function button for 3 seconds. When the function is selected, the drum rotates for up to 8 hours for preventing the laundry from creasing at the end of the programme. You can cancel the programme and take your laundry out at any time during the 8-hour duration. Press the function selection key or the machine on/off key to cancel the function.

- **Auto Dosage Setting** 

Activates by pressing down the 3rd auxiliary function key (automatic dosage) for 3 seconds. Liquid Detergent or Softener dosage amount can be changed with this function.

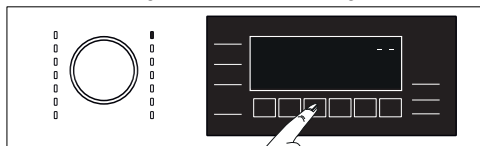

Changing liquid detergent and softener dosage settings:

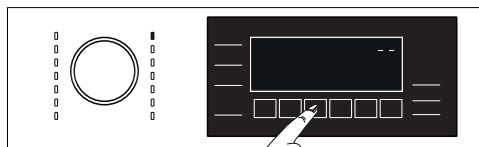

- Press and hold Automatic Dosage key for 3 seconds.

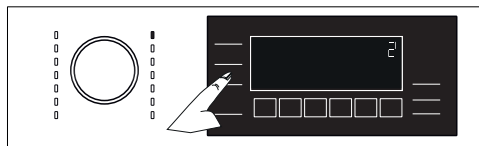

- The liquid detergent dosage level settings can be changed by pressing down “Spin” selection key as shown below:
1 : Low
2 : Medium
3 : High

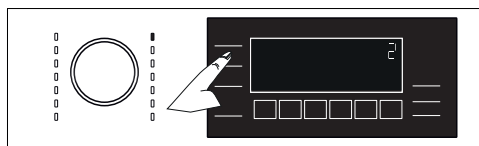

- The softener dosage level settings can be changed by pressing down “Temperature” selection key as shown below:
1 : Low
2 : Medium
3 : High
- When dosage amount setting process is completed, you can return to the main menu by pressing the automatic dosage key. Until a new setting is selected, dosing will be done according to the latest setting you have selected in all programs.

• Child lock

Use Child Lock function to prevent children from tampering with the machine. Thus you can avoid any changes in a running programme.



You can switch on and off the machine with On / Off button when the Child Lock is active. When you switch on the machine again, programme will resume from where it has stopped.

When the Child Lock is enabled, an audio warning will be given if the buttons are pressed. Audio warning will be cancelled if the buttons are pressed five times consecutively.

To activate the Child Lock:

Press and hold 5th Auxiliary function button for 3 seconds. After the countdown as "3- 2- 1" on the display is over, child lock symbol appears on the display. You may release the 5th Auxiliary function button when this symbol is displayed.

To deactivate the Child Lock:

Press and hold 5th Auxiliary function button for 3 seconds. After the countdown as "3- 2- 1" on the display is over, child lock symbol disappears.

• Wireless Connection

You can match your machine and your smart devices with the wireless connection. This way, you can use your smart device to get information about your machine and control it.

To activate wireless connection:

Press and hold Remote Control function button for 3 seconds. After countdown "3- 2- 1" on the screen ends, "On" symbol appears. When this notification is displayed stop pressing **the button on the remote control**. The wireless connection icon blinks when the product is connecting the internet. If connection is successful, icon will remain on.

To deactivate wireless connection:

Press and hold Remote Control function button for 3 seconds. Countdown "3- 2- 1" will be displayed, and then "Off" icon will appear on the display.



To be able to enable wireless connection, machine setup should be completed through HomeWhiz application. After setup, wireless connection will be enabled if you press on "Remote Control" button.

4.3.9 End Time

Time display

When the end time function is selected, the remaining time until the programme starts is shown in hours such as 1h, 2h, and the remaining time to complete the programme after your programme starts is shown in hours and minutes as in the 01:30 example.



Programme duration may differ from the values in section "Programme and consumption table" depending on the water pressure, water hardness and temperature, ambient temperature, amount and the type of laundry, auxiliary functions selected and the changes at the mains voltage.

After a certain period of time after the end time function is activated, the machine goes into standby mode and some LEDs on the screen turn off. If there is any user input, the LEDs will turn on again.

With the **End Time** function, the start-up of the programme may be delayed up to 24 hours. After pressing **End Time** button, the programme's estimated ending time is displayed. If the **End Time** is set, **End Time** indicator is illuminated.

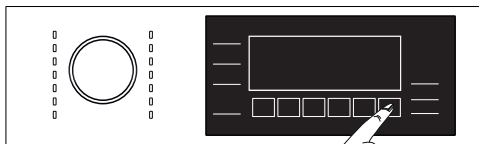

In order for the End Time function is activated and the programme is completed at the end of the specified time, you must press **Start/Pause** button after adjusting the time.

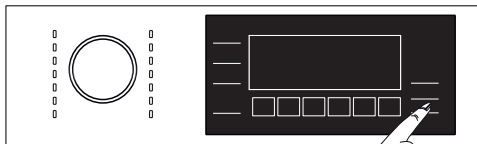

If you want to cancel the End Time function, turn off and on the product by pressing the **On/Off** button.

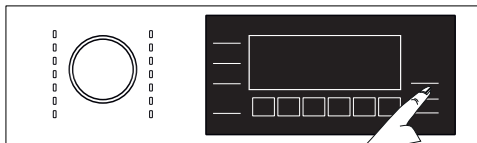

When you have activated the End Time function, do not add liquid detergent in the powder detergent compartment no. 2. There is the risk of staining of the clothes.

- 1 Open the loading door, place the laundry and put detergent, etc.
- 2 Select the washing programme, temperature, spin speed and, if required, the auxiliary functions.
- 3 Set the end time of your choice by pressing the **End Time Setting** button. **End Time Setting** indicator illuminates.
- 4 Press **Start/Pause** button. Time countdown starts.



Additional laundry can be added into the machine during the End Time countdown. At the end of the countdown, End Time indicator turns off, washing cycle starts and the time of the selected programme appears on the display.

4.3.10 Starting the Programme

- 1 Press Start/Pause button to start the programme.

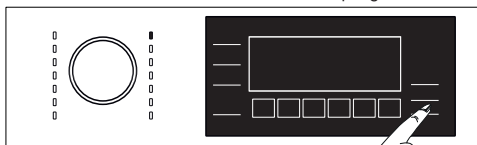

- 3 Loading door is locked. The door lock symbol appears on the display after the loading door is locked.
- 4 Programme follow-up indicator lights on the display will show the current programme step.



If no programme is started or no button is pressed within 10 minutes during programme selection process, the product will automatically turn off. Display and all indicators turn off. If you press On/Off button, the default selected programme information is displayed.

4.3.11 Loading door lock

There is a locking system on the loading door of the machine that prevents opening of the loading door in cases when the water level is unsuitable.

The “Door locked” symbol appears on the display when the loading door is locked.



If the Remote Control Function is selected, the door will be locked. In order to open the door you must deactivate Remote Control Function by either pressing the Remote Control button or changing the programme position.

Opening the loading door in case of power failure:



In case of power failure, you can use the loading door emergency handle under the pump filter cap to open the loading door manually.



To avoid any water overflow before opening the loading door, make sure there is no water left inside the machine.

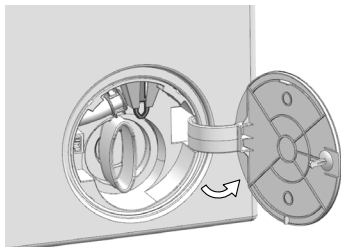

- Turn off and unplug the device.
- Open the pump filter lid.

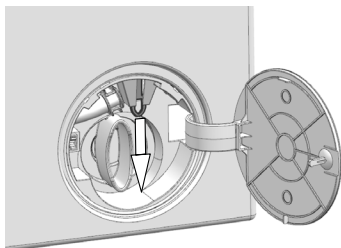

- Pull the loading door emergency handle with a tool and release it. Then, open the loading door.
- Repeat the previous step if the loading door does not open.

4.3.12 Changing the selections after programme has started

Adding laundry after the programme has started

When you push on the **Start/Pause** button, laundry add symbol on the display will illuminate, door lock will be disabled if the machine is available for laundry. The door lock icon on the display goes off when the door lock is deactivated. After adding laundry, close the door and press Start/Pause button once again to resume the washing cycle.

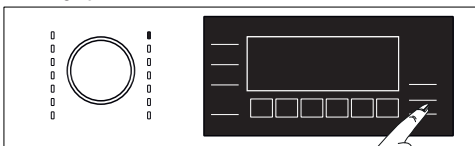

If the water level in the machine is not suitable when you press **Start/Pause** button, the door lock cannot be deactivated and the door lock symbol on the display remains on.



If the temperature of the water inside the machine is above 50°C, you cannot deactivate the door lock for safety reasons, even if the water level is suitable.

Switching the machine to pause mode:

You can switch the machine to pause mode if the **Start/Pause** button is pressed when any programme is operating. Pause symbol will flash on the display.

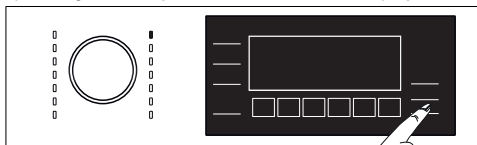

Changing the programme selection after programme has started:

Programme cannot be changed when a programme is running. You need to pause the operating programme if the Child Lock is not active and select a new programme. This action will cancel the current programme.



The selected programme starts anew.

Changing the auxiliary function, speed and temperature

Depending on the step the programme has reached, you can cancel or activate the auxiliary functions. See "Auxiliary function selection".

You can also change the speed and temperature settings. See "Spin speed selection" and "Temperature selection".



It gives out an audio warning if change is not allowed.

The loading door will not open if the water temperature in the machine is high or the water level is above the loading door baseline.

4.3.13 Cancelling the programme

When the machine is turned on and the programme gets cancelled. Press and hold **On/Off** button for 3 seconds.

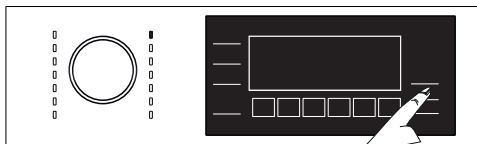

If you press the On/Off button when the Child Lock is enabled, the programme will not be cancelled. You should cancel the Child Lock first.

If you want to open the loading door after you have cancelled the programme but it is not possible to open the loading door since the water level in the machine is above the loading door baseline, then turn the Programme Selection knob to Pump + Spin programme and drain the water in the machine.

4.3.14 End of programme

"End" symbol appears on the display when the programme is completed.

The product automatically shuts down if no buttons are pressed for 10 minutes. Display and all indicators are turned off.

Completed programme steps will be displayed if you press the On/Off button.

4.3.15 Remote Control Function

You can check your washing machine from smart devices and get information about the status of your machine thanks to the Remote Control function. You can carry out many operations on your machine from your smart device by using the Remote Control application. Moreover, you can use certain properties only with the Remote Control Function.

You need to download Remote Control app from the related application market to your smart device in order to use the wireless connection function in your machine.

To use the app, make sure your smart device is connected to the internet.

If you are using the app for the first time, complete user account registration by following the directions on the app. You can use all HomeWhiz featured products in your home through this account after registration is complete.

The Bluetooth of your smart device should be on and your device should be connected to the internet during setup. Your smart device should be close to the washing machine. After the setup, the Bluetooth can be turned off or your smart device does not need to be close to the washing machine. You may use your product provided that your smart device is connected to internet.

You may see the products paired with your account by touching the “Add/Remove Product” button on the “Products” page in the app. You may perform the user pairing operation of these products on this page. After the app is setup, with the Remote Control Function, your washing machine can give you instant status notifications via your smart device.



Please visit www.homewhiz.com link to learn which Android and IOS versions are supported by HomeWhiz application.

Your washing machine will send you notifications over HomeWhiz application in the following cases:

- At the end of the programme,
- When the door of the washing machine is opened,
- In case of water cut warning,
- In case of security warning,



In order to use the Remote Control function, the application should be set up on your smart device and your washing machine should be connected to your home network. When your washing machine is not connected to the network, it operates like a machine without HomeWhiz function.

Your product shall run with a connection to the wireless network in your home network. The controls made on the application shall be provided over this network, so the wireless signal strength where the machine is located should be adequate.

Operates at HomeWhiz 2.4 GHz frequency band.



All safety measures described in the “**GENERAL SAFETY INSTRUCTIONS**” titled section of the user manual are also valid for remote operation with Remote Control function.

Internet connection is required in order to use the Remote Control function. Otherwise, your app will not run on your smart device. Contact your internet service provider if you have issues with your internet connection.

4.3.15.1 Remote Control Set Up

A connection should be set between your product and the app in order for the app to function.



Internet connection is required in order to use the Remote Control function. Otherwise, your app will not run on your smart device. Contact your internet service provider if you have issues with your internet connection.

- If you are adding a product for the first time, touch “Add/Delete Product” section on your app and touch “Touch here to connect the product to the network”. Follow the steps in the app for the set up.
- To start the setup, make sure that your machine is turned off. Press **On/Off** switch and **Remote Control** button simultaneously for 3 seconds to turn your washing machine into Remote Control setup mode.

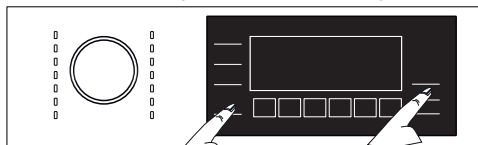

- An animation appears in the setup of the Remote Control and the wireless connection icon will blink until your machinery connects to the internet. Only the On/Off button will be active in this mode. Other buttons will not work.

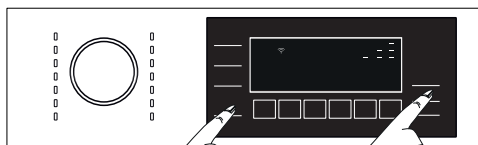

- Press “Add/Delete Product” button on the screen in the app and click on “Connect new product to the network” opening on the screen.

- Follow the instructions on the remote control application screen.
- When setup is complete, give your washing machine a name. On the "Products" page in the app you can see the product you just added.



If you cannot complete the setup successfully in 5 minutes, your washing machine will automatically turn itself off. In this case, you will have to start over the setup steps. If the problem is persisting, contact authorized service.

You can use your washing machine with more than one smart device. To do this, download the Remote Control app on the other smart devices as well. When you launch the app, you will need to log in with the account you previously created and paired your washing machine. Otherwise, please read "Setting up a washing machine that is connected to someone else's account".



Remote Control Application may require you to type the product number shown on the product label. You can find the product label inside of the loading door. The product number will be shown on this label.



4.3.15.2 Setting up a washing machine that is connected to someone else's account

If the washing machine you want to use, has been registered to the system with someone else's account, first create a new account for the Remote Control registration and setup and open the HomeWhiz app with this account. Follow the steps detailed in section 4.3.15.1 after login and set up the appliance.



Your product adding request shall be sent to the owner of the product by e-mail. You may start to use the product in common after the owner confirms. In addition, the owner of the product may accept or reject the request sent by the app. Click on the settings tab on the home page of the application. Enter the User Matching Settings and the sent request is accepted if desired.

4.3.15.3 Deleting the Remote Control Account Match

Follow the following steps in order to delete a washing machine previously matched with someone else's account.

- Turn on your machine by using the On/Off button.
- When your machine is running, push and hold the **Remote Control** and **End Time Setting** buttons for 5 seconds.

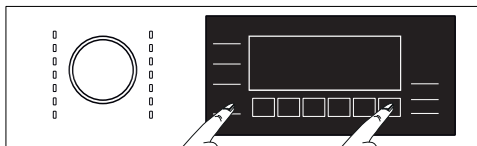

- You will hear a beep to notify your request after the countdown "5- 4- 3- 2- 1" on the screen. Deleting the match will take a few seconds.



After this operation, you cannot use the Remote Control function of your washing machine until you do another setup.

Your product does not need to be connected to the internet in order to delete an account matching. Your request will be received. This matching will be automatically deleted when the product is first connected to the internet.

4.3.15.4 Remote Control function and its use

The wireless connection will automatically turn on after the Remote Control setup. To activate or deactivate the wireless connection, see "4.3.8.2 Wireless Connection".

If you turn your washing machine off and on when the wireless connection is active, the wireless connection will re-connect. In cases of changing your network password or turning the modem off, the wireless connection will automatically turn off. Therefore, you will need to re-open the wireless connection when you want to use the Remote Control function.

You can check your connection status with the wireless connection symbol on the screen. If the symbol is continuously on, it means you have internet connection. If the symbol is blinking, it means the machine is trying to connect. If the symbol is off, you have no connection.



When the wireless connection is on in your product, Remote Control function will be selectable.

If the Remote Control function cannot be selected, check the connection status. If the connection cannot be established, repeat the initial setup settings on the appliance.

If you want to control your washing machine remotely, press **Remote Control** button on the control panel and activate the Remote Control function. Once access is established to the product, you will see a screen similar to the one below.

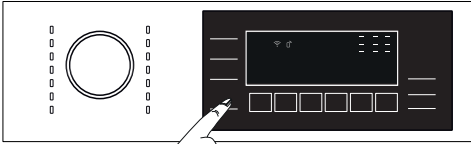

When the Remote Control Function is on, only the machine can be turned on and off and status can be tracked. And all functions except child lock can be managed through the application.

You can follow whether the Remote Control function is on or off through the function indicator on the display. If the Remote Control function is Off, all the operations are handled on the washing machine and only status follow-up is allowed on the application.

Remote Control function may not be activated if the remote connection is off or the product door is on.

When you activate this machine once on the washing machine, certain conditions will remain in the external cycle and will operate whether or not your machine is on or off and will give you the chance to check your machine over the internet wherever you are.

In certain cases, it deactivates itself for safety reasons:

- When your washing machine undergoes a power interruption
- When the door of the washing machine is opened,
- When on/off button is pressed on the control panel

4.3.15.5 Troubleshooting

Do the following if you have a problem with controlling or connection. Observe whether the problem continues after the procedure you have carried out or not. If the problem continues, perform the following steps.

- Check whether your smart appliance is connected to the relevant home network.
- Close and reopen the product app.
- Enter settings on the menu and adjust the Wireless Connection: Off status to Wireless Connection: and re-connect via the application.
- If the connection cannot be established with the above steps, repeat the initial setup settings on the washing machine.

Contact authorised service if the problem cannot be corrected.

4.4 Maintenance and cleaning



Please read the "Safety Instructions" section first!

Service life of product extends and frequently experienced problems will be reduced if it is cleaned at regular intervals.

4.4.1 Cleaning the detergent drawer

When to clean

- If you see hardened, viscous detergent or softener when you open the dosing container lid,
- If you are not satisfied with the washing results (the detergent or softener may not be taken into the washing medium since it is hardened),
- If the liquids in the compartment do not decrease for a long time even though you do not add detergent or softener and dosing is selected,
- If you want to change the washing agents you have added to the compartment (for example, if you are not satisfied with the detergent and do not want to use it) or if you have made a mistake when adding the agents (for example, if you have added detergent to the softener compartment or softener to the detergent compartment),
- If you are going to add a detergent or softener from a different brand than the one you normally use,
- If you are adding a washing agent of a different nature (for example, if you are adding detergent for coloured laundry when there is detergent for white laundry in the compartment),
- If you are adding a washing agent with a different concentration (To not waste the old detergent, you can add it to the powder detergent compartment in the next wash and select «powder detergent active» on the display.)
- If the new softener to be added has the same characteristics but has a different scent (please keep in mind that if you add the new softener without cleaning the remnants of the previous one, this mixture will give a different smell),
- If you are not going to use the product for a long time (for example, when going to the summer house and when returning - 3 months or more) (the washing agent may increasingly thicken and get hardened in the end, and thus the system may not perform dosing even if it shows that the compartments are full.)

Cleaning:

Before cleaning, press the On/Off button to switch of the product and unplug it.



It is recommended for you to wear a glove to avoid contacting the detergent you will take out of the detergent drawer and other washing agents.

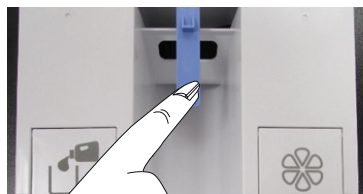

- Press the blue part in the middle of the detergent drawer and then pull the drawer towards yourself to take it out.



- Take out the discharge bar that is located at the back of the drawer.
- The hole behind the detergent compartment that will be emptied is placed over a container.
- Slightly push the discharge bar into the slot at the back of the detergent compartment.
- The detergent starts to flow to the container.
- Repeat the same process for softener.

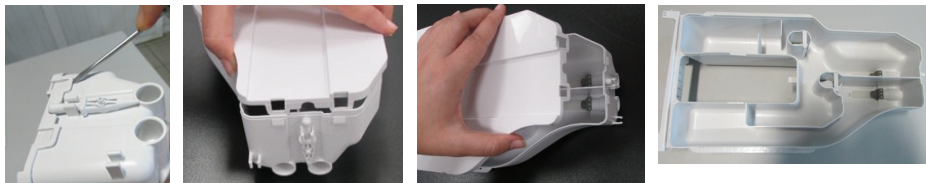

- Use a flat screwdriver to remove the tabs holding the upper cover of the detergent drawer (there are 6 tabs in total: two on the right side of the drawer, two on the left and two at the back) and wash the inside of the drawer.
- After washing it, place the cover back to its location. Make sure that all tabs are fitted. If the tabs do not seat properly, liquids may leak or the detergent drawer may get stuck or difficultly move on the drawer slide. For this reason, please ensure that the tabs are fitted in place.
- Fit the discharge bar to its slot at the back of the drawer.
- Paying attention to its slot and slides, fit the drawer back in place and push it to close. After adding detergent and softener, it will be ready to be used in programmes with dosing function.

4.4.2 Cleaning the loading door and the drum

For products with drum cleaning programme, please see Operating the product - Programmes.



Repeat Drum Cleaning process in every 2 months.

Use an anti-limescale suitable for the washing machines.



After every washing make sure that no foreign substance is left in the product.

If the holes on the bellow shown in the figure is blocked, open the holes using a toothpick.

Foreign metal substances will cause rust stains in the drum. Clean the stains on the drum surface by using cleaning agents for stainless steel.

Never use steel wool or wire wool. These will damage the painted, chromated and plastic surfaces.

4.4.3 Cleaning the body and control panel

Wipe the body of the product with soapy water or non-corrosive mild gel detergents as necessary, and dry with a soft cloth.

Use only a soft and damp cloth to clean the control panel.

4.4.4 Cleaning the water intake filters

There is a filter at the end of each water intake valve at the rear of the product and also at the end of each water intake hose where they are connected to the tap. These filters prevent foreign substances and dirt in the water to enter the product. Filters should be cleaned if they are dirty.

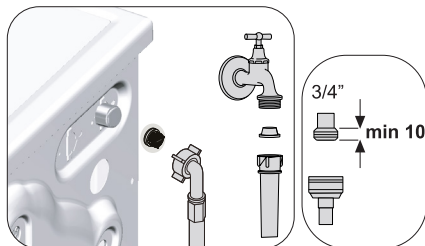

1. Close the taps.
2. Remove the nuts of the water intake hoses to access the filters on the water intake valves. Clean them with an appropriate brush. If the filters are too dirty, remove them from their places with a pliers and clean in this way.
3. Take out the filters on the flat ends of the water intake hoses together with the gaskets and clean thoroughly under running water.
4. Replace the gaskets and filters carefully and tighten their nuts by hand.

4.4.5 Draining remaining water and cleaning the pump filter

The filter system in your product prevents solid items such as buttons, coins and fabric fibers clogging the pump impeller during draining of washing water. Thus, the water will be drained without any problem and the service life of the pump will extend.

If the product fails to drain water inside it, the pump filter is clogged. Filter must be cleaned whenever it is clogged or in every 3 months. Water must be drained off first to clean the pump filter.

In addition, prior to transporting the product (e.g., when moving to another house) water should be drained completely.



WARNING: Foreign substances left in the pump filter may damage your product or may cause noise problem.

WARNING: In regions where freezing is possible, the tap must be closed, system hose must be removed and the water inside the product must be drained when the product is not in use.

WARNING: After each use, turn off the tap to which the mains hose is connected.

In order to clean the dirty filter and drain the water:

- 1 Unplug the product to cut off the supply power.



WARNING: Temperature of the water inside the product may rise up to 90 °C. To avoid the risk of scalding, clean the filter after the water inside the product is cooled down.

- 2 Open the filter cover.

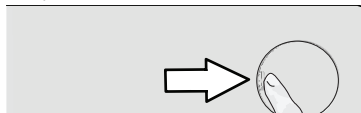

3 Follow the below procedures in order to drain water.

If the product has an emergency water draining hose, in order to drain the water:

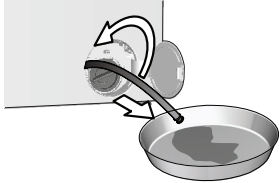
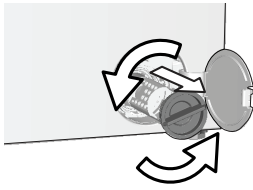

- a Pull the emergency draining hose out from its seat.
- b Place a large container at the end of the hose. Drain the water into the container by pulling out the plug at the end of the hose. When the container is full, block the inlet of the hose by replacing the plug. After the container is emptied, repeat the above procedure to drain the water in the product completely.
- c When draining of water is finished, close the end by the plug again and fix the hose in its place.
- d Turn and remove the pump filter.

4 Clean any residues inside the filter as well as fibers, if any, around the pump impeller region.

5. Replace the filter.

6. If the filter cap is composed of two pieces, close the filter cap by pressing on the tab. If it is one piece, seat the tabs in the lower part into their places first, and then press the upper part to close.

5 Troubleshooting





Please read the "Safety Instructions" section first!

Problem	Cause	Solution
Programs do not start after the loading door is closed.	Start / Pause / Cancel button is not pressed.	<ul style="list-style-type: none"> • *Press Start / Pause / Cancel button.
	It may be difficult to close the loading door in case of excessive loading.	<ul style="list-style-type: none"> • Reduce the amount of laundry and make sure that the loading door is closed properly.
Programme cannot be started or selected.	The product has switched to self protection mode due to a supply problem (line voltage, water pressure, etc.).	<ul style="list-style-type: none"> • Press and hold On/Off button for 3 seconds to reset the product to factory settings. (See "Cancelling the programme")
Water inside the product.	Some water has remained in the product due to the quality control processes in the production.	<ul style="list-style-type: none"> • This is not a failure; water is not harmful to the product.
The product does not take water in.	Tap is turned off.	<ul style="list-style-type: none"> • Turn on the taps.
	Water inlet hose is bent.	<ul style="list-style-type: none"> • Flatten the hose.
	Water inlet filter is clogged.	<ul style="list-style-type: none"> • Clean the filter.
	Loading door is not closed.	<ul style="list-style-type: none"> • Close the door.
The product does not drain water.	Water drain hose is clogged or twisted.	<ul style="list-style-type: none"> • Clean or flatten the hose.
	Pump filter is clogged.	<ul style="list-style-type: none"> • Clean the pump filter.
Product vibrates or makes noise.	Product is standing unbalanced.	<ul style="list-style-type: none"> • Stable the product by adjusting the feet.
	A hard substance has entered into the pump filter.	<ul style="list-style-type: none"> • Clean the pump filter.
	Transportation safety bolts are not removed.	<ul style="list-style-type: none"> • Remove the transportation safety bolts.
	Laundry quantity in the product is too little.	<ul style="list-style-type: none"> • Add more laundry to the product.
	Excessive laundry is loaded in the product.	<ul style="list-style-type: none"> • Take out some of the laundry from the product or distribute the load by hand to balance it homogeneously in the product.
There is water leaking from the bottom of the product.	Product is leaning on a rigid item.	<ul style="list-style-type: none"> • Make sure that the product is not leaning on anything.
	Water drain hose is clogged or twisted.	<ul style="list-style-type: none"> • Clean or flatten the hose.
Product stopped shortly after the programme started.	Pump filter is clogged.	<ul style="list-style-type: none"> • Clean the pump filter.
	Machine has stopped temporarily due to low voltage.	<ul style="list-style-type: none"> • Product will resume running when the voltage restores to the normal level.
Product directly drains the water it takes in.	Draining hose is not at adequate height.	<ul style="list-style-type: none"> • Connect the water draining hose as described in the user manual.
No water can be seen in the product during washing.	Water is inside the invisible part of the product.	<ul style="list-style-type: none"> • This is not a failure.
Loading door cannot be opened.	Loading door lock is activated because of the water level in the product.	<ul style="list-style-type: none"> • Drain the water by running the Pump or Spin programme.
	Product is heating up the water or it is at the spinning cycle.	<ul style="list-style-type: none"> • Wait until the programme completes.
	Loading door may be stuck because of the pressure it is subjected to.	<ul style="list-style-type: none"> • Grab the handle and push and pull the loading door to release and open it.
	If there is no power, loading door of the product will not open.	<ul style="list-style-type: none"> • To open the loading door, open the pump filter cap and pull down the emergency handle positioned at the rear side of the said cap. See "Loading door lock"

Problem	Cause	Solution
Washing takes longer than specified in the user manual. (*)	Water pressure is low.	<ul style="list-style-type: none"> Product waits until taking in adequate amount of water to prevent poor washing quality due to the decreased amount of water. Therefore, the washing time extends.
	Voltage is low.	<ul style="list-style-type: none"> Washing time is prolonged to avoid poor washing results when the supply voltage is low.
	Input temperature of water is low.	<ul style="list-style-type: none"> Required time to heat up the water extends in cold seasons. Also, washing time can be lengthened to avoid poor washing results.
	Number of rinses and/or amount of rinse water have increased.	<ul style="list-style-type: none"> Product increases the amount of rinse water when good rinsing is needed and adds an extra rinsing step if necessary.
	Excessive foam has occurred and automatic foam absorption system has been activated due to too much detergent usage.	<ul style="list-style-type: none"> Use recommended amount of detergent.
Programme time does not countdown. (On models with display) (*)	Timer may stop during water intake.	<ul style="list-style-type: none"> Timer indicator will not countdown until the product takes in adequate amount of water. The product will wait until there is sufficient amount of water to avoid poor washing results due to lack of water. Timer indicator will resume countdown after this.
	Timer may stop during heating step.	<ul style="list-style-type: none"> Timer indicator will not countdown until the product reaches the selected temperature.
	Timer may stop during spinning step.	<ul style="list-style-type: none"> Automatic unbalanced load detection system is activated due to the unbalanced distribution of the laundry in the product.
Programme time does not countdown. (*)	There is unbalanced load in the product.	<ul style="list-style-type: none"> Automatic unbalanced load detection system is activated due to the unbalanced distribution of the laundry in the product.
Product does not switch to spinning step. (*)	There is unbalanced load in the product.	<ul style="list-style-type: none"> Automatic unbalanced load detection system is activated due to the unbalanced distribution of the laundry in the product.
	The product will not spin if water is not drained completely.	<ul style="list-style-type: none"> Check the filter and the draining hose.
	Excessive foam has occurred and automatic foam absorption system has been activated due to too much detergent usage.	<ul style="list-style-type: none"> Use recommended amount of detergent.
Washing performance is poor: Laundry turns gray. (**)	Insufficient amount of detergent has been used over a long period of time.	<ul style="list-style-type: none"> Use the recommended amount of detergent appropriate for water hardness and the laundry.
	Washing has been made at low temperatures for a long time.	<ul style="list-style-type: none"> Select the proper temperature for the laundry to be washed.
	Insufficient amount of detergent is used with hard water.	<ul style="list-style-type: none"> Using insufficient amount of detergent with hard water causes the soil to stick on the cloth and this turns the cloth into gray in time. It is difficult to eliminate graying once it happens. Use the recommended amount of detergent appropriate for water hardness and the laundry.
	Excessive amount of detergent is used.	<ul style="list-style-type: none"> Use the recommended amount of detergent appropriate for water hardness and the laundry.
Washing performance is poor: Stains persist or the laundry is not whitened. (**)	Insufficient amount of detergent is used.	<ul style="list-style-type: none"> Use the recommended amount of detergent appropriate for water hardness and the laundry.
	Excessive laundry is loaded in.	<ul style="list-style-type: none"> Do not load the product in excess. Load with amounts recommended in the "Programme and consumption table".
	Wrong programme and temperature were selected.	<ul style="list-style-type: none"> Select the proper programme and temperature for the laundry to be washed.
	Wrong type of detergent is used.	<ul style="list-style-type: none"> Use original detergent appropriate for the product.
	Excessive amount of detergent is used.	<ul style="list-style-type: none"> Put the detergent in the correct compartment. Do not mix the bleaching agent and the detergent with each other.

Problem	Cause	Solution
Washing performance is poor: Oily stains appeared on the laundry. (**)	Regular drum cleaning is not applied.	<ul style="list-style-type: none"> • Clean the drum regularly. For this procedure, please see "Cleaning the loading door and the drum".
Washing performance is poor: Clothes smell unpleasantly. (**)	Odours and bacteria layers are formed on the drum as a result of continuous washing at lower temperatures and/or in short programmes.	<ul style="list-style-type: none"> • Leave the detergent drawer as well as the loading door of the product ajar after each washing. Thus, a humid environment favorable for bacteria cannot occur in the machine.
Colour of the clothes faded. (**)	Excessive laundry was loaded in.	<ul style="list-style-type: none"> • Do not load the product in excess.
	Detergent in use is damp.	<ul style="list-style-type: none"> • Keep detergents closed in an environment free of humidity and do not expose them to excessive temperatures.
	A higher temperature was selected.	<ul style="list-style-type: none"> • Select the proper programme and temperature according to the type and soiling degree of the laundry.
Washing machine does not rinse well.	The amount, brand and storage conditions of the detergent used are inappropriate.	<ul style="list-style-type: none"> • Use a detergent appropriate for the washing machine and your laundry. Keep detergents closed in an environment free of humidity and do not expose them to excessive temperatures.
	Detergent was put in the wrong compartment.	<ul style="list-style-type: none"> • Add the detergent and the softener to the right compartment.
	Pump filter is clogged.	<ul style="list-style-type: none"> • Check the filter.
	Drain hose is folded.	<ul style="list-style-type: none"> • Check the drain hose.
Laundry became stiff after washing. (**)	Insufficient amount of detergent is used.	<ul style="list-style-type: none"> • Using insufficient amount of detergent for the water hardness can cause the laundry to become stiff in time. Use appropriate amount of detergent according to the water hardness.
	Detergent was put in the wrong compartment.	<ul style="list-style-type: none"> • Add the detergent and the softener to the right compartment.
	Detergent was mixed with the softener.	<ul style="list-style-type: none"> • Do not mix the softener with detergent. Wash and clean the drawer with hot water.
Laundry does not smell like the softener. (**)	Detergent was put in the wrong compartment.	<ul style="list-style-type: none"> • Add the detergent and the softener to the right compartment.
	Detergent was mixed with the softener.	<ul style="list-style-type: none"> • Do not mix the softener with detergent. Wash and clean the drawer with hot water.
	Softener dosing setting level is low.	<ul style="list-style-type: none"> • Increase the softener dosing amount by one level. See "Auto Dosing Setting"
Detergent residue in the detergent drawer. (**)	Detergent was put in wet drawer.	<ul style="list-style-type: none"> • Dry the detergent drawer before putting in detergent.
	Detergent has gotten damp.	<ul style="list-style-type: none"> • Keep detergents closed in an environment free of humidity and do not expose them to excessive temperatures.
	Water pressure is low.	<ul style="list-style-type: none"> • Check the water pressure.
	The detergent in the main wash compartment got wet while taking in the prewash water. Holes of the detergent compartment are blocked.	<ul style="list-style-type: none"> • Check the holes and clean if they are clogged.
	There is a problem with the detergent drawer valves.	<ul style="list-style-type: none"> • Call the Authorised Service Agent.
	Detergent was mixed with the softener.	<ul style="list-style-type: none"> • Do not mix the softener with detergent. Wash and clean the drawer with hot water.
	Regular drum cleaning is not applied.	<ul style="list-style-type: none"> • Clean the drum regularly. For this procedure, please see "Cleaning the loading door and the drum".
Too much foam forms inside the product. (**)	Improper detergents for the washing machine is used.	<ul style="list-style-type: none"> • Use detergents appropriate for the washing machine.
	Excessive amount of detergent is used.	<ul style="list-style-type: none"> • Use only sufficient amount of detergent.
	Detergent was stored under improper conditions.	<ul style="list-style-type: none"> • Store detergent in a closed and dry location. Do not store in excessively hot places.
	Some meshed laundry such as tulle may foam too much because of their texture.	<ul style="list-style-type: none"> • Use smaller amounts of detergent for this type of item.
	Detergent was put in the wrong compartment.	<ul style="list-style-type: none"> • Put the detergent in the correct compartment.

Problem	Cause	Solution
Foam is overflowing from the detergent drawer.	Too much detergent is used.	<ul style="list-style-type: none"> • Mix 1 tablespoonful softener and ½ l water and pour into the main wash compartment of the detergent drawer. • Put detergent into the product suitable for the programmes and maximum loads indicated in the "Programme and consumption table". When you use additional chemicals (stain removers, bleaches and etc), reduce the amount of detergent.
Laundry remains wet at the end of the programme. (*)	Excessive foam has occurred and automatic foam absorption system has been activated due to too much detergent usage.	<ul style="list-style-type: none"> • Use recommended amount of detergent.
(*) The product does not switch to spinning step when the laundry is not evenly distributed in the drum to prevent any damage to the product and to its surrounding environment. Laundry should be rearranged and re-spun.		
(**) Regular drum cleaning is not applied. Clean the drum regularly. See "Cleaning the loading door and the drum".		
	WARNING: If you cannot eliminate the problem although you follow the instructions in this section, consult your dealer or the Authorised Service Agent. Never try to repair a nonfunctional product yourself.	

	WARNING: Check the HomeWhiz section for the relevant troubleshooting information.
--	--

DISCLAIMER / WARNING (EN)

Some (simple) failures can be adequately handled by the end-user without any safety issue or unsafe use arising, provided that they are carried out within the limits and in accordance with the following instructions (see the "Self-Repair" section).

Therefore, unless otherwise authorized in the "Self-Repair" section below, repairs shall be addressed to registered professional repairers in order to avoid safety issues. A registered professional repairer is a professional repairer that has been granted access to the instructions and spare parts list of this product by the manufacturer according to the methods described in legislative acts pursuant to Directive 2009/125/EC.

However, only the service agent (i.e. authorized professional repairers) that you can reach through the phone number given in the user manual/warranty card or through your authorized dealer may provide service under the guarantee terms. Therefore, please be advised that repairs by professional repairers (who are not authorized by Grundig) shall void the guarantee.

Self-Repair

Self-repair can be done by the end-user with regard to the following spare parts: door, door hinge and seals, other seals, door locking assembly and plastic peripherals such as detergent dispensers (an updated list is also available in support.grundig.com as of 1st of March 2021).

Moreover, to ensure product safety and to prevent risk of serious injury, the mentioned self-repair shall be done following the instructions in the user manual for self-repair or which are available in support.grundig.com. For your safety, unplug the product before attempting any self-repair.

Repair and repair attempts by end-users for parts not included in such list and/or not following the instructions in the user manuals for self-repair or which are available in support.grundig.com, might give raise to safety issues not attributable to Grundig, and will void the warranty of the product.

Therefore, it is highly recommended that end-users refrain from the attempt to carry out repairs falling outside the mentioned list of spare parts, contacting in such cases authorized professional repairers or registered professional repairers. On the contrary, such attempts by end-users may cause safety issues and damage the product and subsequently cause fire, flood, electrocution and serious personal injury to occur.

By way of example, but not limited to, the following repairs must be addressed to authorized professional repairers or registered professional repairers: motor, pump assembly, main board, motor board, display board, heaters etc.

The manufacturer/seller cannot be held liable in any case where end-users do not comply with the above.

The spare part availability of the washing machine or washer-dryer that you purchased is 10 years. During this period, original spare parts will be available to operate the washing machine or washer-dryer properly.

