

TCL

3.1.2 Channel Dolby Atmos Sound Bar with Wireless Subwoofer

8132 Series

User Manual



Contents

1	Before you begin	3
2	Welcome	4
	What's in the box	4
	Overview of the Sound Bar	6
	Overview of the wireless subwoofer	8
	Set up your Sound Bar system	9
	Position Your Sound Bar and Subwoofer	9
	Mount your Sound Bar on the wall	10
	Install/replace the remote control batteries.....	14
	Overview of the Remote Control	15
3	Connect your Sound Bar system	17
	Connect with the HDMI cable	17
	Optional: Connect your Blu-ray player	19
	Connect with the optical cable	20
	Direction for setting up your Sound Bar using an optical cable	21
	Connect your Sound Bar to power supply	22
	Connect the Sound Bar with your Bluetooth device	23
	Connect your wireless subwoofer to the Sound Bar	24

4 Use your Sound Bar system.....	25
Use your Sound Bar with the top panel or remote control	25
Listen to music from your Bluetooth device	28
Use the USB cable or device for music playback	29
<hr/>	
5 Specifications	30
<hr/>	
6 Notice	31
Declaration of conformity	31
Disposal of your old product and battery	31
Trademarks	33
<hr/>	
7 FAQ	34

1 Before you begin

- Carefully read and observe all safety instructions in the safety leaflet.
- This soundbar is intended for indoor use only. In case it accidentally gets in contact with small amounts of water, unplug immediately and use a dry cloth to remove the water.
- Unplug the soundbar if it is not used for long periods of time or during lightning storms.
- Make sure the soundbar is installed on a solid surface or solidly wall-mounted below your TV for the best experience.
- Only use AAA 1.5V non-rechargeable batteries for the remote control.
- In case any of the cables are visibly damaged or pinched, unplug the soundbar and replace the cable.
- Be careful not to sharply bend the HDMI and optical cable as they may affect the performance.
- Protect your hearing by adjusting to a proper volume. Predefined and customizable sound settings are available for your listening comfort.

2 Welcome

Congratulations on the purchase of your new TCL Sound Bar! After it is set up and connected, you can experience a superb sound quality and state-of-the-art design to best fit your home entertainment system. You are recommended to read through this user manual which helps you set up, connect and operate the product easily and properly.

Let's get started.

What's in the box

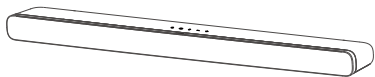

Sound Bar

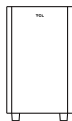

Wireless Subwoofer



Remote control



AAA battery x 2



AC power cord x 2

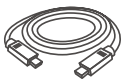

HDMI cable

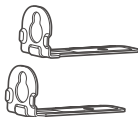

Wall mount bracket x 2



Wall mounting screw x 2



Wall anchor x 2

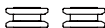

Sleeve x 2



Quick Start Guide





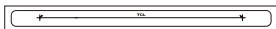

Safety leaflet

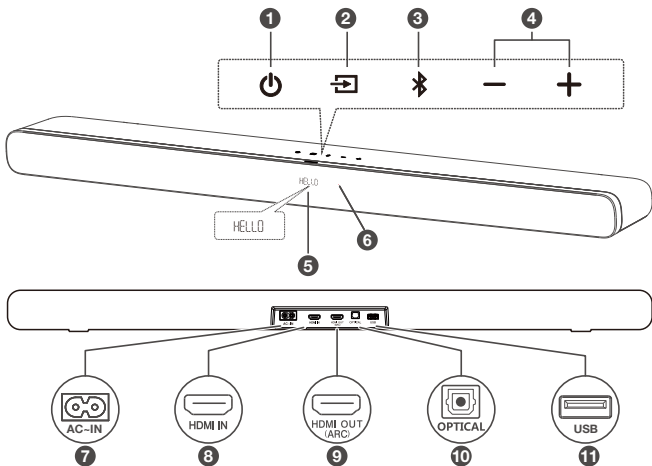

Wall mount template

Overview of the Sound Bar



- 
Short press to enter Sleep or Standby mode.
Long press to enter Standby mode.
- 
Press to switch the audio source among
HDMI ARC/HDMI IN/OPT/BT/USB modes.
- 
Press to select the Bluetooth function. Press and hold
to enter the pairing mode.

4 **+ / -**

Press to increase or decrease the volume level.

5 **LED indicator**

It indicates the Sound Bar status (e.g. volume level, sound bar status).

6 **White LED:**

It indicates standby/sleep mode.

7 **AC input power connector**

8 **HDMI IN connector**

9 **HDMI OUT (ARC) connector**

10 **Optical input connector**

11 **USB Type A connector (only for music playback)**

Overview of the wireless subwoofer

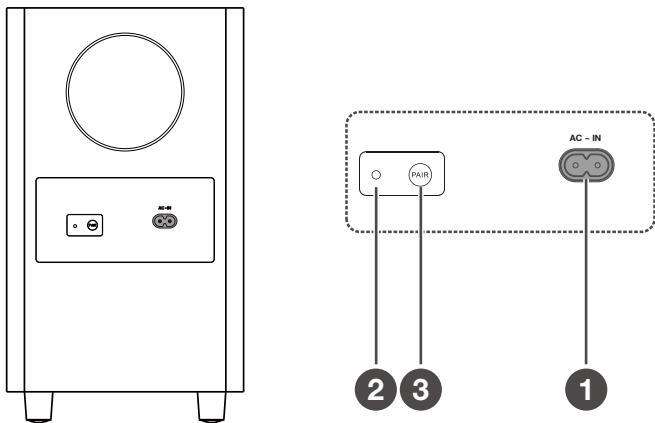

1 AC input power connector

2 Amber LED indicator

- flashes slowly when the subwoofer is in standby mode.
- flashes quickly when pairing is in progress.
- remains on solidly when pairing is successful.

3 PAIR

Press and hold  button on the Sound Bar main unit for 5 seconds. Press and hold **PAIR** button on the subwoofer till the pairing finished. And then the amber LED keep lighting up on the subwoofer.

Note

- The subwoofer is already paired at the factory. Manually pairing is needed only in case of troubleshooting.

Set up your Sound Bar system

Notes

- Make sure you read all the safety information before you mount the Sound Bar main unit on the wall.
- Make sure you use screws provided or specified by the authorized manufacturer.
- TCL Overseas Marketing Limited bears no responsibility for accidents or damage caused by improper wall mounting and screws installation or insufficient wall strength, etc.
- Additional tools (not supplied) are required for installation.
- You can choose to place your Sound Bar below the center of your TV or mount it on the wall.

Position Your Sound Bar and Subwoofer

The ideal place to position the Sound Bar main unit is centered underneath your TV.

You are recommended to place the Sound Bar main unit on the top of the cabinet and right below the center of your TV. The distance between the subwoofer and the Sound Bar main unit should be less than 3 meters.

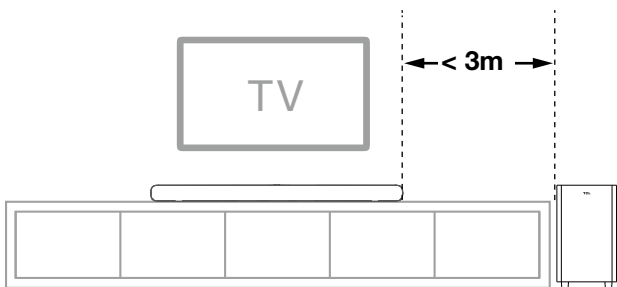

Mount your Sound Bar on the wall

- 1 Place the supplied wall mount template on the wall. Make sure the wall mount template is at least 5cm below the center of the TV.
- 2 Use a level to make sure the wall mount template is positioned accurately.
- 3 Use the tape to stick the wall mount template firmly on the wall.

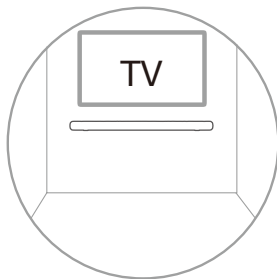

- 4 Mark on the wall using each marking on the template through the mounting holes.
- 5 Take away the wall mount template.
- 6 Drill a screw hole at each marking on the wall.

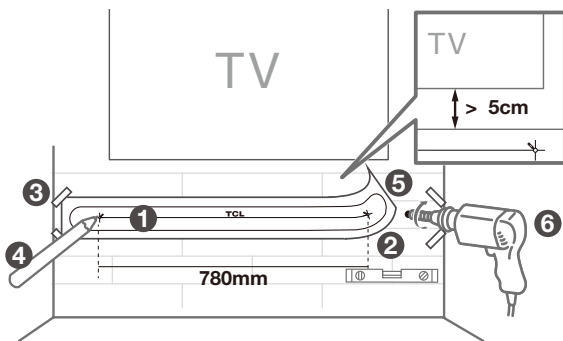

- 7 Screw off the rubber cushions from the soundbar.
(Reserve the rubber cushions for future use)
 - * The rubber cushions can be used as soundbar mats when you put the soundbar on the table
- 8 Screw on the wall mount brackets to the soundbar.
- 9 Insert the supplied screws with the sleeves into the hole of the wall anchors.

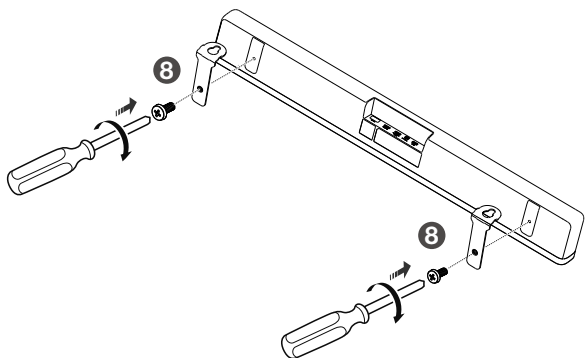
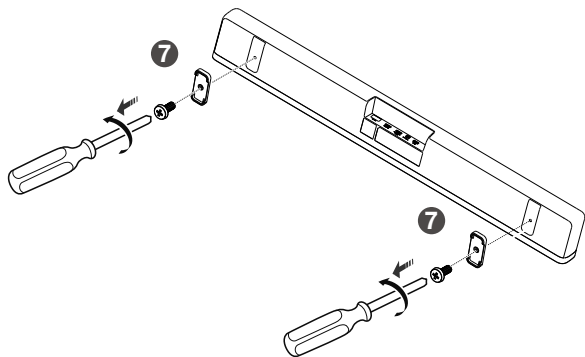

- 10 Fix and tighten the wall bracket screws on the wall.
- 11 Hang the Sound Bar on the screws.

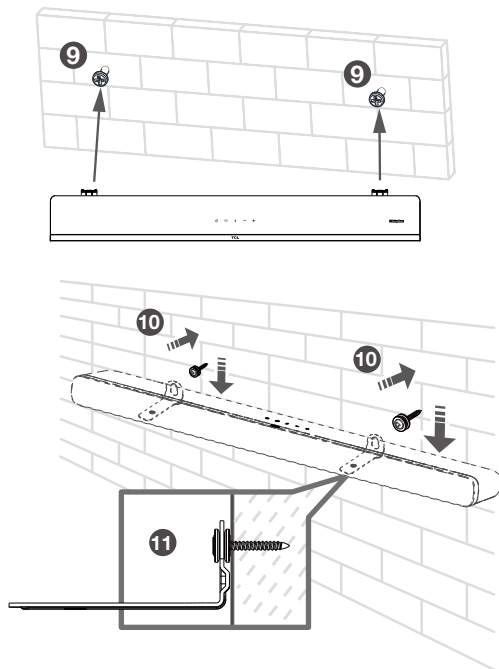

Notes

- Check the installation location before you mount the Sound Bar on the wall (see 'Mount your Sound Bar on the wall' on page 10).
- You may consider to connect the cables first before mounting the Sound Bar on the wall.

Install/replace the remote control batteries

Warnings

- *Danger of explosion if battery is incorrectly replaced. Replace only with the same or equivalent type.*

Caution

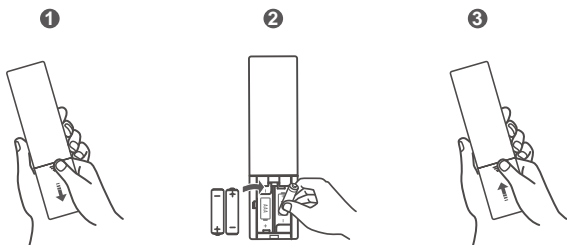

- The battery contains perchlorate material, handle it with care. For information, refer to www.dtsc.ca.gov/hazardouswaste/perchlorate
- 1 Open the battery compartment, remove the old batteries if necessary.
 - 2 Place two new AAA batteries into the battery compartment with the correct polarity (+/-).
 - 3 Close the battery compartment.





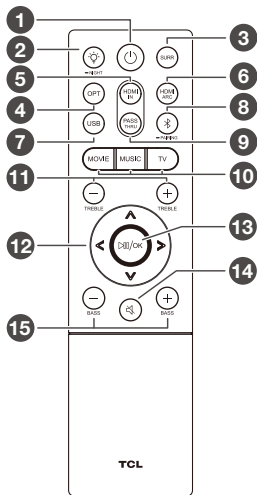



Setup is complete. Your Sound Bar is ready to use. For more information about how to access different connection options on your Sound Bar, see the following chapter.

Overview of the Remote Control



- 1  Short press to enter Sleep or Standby mode.
Long press to enter Standby mode.
- 2  Press to adjust the lightness of the display.
Press and hold for 3 seconds to enter Night mode or close Night mode.
- 3 SURR
Press to turn on/off Dolby vertical surround.
- 4 OPT
Press to switch the audio source to Optical mode.
- 5 HDMI IN
Press to switch the audio source to HDMI IN source.

- 6 **HDMI ARC**
Press to switch the audio source to HDMI OUT (ARC) source.
- 7 **USB**
Press to switch the audio source to USB source.
- 8 
Press to switch the audio source to Bluetooth mode.
Press and hold to enter pairing mode.
- 9 **PASS THRU**
Press to switch on/off Pass Through function.
- 10 **MOVIE / MUSIC / TV**
Press to select the equalizer (EQ) effect when you are watching **TV**, **movie** or listening to **music**.
- 11 **TREBLE + / -**
Increase or decrease the treble sound effect.
- 12 
Switch to previous or next music. (Under Bluetooth or USB mode)
- 
Decrease or increase the volume level.
- 13 /OK
Press to play/pause the music. (Under Bluetooth or USB mode)
In Standby or Sleep mode, press and hold for 5 seconds to enter Menu, and then press / to view options. And press OK to confirm.
- 14 
Press to mute or unmute the sound.
- 15 **BASS + / -**
Increase or decrease the bass sound effect.

3 Connect your Sound Bar system

After you have fixed the position of the Sound Bar, you can start connecting it to your TV or other devices and listen to the audio through your Sound Bar. Make sure you have muted the audio of your TV or device. For information, check the user manual of your TV or device.

Connect with the HDMI cable

Note

- Make sure your TV or device supports the HDMI ARC feature. For information, check the user manual of your TV or device.

Connect one end of the HDMI cable to the HDMI ARC input connector on your Sound Bar and another end to the HDMI ARC output connector of your TV or device.

To get the best possible audio experience using the HDMI cable, follow below given steps:

- 1 Connect your Sound Bar to HDMI input marked **(ARC)** on your TCL TV.
- 2 Press the **Settings** button on your TCL TV remote.
- 3 Navigate to System options.
- 4 Set T-Link to **On**. (This feature may be called, Anynet+, SimpLink, BRAVIA Link, EasyLink or VIERA Link*.)

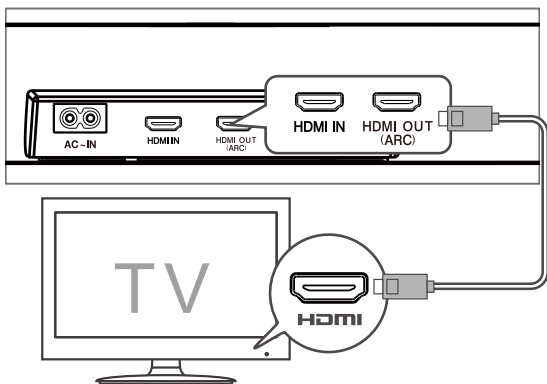

★ All technology names mentioned are the trademarks or registered trademarks of their respective companies.

Optional: Connect your Blu-ray player

For ease of use, you are advised to connect a Blu-ray player to the TV and enjoy the Sound Bar through HDMI-ARC. However, in order to enjoy **Dolby TrueHD** based **Atmos** content that not all TVs may support through HDMI-ARC, you can optionally connect your Blu-ray player directly to the Sound Bar using the HDMI-in port.

Notes

- The Sound Bar will pass on the video signal to the TV. If it is not successful, turn on the Sound Bar and try again.
- The HDMI input supports UHD (4K) and that it can also be used for game console to enjoy Dolby Atmos audio.

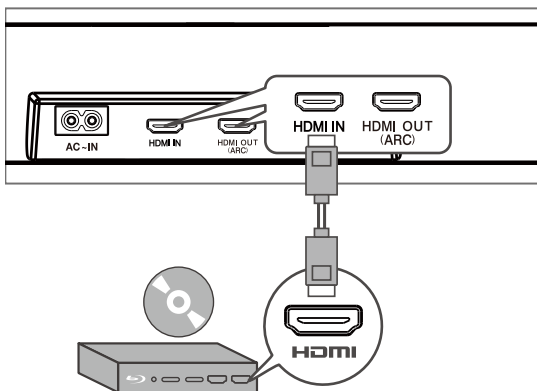

Connect with the optical cable

- 1 Remove the protective caps from the optical cable when necessary.
- 2 Connect one end of the optical cable to the optical input connector on your Sound Bar and another end to the optical output connector of your TV or device.

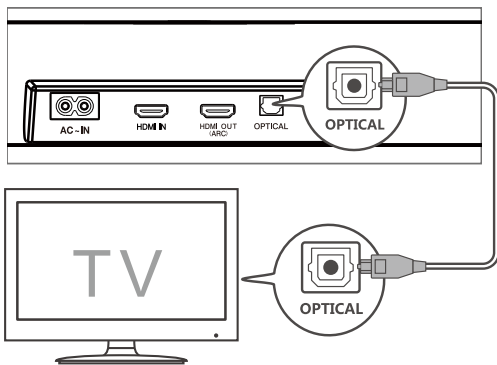

Note

- If there is no sound output from the Sound Bar, try to activate the PCM signal output on your TV or device. PCM is used to convert analog audio signals into digital audio signals in most devices. For more information of how to activate the PCM signal output, check the user manual of your TV or device.

Direction for setting up your Sound Bar using an optical cable



Do not bend or kink the optical cable (SPDIF) as it is fragile and can easily get damaged and broken.

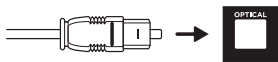

To get the best possible audio experience using the optical cable:

- 1 Press the Home button on your TCL TV Remote.
- 2 Navigate to **Audio option** under **Settings**.
- 3 Uncheck the “**TV speaker enabled**” option.
- 4 Under **S/PDIF** and **ARC**, select **PCM-Stereo**.

Notes

- *Different devices may have different menu options.*
- *Devices such as Blu-ray players, set-top boxes, etc. are also applicable.*

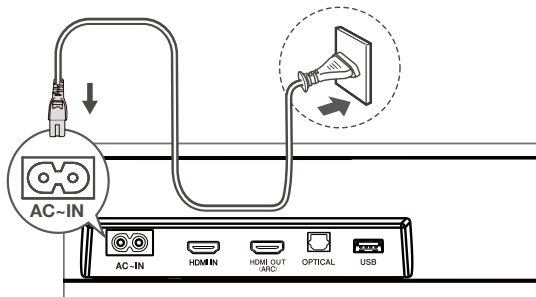

Connect your Sound Bar to power supply

- 1 Make sure that you have completed all other connections before connecting the Sound Bar to power supply.
- 2 Make sure the power supply voltage complies with your country's safety standards (see 'Specifications' on page 29)
- 3 Connect one end of a supplied AC power cord to the AC input connector on your Sound Bar and another end to the power socket on the wall.



Connect the Sound Bar with your Bluetooth device

Notes



- Make sure your wireless device supports the Bluetooth function.
 - The operational range between the Sound Bar and your Bluetooth device is approximately 10 meters (without any obstacle between the Bluetooth device and the Sound Bar).
- 1 Press  on the top panel of your Sound Bar or remote control to power on the Sound Bar.
 - 2 Press and hold  on the top panel of your Sound Bar or remote control.
→ PAIR is flashes on the LED display. The Sound Bar is ready to pair.
 - 3 Power on your Bluetooth device and activate its Bluetooth function.
 - 4 Select **TCL 8132 Sound Bar** on the pairing list of your Bluetooth device.
→ You hear distinct double beep sound.

Tip

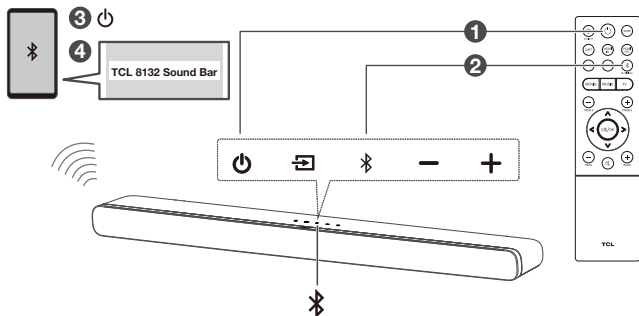
- If you cannot find the model name **TCL 8132 Sound Bar** on your Bluetooth device, press and hold  on the remote control. You will see PAIR . Now the Sound Bar is coming into the pairing mode.



Your Sound Bar system is now set up and ready to be used.

- 5 To disconnect the Bluetooth function, you can:
- press  on the Sound Bar or remote control to switch to another source; or
 - disable the Bluetooth function on your device; or
 - press and hold  on the remote control for 3 seconds.

Connect your wireless subwoofer to the Sound Bar

When the wireless subwoofer is connected, you can enjoy powerful deep bass sounds and a truly immersive audio experience.

Auto pairing

Make sure both the Sound Bar and wireless subwoofer are connected to the power supply and are turned on.

- The Sound Bar will pair with the subwoofer automatically.
- The amber LED will flash when pairing is in progress.
- The amber LED will remain on solidly when pairing is successful.

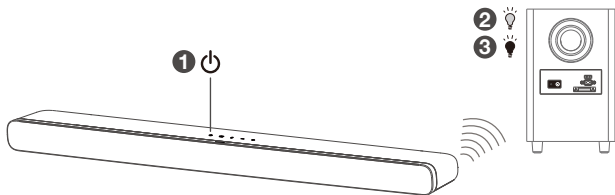

If you have devices more than one to be connected, please connect the next one after connecting the previous one successfully.

4 Use your Sound Bar system

Use your Sound Bar with the top panel or remote control

- 1 Make sure the Sound Bar is properly connected to the power supply and sources.
- 2 Press  at the top panel of your Sound Bar main unit or remote control to switch to the correct source.

LED behaviors under different source modes

	Sound Bar status	LED display
Power	Power on	HELLO
	Standby	STDBY
	Sleep	SLEEP
	Sleep mode	<ul style="list-style-type: none"> • White LED flashes slowly
	Standby mode	<ul style="list-style-type: none"> • White LED
Source	HDMI IN	HDMI 1 IN
	HDMI ARC	HDMI 2 ARC
	USB	USB
	BLUETOOTH	BT
	OPTICAL	OPT
Bluetooth	Normal	BT
	Pairing mode	PAIR
USB	Normal	USB
	Plug off USB device	NOUSB
	Play	Show playing time
	Pause	PAUSE
OPT	Normal	OPT
	Audio format	PCM AUDIO/DOLBY SURROUND
HDMI	Normal	HDMI
	Audio format	PCM AUDIO/DOLBY ATMOS/ DOLBY SURROUND

ARC(eARC)	Normal Audio format	ARC PCM AUDIO/DOLBY ATMOS/ DOLBY SURROUND
Audio Setting	Volume display Max & Min Volume Mute Treble Bass Vertical Surround EQ Setup Night Setup DIM Setup	V 22 V MAX/V MIN MUTE TRE-3 ~ TRE+3 BAS-3 ~ BAS+3 SURR ON/SURR OFF MOVIE/MUSIC/TV NIGHT DIM 1(100%)/DIM 2(50%)
Menu	Sleep mode switch Factory Reset	SLEEP ON/SLEEP OFF FACTORY RESET



Note

- After powering on your Sound Bar, if there is no operation performed on either the Sound Bar or remote control within 10 seconds, all LED indicators on the Sound Bar will turn off and light up again when the operation is resumed.
You can use more advanced functions on the remote

Tip

- You can use more advanced functions on the remote control (see 'Overview of the remote control' on page 15).

Listen to music from your Bluetooth device

- 1 Make sure that your device supports A2DP and/or AVRCP. For information, check the specification of your device.
- 2 Pair your Bluetooth device with the Sound Bar (see 'Connect the Sound Bar with your Bluetooth device' on page 23).
- 3 Start listening to music stored in your Bluetooth device through the Sound Bar.
 - If your Bluetooth device supports A2DP, you can listen to music, but you cannot control the playback.
 - If your Bluetooth device supports AVRCP, you can listen to music and control music playback with the remote control. Press  to pause or resume music playback. Press  /  to skip to the previous/next track.

Note

- The operational range between the Sound Bar and your Bluetooth device is approximately 10 meters (without any obstacle between the Bluetooth device and Sound Bar).

Use the USB cable or device for music playback

- Press **▶/OK** on the remote control to listen to/pause/resume the music.
- Press **◀** or **▶** on the remote control to skip to the previous or next track.
- Press **▲** or **▼** to increase or decrease the volume level.

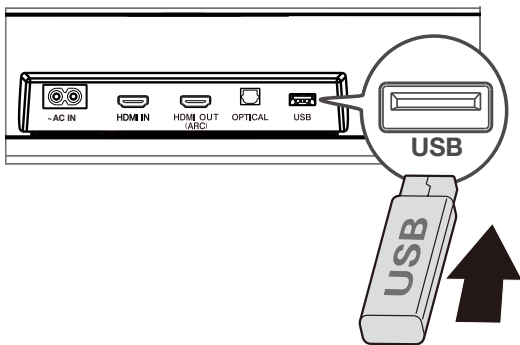

Tip

- This Sound Bar can support USB devices of up to 64GB memory and the supported file format is MP3.
- Musics in folders of the USB device should be within 5 (including 5) directory levels. Otherwise, the sound bar can not detect the musics.

5 Specifications

Product Name

3.1.2 Channel Dolby Atmos Sound Bar with Wireless Subwoofer

Sound Bar

- Power Supply: AC 100-240V ~ 50/60Hz
- Power consumption: 30W
- Power consumption at standby mode: $\leq 0.5W$
- Impedance: 6 Ω
- Frequency response: 160Hz-20KHz
- Dimensions (WxHxD): 39.4"x2.6"x4.8" / 1000x65x122mm
- Weight: 7.3 lbs (3.3 kg)
- Operating temperature: 0°C - 45°C

Wireless subwoofer

- Power Supply: AC 100-240V ~ 50/60Hz
- Power consumption: 30W
- Power consumption at standby mode: $\leq 0.5W$
- Frequency response: 40 Hz-120 Hz
- Frequency range: 5732MHz-5848MHz
- Max transmitting power: 13dBm
- Dimensions (WxHxD): 7.9"x13.8"x7.9" / 200x350x200mm
- Weight: 7.7 lbs (3.5 kg)

Bluetooth

- Bluetooth version: 5.0, Bluetooth profile - Bluetooth stereo supported (Advanced Audio Distribution Profile - A2DP; Audio Video Remote Control Profile - AVRCP)
- Frequency range: 2402 Mhz – 2480 Mhz
- Max transmitting power: 15dBm

Remote control

- Distance/Angle: 6m/ 30°
- Battery type: 1.5V AAA battery x 2, user replaceable.

Wi-Fi

WLAN Standard	IEEE802.11a/b/g/n/ac
Security	WPA2™/WPA™

Frequency range	2.4 GHz band (1-13 ch)/5 GHz band
For EU	2412 MHz to 2472 MHz 5180 MHz to 5320 MHz 5500 MHz to 5700 MHz 5745 MHz to 5850 MHz
Maximum power(EIRP)	20 dBm

6 Notice

Declaration of conformity

Hereby, TCL Overseas Marketing Limited declares that this radio equipment is in compliance with Directive 2014/53/EU and the relevant UK statutory requirements. The full text of the declaration of conformity is available at the following internet address: <http://www.tcl.com> go to Support and enter the model name. This equipment may be operated in all EU countries and in the UK.

Restrictions in the 5 GHz band:

The 5150 to 5350 MHz frequency range is restricted to indoor use only in: AT, BE, BG, CH, CY, CZ, DE, DK, EE, EL, ES, FI, FR, HR, HU, IE, IS, IT, LI, LT, LU, LV, MT, NL, NO, PL, PT, RO, SE, SI, SK, TR, UK(NI).

In accordance with the relevant statutory requirements in UK, the 5150 to 5350 MHz frequency range is restricted to indoor use only in the United Kingdom.

Disposal of your old product and battery



Your product is designed and manufactured with high quality materials and components, which can be recycled and reused.



This symbol on a product means that the product is covered by European Directive 2012/19/EU.



This symbol means that the product contains a battery covered by European Directive 2013/56/EU which cannot be disposed of with normal household waste. Inform yourself about the local separate collection system for electrical and electronic products and batteries. Follow local rules and never dispose of the product and batteries with normal household waste. Correct disposal of old products and batteries helps prevent negative consequences for the environment and human health.

Remove the disposable battery

To remove the disposable batteries, see the section ‘Replace the remote control battery’.

Environmental protection and sustainability

We have omitted all unnecessary packaging and make sure it is eco-friendly and sustainable.

Trademarks



The Bluetooth® word mark and logos are registered trademarks owned by Bluetooth SIG, Inc. and any use of such marks by TTE Corporation is under license. Other trademarks and trade names are those of their respective owners.



Dolby, Dolby Atmos, and the double-D symbol are registered trademarks of Dolby Laboratories Licensing Corporation. Manufactured under license from Dolby Laboratories. Confidential unpublished works. Copyright © 2012-2021 Dolby Laboratories. All rights reserved.



The Adopted Trademarks HDMI, HDMI High-Definition Multimedia Interface, and the HDMI Logo are trademarks or registered trademarks of HDMI Licensing Administrator, Inc. in the United States and other countries.

COMPATIBLE WITH



Dolby, Dolby Vision, Dolby Atmos, and the double-D symbol are registered trademarks of Dolby Laboratories Licensing Corporation. Manufactured under license from Dolby Laboratories. Confidential unpublished works. Copyright © 2012–2020 Dolby Laboratories. All rights reserved.



Amazon, Alexa and all related logos are trademarks of Amazon.com, Inc. or its affiliates.

7 FAQ

No power

- Make sure the AC power cord and AC input connector are connected properly.
- Make sure there is power supply.
- Make sure the Sound Bar has turned on.

No sound

- Make sure the audio cable is connected to the Sound Bar and your device.
- Make sure you have selected the correct source.
- Press **▲** to increase the volume level.
- Make sure the Sound Bar is not muted.

Low voice

- Use the remote control to adjust the volume.
- May open Night mode, please press  for 3 seconds to exit the Night mode.

* Other EQs cannot be selected in Night Mode.

The remote control does not work.

- Make sure you have selected the correct source.
- Make sure the distance of remote control and the Sound Bar is within operational range.
- Make sure the battery is correctly inserted and is working.
- Make sure the remote control is close to the remote control sensor of the Sound Bar.

I hear distorted sound.

- Make sure all cables are properly connected.
- Make sure you have selected the correct source.
- Make sure the TV is muted if you play audio from the TV.

I cannot find the Bluetooth name of this Sound Bar on my Bluetooth device.

- Make sure the Bluetooth function is activated on your Bluetooth device.
- Make sure the Sound Bar has paired with your Bluetooth device.

TCL support:

Please visit www.tcl.com

**WE ARE
READY TO
HELP** contact us first
with any questions



**TAKE CARE WHEN
REMOVING THE SOUND BAR**