



## Safety

Ensure that your domestic mains supply voltage matches the voltage indicated on the identification sticker located at the back of your set. Where the mains plug, AC inlet or an appliance coupler is used as disconnect device, it shall remain readily operable.

On certain models, the light indicator is located at the side of the TV set. The absence of a light indication at the front does not mean that the TV set is fully disconnected from the mains. To disconnect the TV set completely, the mains plug must be pulled out.

The TV set's components are sensitive to heat. The **maximum ambient temperature** should not exceed **35°** Celsius. Do not cover the vents at the back or sides of the TV set. Leave sufficient space around it to allow adequate ventilation. Install the appliance away from any source of heat (fireplace, etc.) or appliances creating strong magnetic or electric fields.

**Moisture** in rooms where the set is installed should not exceed **75%** humidity. Moving the set from a cold place to a warm one can cause condensation on the screen (and on some components inside the TV set). Let the condensation evaporate before switching the TV set on again.

The  or **POWER**/ button on the TV set or the  button on the remote control can be used to switch it on and put it into standby mode. If you are **not going to be watching the TV for a lengthy period of time**, switch it off completely by removing the plug from the mains power socket.

During **thunderstorms**, we recommend that you disconnect the TV set from the mains and aerial so that it is not affected by electrical or electromagnetic surges that could damage it. For this reason, keep the **mains and aerial sockets** accessible so they can be **disconnected**, if necessary.

**Unplug** the TV set immediately if you notice it giving off a **smell of burning** or **smoke**. You must never, under any circumstances, open the TV set yourself, as you run the risk of an **electric shock** in doing so.

## WARNINGS

This appliance is intended for domestic household use only and should not be used for any other application, such as for non-domestic use or in a commercial environment.

If the external flexible cable or cord of this product is damaged, it shall be replaced by the manufacturer or his service agent or a similar qualified person in order to avoid a hazard.

Leave more than 10cm clearance around the television to allow adequate ventilation. The ventilation should not be impeded by covering the ventilation openings with items, such as newspapers,

table-cloths, curtains, etc.

The apparatus shall not be exposed to dripping or splashing and no objects filled with liquids, such as vases shall be placed on the apparatus.

Batteries (battery pack or batteries installed) shall not be exposed to excessive heat such as sunshine, fire or the like.

To reduce the risk of fire or electric shock, do not expose this apparatus to rain or moisture.

Never place a television set in an unstable location. A television set may fall, causing serious personal injury or death. Many injuries, particularly to children, can be avoided by taking simple precautions such as:

- Using cabinets or stands recommended by the manufacturer of the television set.
- Only using furniture that can safely support the television set.
- Ensuring the television set is not overhanging the edge of the supporting furniture.
- Not placing the television set on tall furniture (for example, cupboards or bookcases) without anchoring both the furniture and the television set to a suitable support.
- Not placing the television set on cloth or other materials that may be located between the television set and supporting furniture.
- Educating children about the dangers of climbing on furniture to reach the television set or its controls.

If your existing television set is being retained and relocated, the same considerations as above should be applied.

Equipment with this symbol is a Class II or double insulated electrical appliance. It has been designed in such a way that it does not require a safety connection to electrical earth.



Equipment without this symbol is a Class I electrical appliance. It shall be connected to a mains socket outlet with a protective earthing connection.



To prevent the spread of fire, keep candles or other open flames away from this product at all times.



This symbol indicates that high voltage is present inside. It is dangerous to make any kind of contact with any internal part of this product.



This symbol indicates that the fuse may be in the neutral, and that the mains shall be disconnected to de-energize the phase conductors.

To prevent injury, this apparatus must be securely attached to the floor/wall in accordance with the installation instructions.

To reduce the risk of RF exposure, the use distance of this apparatus should be at least 100cm.

If an outside antenna or cable system is connected to the product, be sure the antenna or cable system is grounded by a skilled person so as to provide some protection against voltage surges and built-up static charges.

### **TV screen**

The TV screen used in this product is made of glass. Therefore, it can break when the product is dropped or impacted upon by other objects.

The TV screen is a very high technology product, giving you finely detailed pictures. Occasionally, a few nonactive pixels may appear on the screen as a fixed point of blue, green or red. This does not affect the performance of your product.

### **Care**

Use a glass-cleaning product to clean the screen and a soft cloth and mild detergent to clean the rest of the set.

**Important:** Using strong detergents, alcohol-based and abrasive products may damage the screen.

Dust the vents at the back and sides regularly. Using solvents, abrasive or alcohol-based products could damage the TV set. If an object or liquid enters the appliance, unplug it immediately and have it checked by an authorized engineer. Never open the appliance yourself since this may put you at risk or damage the appliance.

### **ESD regulation**

This apparatus meets ESD performance criteria.

In case the apparatus does not recover in Ethernet connection mode due to electrostatic discharge, user interference is required.

### **Hanging the TV set on the wall**

**Warning: This operation requires two people.**

To ensure a safe installation, observe the following safety notes:

- Check that the wall can support the weight of the TV set and wall mount assembly.
- Follow the mounting instructions provided with the wall mount. For certain models, make sure to screw the hexagonal VESA wall mounting screw bosses (and screws) provided with the set into the nuts for the wall mount at the back of your set before your wall mounting.
- The TV set must be installed on a vertical wall.

- Make sure to use only screws suitable for the material of the wall.
- Make sure that the TV set cables are placed so that there is no danger of tripping over them.

All other safety instructions about our TV sets are also applicable here.

### **Multi product user manual**

The features described in this manual are common to most models. Some features may not be available on your TV and/or your TV may include features that are not described in this user manual. The illustrations in this manual may differ from the actual product. Please refer to the actual product.

**Information for Users on Disposal of Old Equipment and Batteries**

**[European Union]**



Products

These symbols indicate that the electrical and electronic equipment and the battery with this symbol should not be disposed of as general household waste at their end-of-life. Instead, the products should be handed over to the applicable collection points for the recycling of electrical and electronic equipment as well as batteries for proper treatment, recovery and recycling in accordance with your national legislation and the Directive 2012/19/EU, 2006/66/EC and 2008/12/EC.



Battery

**Notice:**  
The sign Pb below the symbol for batteries indicates that this battery contains lead.

By disposing of these products correctly, you will help to conserve natural resources and will help to prevent potential negative effects on the environment and human health which could otherwise be caused by inappropriate waste handling of these products.

For more information about collection points and recycling of these products, please contact your local municipal office, your household waste disposal service or the shop where you purchased the product.

Penalties may be applicable for incorrect disposal of this waste, in accordance with national legislation.

**[Business users]**

If you wish to dispose of this product, please contact your supplier and check the terms and conditions of the purchase contract.

**[Other Countries outside the European Union]**

These symbols are only valid in the European Union. If you wish to dispose of these items, please do so in accordance with applicable national legislation or other rules in your country for the treatment of old electrical equipment and batteries.

**Dear Customer,**

Hereby, TCL declares that this device is in compliance with Directive 2014/53/EU. The full text of the EU declaration of conformity is available at the following internet address: [www.tcl.com](http://www.tcl.com)

The EU declaration of conformity can be downloaded directly at [www.tcl.eu/eu/doc/XXXXXXXXX](http://www.tcl.eu/eu/doc/XXXXXXXXX) \*

\* Please replace «XXXXXXXXX» by the exact model name.

*Figures and illustrations in this User Manual are provided for reference only and may differ from actual product appearance. Product design and specifications may be changed without notice.*

# Contents

Important information .....	1	Picture .....	11
<b>Chapter 1 - Connections</b>		Music .....	11
Connect the power and antenna .....	5	Movie .....	11
Connect Blu-ray Disc player, HD camcorder, HD game console, PC, headphones, CI module .....	5	<b>Chapter 5 - Other information</b>	
<b>Chapter 2 - Getting started</b>		Password in Parental Control.....	13
Remote control functions .....	6	Troubleshooting .....	13
Switch the TV on and off.....	7		
Initial setup .....	7		
<b>Chapter 3 - Basic TV operations</b>			
Accessing channels .....	8		
Watching connected devices .....	8		
Adjusting Volume .....	8		
Using TV settings menu .....	8		
Selecting menu language .....	8		
<b>Chapter 4 - Using more of your TV</b>			
Installing channels .....	9		
Common interface .....	9		
Using the common interface module .....	9		
Accessing common interface services .....	9		
Using EPG (Electronic Programme Guide) .....	9		
Channel diagnostics.....	9		
Using subtitles .....	10		
Turning on/off subtitles .....	10		
Enabling subtitle languages on digital TV channels .....	10		
Selecting a subtitle type on digital TV channels	10		
Using Teletext .....	10		
Selecting decoding page language .....	10		
Digital Teletext language .....	10		
T-Link .....	10		
Enabling or disabling T-Link .....	10		
Using one-touch play .....	10		
Using system standby .....	10		
Customising the input settings .....	11		
Changing to shop or home mode .....	11		
Software update .....	11		
Reset shop .....	11		
Viewing pictures, playing music and watching movies from a USB storage device.....	11		

# Chapter 1 - Connections

## Connect the power and antenna

To switch on TV after connecting power cord, press  $\text{\textcircled{P}}$  or **POWER/**.

Notes:

- Position of power socket varies according to TV model.
- Disconnect the power cord before connecting devices.

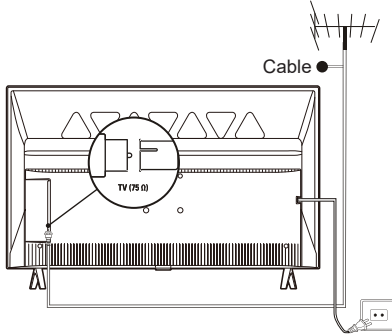

## Connect Blu-ray Disc player, HD camcorder, HD game console, PC, headphones, CI module

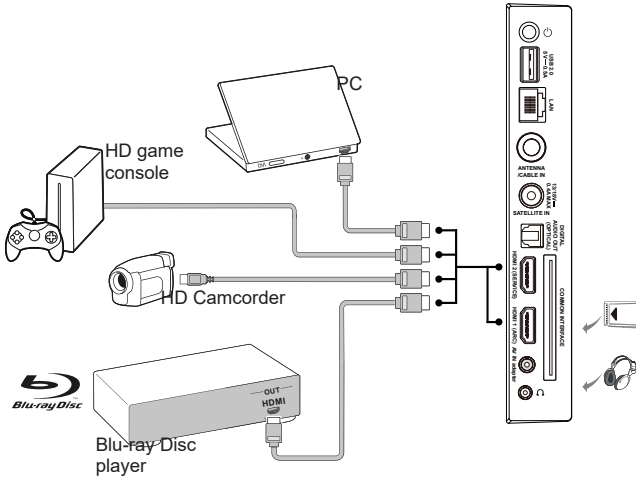

Notes:

- Not all connections available on all models.
- The positions and names of the function buttons and connectors on the TV may vary according to TV model.
- Before connecting a PC, set the PC monitor refresh rate to 60Hz.
- It is recommended to use as short as possible high quality HDMI cables to avoid possible interferences.
- ARC (Audio Return Channel) function is only supported on the HDMI port identified with ARC.
- USB connector is for data input from USB storage devices.
- All USB devices have to be directly connected to TV set without cable extenders. In case extender is required it has to be as short as possible and equipped with ferrite beads.

## Chapter 2 - Getting started

### Remote control functions

Most of your television's functions are available via the menus that appear on the screen. The remote control supplied with your set can be used to navigate through the menus and to configure all the general settings.

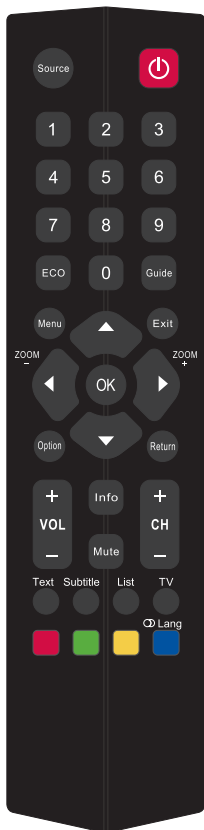

**Source** To select connected devices.

⓪ Standby/quit standby.

**Numeric buttons** To enter channel numbers or a digit.

**ECO** To turn ECO mode on or off.

**Guide** To toggle the Electronic Programme Guide on or off (only available for digital channels).

**Menu** To access the main menu; to return to the previous menu.

**Exit** To exit the menu or Teletext.

▲ ▼ To navigate in the main menu; to select menu options; to switch to the previous or next photo, song or video in USB function.

◀ ▶ To navigate in the main menu; to set functions and change values. ▶ can also be used to open the corresponding submenu.

**\*Zoom+/-**

\* To select the picture format.

*Note: You are recommended to use the full screen mode. Do not use the display mode with black bars on both sides of the picture (such as 4:3) for a long time, otherwise the TV screen may be damaged permanently.*

**OK** To open the corresponding submenu and activate a setting in menus; to freeze/unfreeze the picture in digital TV mode.

**Option** To display the function menu to perform certain operations; to display the Teletext menu in Teletext page.

**Return** To return to the previous channel or menu.

**VOL+/-** To control the volume.

**Info** To display programme information, if available.

**Mute** To switch the sound off and back on.

**CH+/-** To change channels.

**Text** To toggle Teletext on or off.

**Subtitle** To select a subtitle language available for selected digital TV programme.

**List** To display channel list.

**TV** To access TV mode.

**Colour buttons** To select tasks or Teletext pages.

⓪ **Lang** To select an audio language available for selected digital TV programme.

*Note: The remote control type may be changed without notice.*

**Important:**

Batteries shall not be exposed to excessive heat such as sunshine, fire or the like. Remove batteries when the remote control is not to be used for a long time. Batteries left in equipment may cause damage through deterioration and corrosive leakage, invalidating the guarantee.

To protect the environment use local recycling facilities for battery disposal. Dispose of used batteries according to the instructions.

**CAUTION:** Risk of explosion if batteries are replaced by an incorrect type. Replace only with the same or equivalent type recommended by the equipment manufacturer.

If the batteries in your remote control are run down, you can use the buttons on your TV set. They have the following functions:

For models with below buttons on the set:

 **VOL-/◀**

 **VOL+/▶**





 Features (Short press)

 (Long press)

For models with below button on the set:

 Power on/Standby

**Switch the TV on and off**

1. When the power cord is connected, the TV will be turned on directly or be in standby mode. If the TV is in standby mode, press the  or **POWER**/ button on the set or the  button on the remote control to turn it on.
2. To put the TV into standby mode, press the  button on the remote control. The TV set remains powered up, but with low energy consumption.
3. To switch the TV off, unplug the mains plug from the mains outlet.

**Initial setup**

The first time you switch the set on, the **Hello** screen appears, which guides you through the initial setup process. Follow the on-screen instructions to finish the initial setup process such as selecting the language, scanning channels, and more. During each step, either make a choice or skip the step. If you skip a step, you can perform the setup later from the settings menu.

*Note: If the channel search retrieved only the analogue channels it could be caused by poor broadcasting and therefore is not covered by manufacturer warranty. Manufacturers cannot be held responsible for lack of or poor broadcasting in some areas.*

## Accessing channels

**Using the numeric buttons:** press the corresponding numeric buttons on the remote control to access the channels.

**Using the CH+/- buttons:** press the CH+/- buttons on the remote control or the corresponding buttons on the TV set to scroll through the channels.

**Using the List button:** press the List button on the remote control to display the channel list and press ▲/▼ to select the channels, then press OK to confirm.

## Watching connected devices

Select connected devices via three ways below:

- Press **Menu** to display the main menu, press ▲/▼/◀/▶ to select the input source, then press **OK** to enter.
- Press **Source** to display the **Input Source** menu, press ▲/▼ and **OK** to select the input source.
- You can also press the corresponding buttons on the TV set to scroll through TV and other input sources.

Press **Source** again or **Exit** to close the menu.

## Adjusting Volume

**Volume control:** press the VOL+/- buttons on the remote control or the corresponding buttons on the TV set to increase or decrease the volume.

**Sound mute:** press the **Mute** button to temporarily mute the sound. Press this button again or the **VOL+** button to restore it.

## Using TV settings menu

Allows you to adjust TV settings, such as picture and sound.

1. Press **Menu** to display the main menu.
2. Press ▲/▼/◀/▶ to select **Settings** and press **OK** to display the Settings menu.
3. Press ▲/▼ to select the desired item, then press **OK/▶** to enter the corresponding submenu.
4. In submenus, press ▲/▼ to select menu options, then press **OK/▶** to enter the option list, the adjustment interface, or the corresponding submenu.
5. Press **Return** to go back to the previous menu.
6. Press **Exit** to close the menu.

*Note: You can also press the **Option** button on the remote control to select **Settings** and press **OK** to enter the Settings menu. Some options may not be available for certain signal sources.*

## Selecting menu language

Allows you to select your preferred menu language.

1. Press **Menu** to display the main menu.
2. Press ▲/▼/◀/▶ to select **Settings** and press **OK**, use ▲/▼ to select **System**, and press **OK/▶** to enter.
3. Select **Menu language** and press ▲/▼ to select your desired language, then press **OK** to confirm.
4. Press **Exit** to close the menu.



## Installing channels

This section describes how to search and store channels automatically. This may be done in any of the cases below:

- you have skipped the channel installation step in the initial setup;
- you are prompted that there are no channels in TV mode;
- you want to update your channels.

1. In TV mode, press **Menu** to display the main menu, use **▲/▼/◀/▶** to select **Settings** and press **OK**. Press **▲/▼** to select **Channel > Channel scan**, then press **OK/▶** to enter.
2. The TV installs and arranges channels according to your country. Press **▲/▼** to select **Country**, and press **OK/▶** to enter. Enter the default password 1234 or your own password in case you have changed the password in the **Settings > Lock > Change password** menu. Press **▲/▼** to select your country and press **OK** to confirm.
3. Press **▲/▼** to select **Automatic search** and press **OK/▶** to enter.
4. Press **▲/▼** to select **Tuner mode** and press **◀/▶** to select **Antenna**, **Cable** or **Satellite**. (Note: *Satellite option may not be available for certain models.*)
5. Press **▲/▼** to select other options to configure.
6. After configuration is completed, press **▼** to select **Search** and press **OK** to start scanning channels.
7. The search may take a few minutes. After the automatic search, channels are arranged in a preset order. If you wish to skip channels or set up your favorite channels, press the **Menu** button on the remote control, then press **▲/▼/◀/▶** to select **Settings > Channel > Channel organizer** and press **OK/▶** to enter.

## Common interface

Encrypted digital TV channels can be decoded with a common interface module and a card provided by a digital TV service operator.

The common interface module may enable several digital services, depending on the operator and services you choose (for example, pay TV). Contact your digital TV service operator for more information about services and terms.

### Using the common interface module

**WARNING: Switch off your TV before inserting a common interface module. Be sure to follow the instructions described below. Wrong insertion of a common interface module may damage both the module and your TV.**

1. Following the directions printed on the common interface module, gently insert the module into the common interface slot on the TV.
2. Push the module in as far as it will go.
3. Turn on the TV and wait for the common interface function to be activated. This may take several minutes.

*Note: Do not remove the common interface module from the slot. Removing the module will deactivate the digital services. This TV set has passed CI+ certification. It is recommended that you use a common interface module marked with CI+.*

### Accessing common interface services

After inserting and activating the common interface module, press **Menu** on the remote control, select **Settings > Channel > Common interface** and press **OK/▶** to enter.

This menu option is only available if the common interface module is correctly inserted and activated. On-screen applications and content are provided by your digital TV service operator.

## Using EPG (Electronic Programme Guide)

EPG is an on-screen guide that displays scheduled digital TV programmes. You can navigate, select and view programmes.

1. Press **Menu** on the remote control, select **Settings > Channel > EPG** and press **OK/▶** to enter, or press **Guide** on the remote control, the **Programme Guide** menu will appear, which allows you to get information about the current or next programme playing on each channel. Navigate through the different programmes using the **▲/▼/◀/▶** buttons on the remote control.
2. Use the related buttons shown on the screen to view EPG.
  - **Info**: press the green button to view the related information.
  - **Schedule**: press the yellow button to view your schedule list. Press the yellow button again to return to the previous menu, press the red button to delete the channel from the schedule list.
  - **Remind**: press the blue button to access **Set a reminder** menu, use **▲/▼** to select a reminder and press **OK** to confirm. Use **◀/▶** to set a customized reminder.
3. Press **Guide** or **Exit** to exit EPG.

## Channel diagnostics

1. Press **Menu** on the remote control, then select

**Settings > Channel > Channel diagnostics.**

2. Press **OK/▶** to display the signal information on the current digital channel, such as signal strength, frequency, etc.

**Using subtitles**

You can enable subtitles for each TV channel. Subtitles are broadcast via Teletext or DVB-T/DVB-C digital broadcasts. With digital broadcasts, you have the additional option of selecting a preferred subtitle language.

**Turning on/off subtitles**

1. Press **Menu** on the remote control, select **Settings > Channel > Subtitle** and press **OK/▶** to enter.
2. Select the **Subtitle** option, press **OK/▶** to enter, press **▲/▼** to select **On** or **Off** and press **OK** to confirm.
3. Press **Exit** to close the menu.

**Enabling subtitle languages on digital TV channels**

1. Press **Menu** on the remote control, select **Settings > Channel > Subtitle > Digital subtitle language 1st** and press **OK/▶** to enter.
2. Press **▲/▼** to select a subtitle language as your preferred language and press **OK** to confirm.
3. Press **▲/▼** to select **Digital subtitle language 2nd** and press **OK/▶** to enter.
4. Press **▲/▼** to select a secondary subtitle language and press **OK** to confirm.
5. Press **Exit** to close the menu.

**Selecting a subtitle type on digital TV channels**

1. Press **Menu** on the remote control, select **Settings > Channel > Subtitle > Subtitle type** and press **OK/▶** to enter.
2. Press **▲/▼** to select a subtitle type and press **OK** to confirm. You can select **Hearing impaired** to display the hearing impaired subtitles with your selected language.
3. Press **Exit** to close the menu.

**Using Teletext****Selecting decoding page language**

1. Press **Menu** on the remote control, select **Settings > Channel > Teletext > Decoding page language** and press **OK/▶** to enter.

2. Press **▲/▼** to select a proper type of language in which Teletext will display and press **OK** to confirm.
3. Press **Exit** to close the menu.

**Digital Teletext language**

On digital TV channels, depending on the broadcaster, you may be able to enjoy a service with multiple initial Teletext pages in different languages. This function allows you to select an available language as primary language, which relates to different initial Teletext pages.

1. Press **Menu** on the remote control, select **Settings > Channel > Teletext > Digital teletext language** and press **OK/▶** to enter.
2. Press **▲/▼** to select a language and press **OK** to confirm.
3. Press **Exit** to close the menu.

**T-Link**

Use this function to search for CEC devices connected to the HDMI sockets in your TV and enable one-touch play and one-touch standby between CEC devices.

**Enabling or disabling T-Link**

1. Press **Menu** on the remote control, select **Settings > System > T-Link** and press **OK/▶** to enter.
2. Press **▲/▼** to select **T-Link** and press **OK/▶** to enter.
3. Press **▲/▼** to select **On** or **Off** and press **OK** to confirm.
4. Press **Exit** to close the menu.

**Using Auto power on**

Enables the TV to automatically power on when you power on a CEC device (e.g. DVD) with the device's remote.

1. Press **Menu** on the remote control, select **Settings > System > T-Link** and press **OK/▶** to enter.
2. Press **▲/▼** to select **Setup > Auto power on** and press **OK/▶** to enter.
3. Press **▲/▼** to select **On** or **Off** and press **OK** to confirm.
4. Press **Exit** to close the menu.

**Using Auto standby**

Enables all CEC devices to automatically go to the standby mode when you turn off the TV with the TV remote.

1. Press **Menu** on the remote control, select **Settings > System > T-Link** and press **OK/▶** to enter.

2. Press ▲/▼ to select **Setup > Auto standby** and press **OK/▶** to enter.
3. Press ▲/▼ to select **On** or **Off** and press **OK** to confirm.
4. Press **Exit** to close the menu.

**Notes:**

- *The CEC functions depend on the devices connected and it is possible that some devices may not interoperate correctly when connected to this TV. The user manual or the manufacturer of the problematic devices should be consulted for further information.*
- *You can also press the **Option** button on the remote control to access **T-Link**.*

## Customising the input settings

You can configure your TV according to the equipment you connect to it.

1. Press **Menu** on the remote control, select **Settings > System > Input settings** and press **OK/▶** to enter.
2. Press ▲/▼ to select a connector your equipment is connected to, press **OK/▶** to enter.
3. Press ▲/▼ to select the type of apparatus attached to this connector, and press **OK** to confirm.
4. Press **Exit** to close the menu.

After configuring, the selected source label will be displayed after the name of the related connector in the input source list when pressing **Source** on the remote control or in the main menu when pressing **Menu** on the remote control.

## Changing to shop or home mode

1. Press **Menu** on the remote control, select **Settings > System > Location** and press **OK/▶** to enter.
2. Press ▲/▼ to select your location **Shop** or **Home**, and press **OK** to confirm.
3. Press **Exit** to close the menu.

*Note: According to the regulation of European Commission 2009/125/EC, in Home mode, TV will be put into standby mode automatically if there is no operation in 4 hours. Select **Settings > Time > Auto Standby** to deactivate this feature.*

## Software update

Use this function to update the software.

1. Press **Menu** on the remote control, select **Settings > System > Software update** and press **OK/▶** to enter.

2. Press ▲/▼ to select your desired way to update the software and press **OK/▶** to start.

## Reset shop

Allows you to reset the TV to factory default settings.

1. Press **Menu** on the remote control, select **Settings > System > Reset shop** and press **OK** to enter.
2. Use the numeric buttons to enter the password.
3. Press ◀/▶ to select **OK** and press **OK** to start.
4. The **Hello** screen appears. Follow the on-screen instructions.

## Viewing pictures, playing music and watching movies from a USB storage device

Your TV is fitted with USB connectors that enable you to view photos, listen to music or watch videos stored on a USB drive.

Supported file formats:

Picture	JPEG, PNG, BMP, GIF.
Music	MP3
Movie	H.265, H.264, MPEG1/2/4, VC1, AC3, AAC, HEAAC, LPCM.

**Notes:**

- *Some USB keys and USB products like digital cameras or mobile phones are not fully compatible with USB 2.0 standard so they may not work with the TV multimedia player. Not all USB keys or devices are compatible with the USB function. Not all above formats are recognised. The encoding formats of your files will determine whether or not they can be used.*
- *Format H.265 may not be available for certain models.*

To enter the **Media** menu, press **Source** on the remote control and select **Media**.

### Picture

Use this function to display photos, if available.

1. Select **Media > Picture**, then press **OK** to enter.
2. After selecting the proper disk, press **OK** to enter, then use ▲/▼/◀/▶ to select a photo.
3. Press **OK** to watch, a slide show begins from the selected photo. Press **OK** to pause. Press **Menu** to display the photo menu. You can play, pause or rotate the photo, select different play modes and display effects, etc.

### Music

Use this function to play music, if available.

1. Select **Media > Music**, then press **OK** to enter.
2. After selecting the proper disk, press **OK** to enter, then use **▲/▼/◀/▶** to select a song.
3. Press **OK** to play, and automatic playback begins from the selected song. Press **Menu** to display the music menu. You can play or pause the song, select different play modes, etc.

### **Movie**

Use this function to watch videos, if available.

1. Select **Media > Movie**, then press **OK** to enter.
2. After selecting the proper disk, press **OK** to enter, then use **▲/▼/◀/▶** to select a video.
3. Press **OK** to watch, and automatic playback begins from the selected video. Press **Menu** to display the video menu. You can play or pause the video, select different play modes, screen modes and preset picture settings, etc.

### Password in Parental Control

- The default password is 1234. You can change it to a new one.
- The super password is 0423. If you forget your code, enter the super password to override any existing codes.

### Troubleshooting

Please check the following list before requesting service.

#### There is no picture or sound.

- Make sure the power cord is properly inserted in the power outlet.
- Make sure the source type is set correctly.
- Make sure the antenna is properly connected.
- Make sure the volume is not set to minimum or the sound is not set to mute.
- Make sure the headphones are not connected.
- The TV may be receiving a signal other than from TV broadcasting stations.

#### Picture is not clear.

- Make sure the antenna cable is properly connected.
- Consider whether your TV signal is being properly received.
- Poor picture quality can occur due to a VHS camera, camcorder, or other peripheral being connected at the same time. Switch off one of the other peripherals.
- The 'ghost' or double image may be caused by obstruction to the antenna due to high-rise buildings or hills. Using a highly directional antenna may improve the picture quality.
- The horizontal dotted lines shown on the pictures may be caused by electrical interference, e.g., hair dryer, nearby neon lights, etc. Turn off or remove these.

#### Picture is too dark, too light or tinted.

- Check the colour adjustment.
- Check the brightness setting.
- Check the sharpness function.

#### Remote control does not work.

- Check the batteries of the remote control.
- Make sure the remote sensor window on the TV front is not under strong fluorescent lighting.
- Try to clean the remote sensor window on the TV front with a soft cloth.

If the above suggestions do not solve your technical issue, please refer to the warranty card for service information.

### Operating Conditions

Temperature 5°C - 35°C (41°F - 95°F)  
Humidity 20 - 75% (non-condensing)

### Storage Conditions

Temperature -15°C - 45°C (5°F - 113°F)  
Humidity 10 - 90% (non-condensing)

### OSS Notice

To send inquiries and requests for questions regarding open source, contact nearest TCL office.

This product uses the GPL (Version 2 and 3) and LGPL (version 2.1) and MPL (version 1.1).

This product uses some software programs which are distributed under the Independent JPEG Group.

This product uses some software programs which are distributed under the libpng Project.

This product uses some software programs which are distributed under the Freetype Project.

This product uses some software programs which are distributed under the zlib Project.

This product uses some software programs (curl, cares, xml2, pixman, iniparser, fastlz) which are distributed under the MIT.

This product uses openssl, xerces which is distributed under SSLeay and OpenSSL.

GPL software: Linux Kernel, iconv

LGPL software: DFB (DirectFB), glib, alsa, neon, pango, qt, glibc, uclibc

BSD software: webp, mng, uriparser