

COP827V
COP827X
EO82PBK



DA	Ovn
EN	Oven
FI	Uuni
IS	Ofn
NO	Ovn
SV	Inbyggnadsugn

Brugsanvisning	2
User Manual	41
Käyttöohje	80
Notendaleiðbeiningar	119
Bruksanvisning	158
Bruksanvisning	196

VELKOMMEN TIL ELECTROLUX! TAK, FORDI DU VALGTE VORES APPARAT.



I vores indsats for at være bæredygtige reducerer vi papirmaterialer og tilbyder komplette brugervejledninger på nettet. Få adgang til hele brugervejledningen på electrolux.com/manuals



Få rådgivning, brochurer, fejlfinding, service- og reparationsinformation på electrolux.com/support



Hent **My Electrolux Kitchen**-appen for flere opskrifter, tips og fejlfinding.



INDHOLDSFORTEGNELSE

1. OM SIKKERHED	4	6.5 Hjælp til tilberedning.....	17
1.1 Sikkerhed for børn og sårbare personer.....	4	7. URFUNKTIONER	21
1.2 Generel sikkerhed.....	4	7.1 Urfunktioner.....	21
2. SIKKERHEDSANVISNINGER	6	7.2 Sådan indstilles: Urfunktioner.....	22
2.1 Installation.....	6	8. BRUG AF TILBEHØRET	23
2.2 El-forbindelse.....	7	8.1 Isætning af tilbehør.....	23
2.3 Brug.....	7	8.2 Termometer.....	24
2.4 Vedligeholdelse og rengøring.....	8	9. EKSTRAFUNKTIONER	25
2.5 Pyrolyserengøring.....	8	9.1 Lås.....	25
2.6 Indvendig belysning.....	9	9.2 Automatisk slukning.....	26
2.7 Service.....	9	9.3 Køleblæser.....	26
2.8 Bortskaffelse.....	9	9.4 Mekanisk lågelås.....	26
3. PRODUKT BESKRIVELSE	10	9.5 Anvendelse: Mekanisk lågelås.....	27
3.1 Generelt overblik.....	10	10. RÅD OG TIPS	28
3.2 Tilbehør.....	10	10.1 Anbefalinger til tilberedning.....	28
4. BETJENINGSPANEL	11	10.2 Fugtig varmluft.....	28
4.1 Forsænkbare knapper.....	11	10.3 Fugtig varmluft - anbefalet tilbehør.....	28
4.2 Oversigt over betjeningspanel.....	11	10.4 Madlavningstabeller for testinstitutter.....	29
4.3 Skærm.....	12	11. VEDLIGEHOLDELSE OG RENGØRING	30
5. FØR BRUG FØRSTE GANG	12	11.1 Bemærkninger om rengøring.....	31
5.1 Indledende rengøring.....	13	11.2 Rengøring: Prægning i ovnrum.....	31
5.2 Indledende forvarmning.....	13	11.3 Fjernelse: Ovnribber.....	31
5.3 Trådløs forbindelse 	13	11.4 Anvendelse: Pyrolyserengøring.....	32
5.4 Softwarelicenser.....	14	11.5 Husk rengøring.....	33
6. DAGLIG BRUG	14	11.6	
6.1 Sådan indstilles: Ovnfunktioner.....	14	Sådan fjerner og installerer du: Låge.....	33
6.2 Ovnfunktioner.....	15	11.7 Udskiftning: Lampe.....	34
6.3 Bemærkninger til: Fugtig varmluft.....	16		
6.4 Sådan indstilles: Hjælp til tilberedning.....	16		

12. FEJLFINDING	35	13.2 Energibesparelse.....	38
12.1 Hvad gør du, hvis	36	14. MENUSTRUKTUR	39
12.2 Servicedata.....	37	14.1 Menu.....	39
13. ENERGIEFFEKTIV	37	15. MILJØHENSYN	40
13.1 Produktoplysninger og produktoplysningsark.....	37		

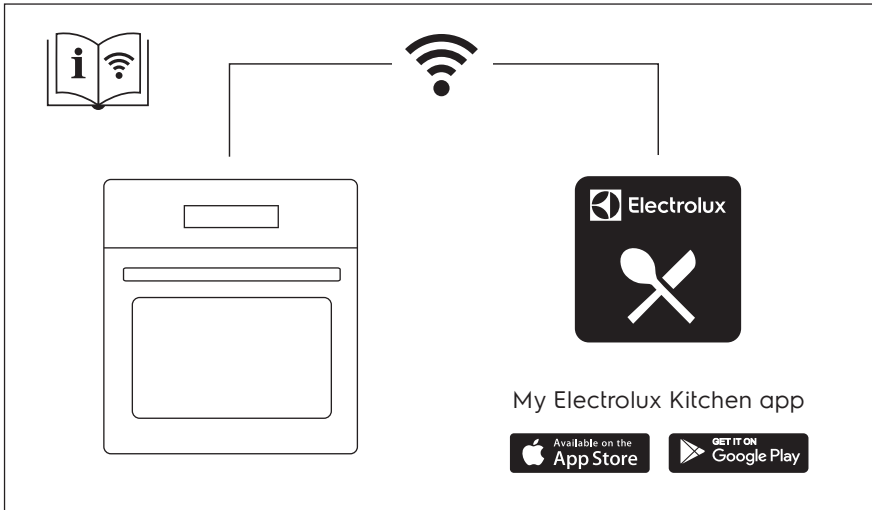

Ret til ændringer uden varsel forbeholdes.

1. ⚠️ OM SIKKERHED

Læs brugsanvisningen grundigt, før apparatet installeres og tages i brug. Producenten påtager sig intet ansvar for eventuelle skader, der er resultatet af forkert installation eller brug. Opbevar altid brugsanvisningen på et sikkert og tilgængeligt sted til senere opslag.

1.1 Sikkerhed for børn og sårbare personer

- Apparatet må kun bruges af børn fra 8 år og opefter samt af personer med nedsat fysisk, sensorisk eller psykisk funktionsevne, eller som mangler den nødvendige erfaring eller viden, hvis de er under opsyn eller er blevet instrueret i at bruge apparatet på en sikker måde samt forstår de farer, det indebærer. Børn under 8 år og personer med omfattende og komplekst handicap skal holdes på afstand af apparatet, medmindre de overvåges konstant.
- Børn skal holdes under opsyn for at sikre, at de ikke leger med apparatet og mobile enheder med My Electrolux Kitchen .
- Opbevar al emballage utilgængeligt for børn, og bortskaf det korrekt.
- ADVARSEL: Ovnen og de tilgængelige dele bliver meget varme under brug. Lad ikke børn og husdyr komme tæt på apparatet, mens det er i brug, eller når det køler af.
- Hvis apparatet har en børnesikring, skal den aktiveres.
- Børn må ikke udføre rengøring og vedligeholdelse på produktet uden opsyn.

1.2 Generel sikkerhed

- Dette apparat må kun anvendes til tilberedning af fødevarer.
- Dette apparat er beregnet til indendørs husholdningsbrug.
- Dette apparat kan bruges på kontorer, hotelværelser, bed & breakfast-værelser, stue- og gæstehuse og anden lignende

indkvartering, hvor en sådan brug ikke overstiger (gennemsnitlig) brugsniveauer i hjemmet.

- Kun en faguddannet installatør må installere apparatet og udskifte kablet.
- Brug ikke apparatet, inden det monteres i den indbyggede struktur.
- Før enhver vedligeholdelse skal apparatet kobles fra elnettet.
- Hvis strømledningen er beskadiget, skal den af sikkerhedsgrunde udskiftes af producenten, det autoriserede servicecenter eller en tekniker med tilsvarende kvalifikationer.
- **ADVARSEL:** Sørg for, at der er slukket for apparatet, inden pæren skiftes for at undgå elektrisk stød.
- **ADVARSEL:** Ovnen og de tilgængelige dele bliver meget varme under brug. Vær omhyggelig med at undgå at røre ved varmeelementer eller ovnrummets overflade.
- Brug altid ovnhandsker til at fjerne eller isætte tilbehør eller ovnartikler.
- Brug kun den anbefalede temperaturføler (termometer) til dette apparat.
- Træk først ovnribberne og derefter den bageste ende væk fra sidevæggene for at fjerne ovnribberne. Montér ovnribberne i modsat rækkefølge.
- Brug ikke damprensere til at rengøre apparatet.
- Brug ikke skrappe slibende rengøringsmidler eller skarpe metalskrabere til at rengøre glasset i kogesektionens hængslede låg. De kan ridse overfladen, med det resultat, at glasset knuses.
- Fjern al tilbehøret fra rummet i apparatet før pyrolyserengøring.

2. SIKKERHEDSANVISNINGER

2.1 Installation

**ADVARSEL!**

Apparatet må kun installeres af en sagkyndig.

- Fjern al emballagen.
- Undlad at installere eller bruge et beskadiget apparat.
- Følg installationsvejledningen, der følger med apparatet.
- Vær altid forsigtig, når du flytter apparatet, da det er tungt. Brug altid sikkerhedshandsker og lukket fodtøj.
- Træk aldrig i apparatet i håndtaget.
- Installér apparatet et sikkert og velegnet sted, der opfylder installationskrav.
- Mindsteafstanden til andre apparater og enheder skal overholdes.
- Før du monterer ovnen, skal du kontrollere, om ovnlågen åbner uden modstand.
- Apparatet er udstyret med et elektrisk afkølingssystem. Det skal betjenes med den elektriske strømforsyning.
- Indbygningsskabets stabilitet skal opfylde kravene i DIN 68930.

Kabinettets minimumshøjde (kabinets minimumshøjde under bordpladen)	578 (600) mm
Kabinet, bredde	560 mm
Kabinet, dybde	550 (550) mm
Højde foran på apparatet	594 mm
Højde bagest på apparatet	576 mm
Bredde foran på apparatet	595 mm
Bredde bagest på apparatet	559 mm
Apparatets dybde	567 mm
Apparatets indbygningsdybde	546 mm
Dybde med åben dør	1027 mm
Ventilationsåbning minimumsstørrelse. Åbning placeret på bundens bageste side	560x20 mm
Længden på ledninger til strømforsyning. Ledning placeret i højre hjørne af bagsiden	1500 mm
Monteringsskruer	4x25 mm

2.2 El-forbindelse



ADVARSEL!

Risiko for brand og elektrisk stød.

- Alle elektriske tilslutninger skal udføres af en kvalificeret elektriker.
- Apparatet skal tilsluttes strøm m/jord, jvf. Stærkstrømsreglementet.
- Sørg for, at parametrene på typeskiltet er kompatible med nettilslutningens elektriske mærkeværdier.
- Brug altid en korrekt monteret lovlig stikkontakt.
- Brug ikke multistikadaptere og forlængerledninger.
- Pas på, du ikke beskadiger netstikket og netledningen. Hvis der bliver behov for at udskifte netledningen, skal det udføres af vores autoriserede servicecenter.
- Elledninger må ikke komme i berøring med eller nær ved apparatets låge, især når det er tændt, eller lågen er varm.
- Beskyttelsen mod elektrisk stød fra strømførende og isolerede dele skal fastgøres, så den ikke kan fjernes uden værktøj.
- Sæt først netstikket i stikkontakten ved installationens afslutning. Sørg for, at der er adgang til elstikket efter installationen.
- Hvis stikkontakten er løs, må du ikke sætte netstikket i.
- Undgå at slukke for apparatet ved at trække i netledningen. Tag altid selve netstikket ud af kontakten.
- Brug kun korrekte isoleringsenheder: Gruppeafbrydere, sikringer (sikringer med skruegevind skal tages ud af fatningen), fejlstrømsrelæer og kontaktorer.
- Apparatets installation skal udføres med et isolationsudstyr, så forbindelsen til lysnettet kan afbrydes på alle poler. Isolationsudstyret skal have en brydeafstand på mindst 3 mm.
- Luk apparatets luge helt, inden du sætter netstikket i stikkontakten.
- Dette apparat er forsynet med et stik og en strømledning.

2.3 Brug



ADVARSEL!

Risiko for personskade, forbrændinger og elektrisk stød eller eksplosion.

- Apparatets specifikationer må ikke ændres.
- Sørg for, at ventilationsåbningerne ikke er blokerede.
- Lad ikke apparatet være uden opsyn under drift.
- Sluk for apparatet efter hver brug.
- Vær forsigtig, når du åbner apparatets låge, hvis apparatet er i brug. Der kan slippe varm luft ud.
- Betjen ikke apparatet med våde hænder, eller når det har kontakt med vand.
- Tryk ikke på den åbne låge.
- Brug ikke apparatet som arbejds- eller frasætningsplads.
- Åbn apparatets låge forsigtigt. Brug af ingredienser med alkohol kan forårsage en blanding af alkohol og luft.
- Lad ikke gnister eller åben ild komme i kontakt med apparatet, når du åbner lågen.
- Læg ikke brændbare produkter eller genstande, der er våde med brændbare produkter i nærheden af eller på apparatet.
- Del ikke din Wi-Fi-adgangskode.



ADVARSEL!

Risiko for beskadigelse af apparatet.

- Sådan undgås skader eller misfarvning af emaljen:
 - Stil ikke ovnfaste fade eller andre genstande direkte i apparatet.
 - Læg ikke aluminiumsfolie direkte på bunden af ovnrummet.
 - Hæld ikke vand direkte ind i det varme apparat.
 - Hold ikke fugtige fade og madvarer i apparatet, når du har afsluttet tilberedningen.
 - Vær forsigtig, når du fjerner eller monterer tilbehøret.
- Farveændring af emaljen eller rustfrit stål forringer ikke apparatets ydeevne.
- Brug en bradepande til fugtige kager. Frugtsaft forårsager pletter, der kan være permanente.
- Tilbered altid mad med lågen lukket.
- Hvis apparatet installeres bag et møbelpanel (f.eks. en dør), skal du sørge for, at døren aldrig lukkes, mens apparatet er tændt. Der kan opbygges varme og fugt bag et lukket møbelpanel, hvilket kan forårsage efterfølgende skade på apparatet, huset eller gulvet. Luk ikke møbelpanelet, før apparatet er kølet helt af efter brug.

2.4 Vedligeholdelse og rengøring



ADVARSEL!

Risiko for personskade, brand eller skade på apparatet.

- Sluk for apparatet, og tag stikket ud af kontakten inden vedligeholdelse.
- Kontrollér, at apparatet er kølet af. Der er risiko for, at ovnglasset går i stykker.
- Udskift øjeblikkeligt ovnglassets paneler, hvis de er beskadigede. Kontakt det autoriserede servicecenter.
- Vær forsigtig, når du tager lågen af apparatet. Døren er tung!
- Rengør jævnlige apparatet for at forhindre forringelse af overfladematerialet.
- Rengør apparatet med en fugtig, blød klud. Brug kun neutrale rengøringsmidler. Brug ikke slibende midler, skuresvampe, opløsningsmidler eller metalgenstande.
- Hvis du bruger en ovnspray, skal du følge instruktionerne på dens emballage.

2.5 Pyrolyserengøring



ADVARSEL!

Risiko for personskade / brand / kemiske emissioner (dampe) i pyrolyse-tilstand.

- Inden pyrolytisk rensning og forvarmning skal følgende fjernes fra ovnrummet:
 - Alle madrester, spildt olie og fedt
 - alle udtagelige genstande (herunder hylder, ovnribber osv., der følger med apparatet), især alle non-stick gryder, pander, plader, redskaber osv.
- Læs omhyggeligt alle anvisninger vedrørende pyrolyserengøring.
- Hold børn væk fra apparatet, mens pyrolyserengøringen er i gang. Ovnens bliver meget varm, og varm luft afgives fra de forreste køleåbninger.
- Pyrolyserengøring er en proces ved høj temperatur, som kan frigive dampe fra madrester og konstruktionsmaterialet. Derfor rådes forbrugerne på det kraftigste til at:
 - Sørg for god udluftning under og efter pyrolyserengøringen.
 - giv god ventilation under og efter den første forvarmning.
- Undgå at spilde eller komme vand på ovnlågen under og efter den pyrolyserengøringen for at undgå at beskadige ovnglassene.

- Dampe fra alle pyrolytiske ovne / madrester som beskrevet er ikke skadelige for mennesker, herunder børn, eller personer med helbredsproblemer.
- Hold kæledyr væk fra apparatet under og efter pyrolyserengøringen og forvarmningen. Små kæledyr (især fugle og krybdyr) kan være meget følsomme over for temperaturændringer og udsendt røg.
- Non-stick-overflader på gryder, pander, bakker, redskaber osv. kan blive beskadiget af pyrolyserengøring ved høj temperatur i pyrolytiske ovne og kan også udgøre en kilde til skadelige dampe på lavt niveau.

2.6 Indvendig belysning



ADVARSEL!

Risiko for elektrisk stød.

- Vedrørende lampe(rne) i dette produkt og reservedelslamper, der sælges separat: Disse lamper er beregnet til at modstå ekstreme fysiske forhold i husholdningsapparater, såsom temperatur, vibration, fugt, eller er beregnet til at signalere information om apparatets driftsstatus. De er ikke beregnet til at blive brugt i andre apparater, og de er ikke velegnede til belysning af rum.
- Dette produkt indeholder en lyskilde i energieffektivitetsklasse G.
- Brug kun lamper med de samme specifikationer.

2.7 Service

- Kontakt det autoriserede servicecenter for at få repareret apparatet.
- Brug kun originale reservedele.

2.8 Bortskaffelse



ADVARSEL!

Risiko for personskade eller kvælning.

- Kontakt din genbrugsplads ang. oplysninger om, hvordan produktet bortskaffes korrekt.
- Tag stikket ud af kontakten.
- Klip netledningen af tæt ved apparatet og bortskaf den.
- Fjern lågelåsen for at forhindre, at børn eller kæledyr bliver fanget i apparatet.

3. PRODUKTBEKRIVELSE

3.1 Generelt overblik

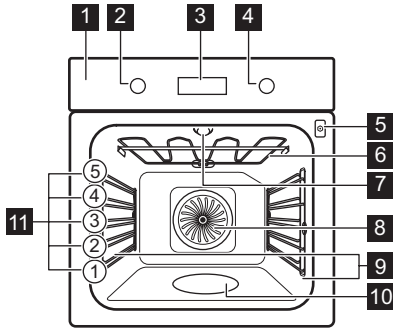

- 1 Betjeningspanel
- 2 Knap til ovnfunktioner
- 3 Display
- 4 Betjeningsknap
- 5 Stik til termometer
- 6 Varmelegeme
- 7 Ovnpære
- 8 Blæser
- 9 Ovnribbe, udtagelig
- 10 Ovnrumsprægning
- 11 Ovnriller

3.2 Tilbehør

Grillrist

Til kogegrej, kageforme, stege.

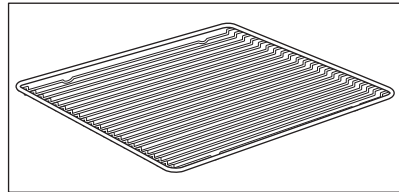

Bageplade

Til kager og småkager.

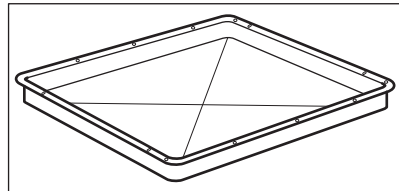

Grill-/bradepande

Til at bage og stege eller som en pande til opsamling af fedt.

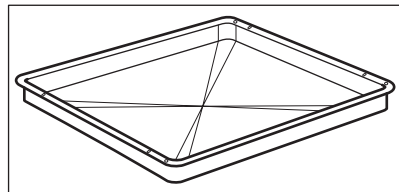

Professionelle plader

Til boller, kringler og småkager. Velegnet til dampfunktioner. Misfarvning af overfladen har ingen indvirkning på funktionerne.

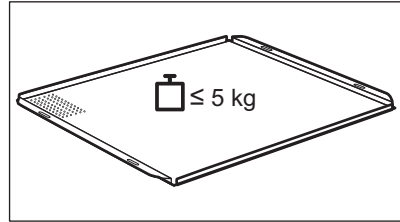

Termometer

Til måling af temperaturen i maden.

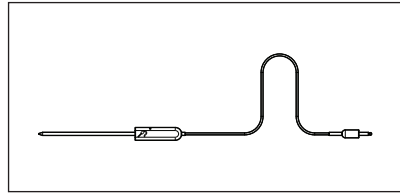







4. BETJENINGSPANEL

4.1 Forsænkbare knapper

Tryk på funktionsvælgeren for at bruge apparatet. Funktionsvælgeren kommer ud.

4.2 Oversigt over betjeningspanel







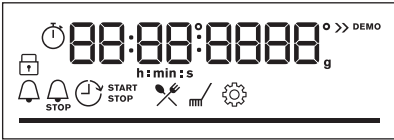







				OK		
Timer	Hurtig opvarmning	Lys	Termometer	Bekræft indstilling	Tryk	Drej knappen
Vælg en ovnfunktion for at tænde apparatet.						
Drej knappen for ovnfunktionerne til sluk-positionen for at slukke for apparatet.						

FØR BRUG FØRSTE GANG

4.3 Skærm

	Display med vigtige funktioner.
---	---------------------------------





Displaylamper

Grundlæggende indikatorer				
 Lås	 Hjælp til tilberedning	 Rengøring	 Indstillinger	 Hurtig opvarmning
Timerlamper				
 Minutur	 Sluttid	 Udskudt tid	 Optimer	
 Wi-Fi forbindelsen er slået til.		 Fjernbetjent tilstand er tændt.		
Wi-Fi indikator - blinker, når apparatet kan tilsluttes Wi-Fi.		Fjernbetjent tilstand indikator - apparatet kan fjernbetjenes.		
Statuslinje - til temperatur eller tid. Bjælken er helt rød, når apparatet når den indstillede temperatur.				
Indikator for damptilberedning				
Termometer Indikator				





5. FØR BRUG FØRSTE GANG

	ADVARSEL! Se kapitlerne om sikkerhed.
--	---

5.1 Indledende rengøring

Inden første ibrugtagning rengøres den tomme ovn, og tiden indstilles:			
			 00:00 Indstil tid. Tryk på: OK

5.2 Indledende forvarmning

 Forvarm den tomme ovn, inden du tager den i brug.	
Trin 1	Fjern al tilbehøret og de udtagelige ovnribber fra ovnen.
Trin 2	Indstil den maksimale temperatur for funktionen:  Lad ovnen være tændt i 1 time.
Trin 3	Indstil den maksimale temperatur for funktionen:  Lad ovnen være tændt i 15 min.
 Ovnen kan udsende lugt og røg under forvarmning. Kontroller, at rummet er udluftet.	

5.3 Trådløs forbindelse

For at tilslutte apparatet skal du bruge:

- Et trådløst netværk med internetforbindelsen.
- En mobilenhed, der er forbundet til det samme trådløse netværk.

Trin 1	Sådan downloades My Electrolux Kitchen app'en: Scan QR-koden på typeskiltet med kameraet på din mobilenhed for at blive omdirigeret til Electrolux' hjemmeside. Typeskiltet sidder på ovenns frontramme. Du kan også downloade appen direkte fra app store.
Trin 2	Følg instruktionerne i introduktionen til appen.
Trin 3	Drej knappen for ovnfunktioner for at vælge:  .
Trin 4	Drej betjeningsknappen for at vælge: Indstillinger. Tænd Wi-Fi. Se kapitlet "Menustruktur".

DAGLIG BRUG

Frekvens	2,4 Ghz WLAN
	2400 - 2483,5 Mhz
Protokol	IEEE 802.11b DSSS/802.11g/n OFDM
Maks. effekt	EIRP < 20 dBm (100 mW)
Wi-fi-modul	NIUS-50

5.4 Softwarelicenser

Softwaren i dette produkt indeholder komponenter, som er baseret på fri og open source-software. Electrolux anerkender bidragene fra de åbne software- og robotgrupper til udviklingsprojektet.

For at få adgang til kildekoden for disse gratis og åbne kildesoftwarekomponenter, hvis licensbetingelser kræver offentliggørelse, og for at se deres fulde oplysninger om copyright og gældende licensbetingelser, bedes du gå ind på: <http://electrolux.opensoftwarerepository.com> (mappe NIUS).

6. DAGLIG BRUG



ADVARSEL!

Se kapitlerne om sikkerhed.

6.1 Sådan indstilles: Ovnfunktioner

Trin 1	Drej knappen for ovnfunktionerne og vælg en ovnfunktion.
Trin 2	Drej kontrolknappen for at indstille temperaturen.
	- tryk og hold inde for at slå funktionen til: Hurtig opvarmning. Den er ikke tilgængelig for visse ovnfunktioner.

Tilberedning med damp

Sørg for, at ovnen er kold.

Trin 1	Trin 2	Trin 3	Trin 4
--------	--------	--------	--------





Tilberedning med damp







			Opvarm den tomme ovn i 10 minutter for at skabe fugt. Sæt mad i ovnen.
Fyld fordybningen i ovnrummet med vand.	Vælg dampovnfunktionen.	Indstil temperaturen.	
<p>i Der kan maks. være 250 ml i fordybningen i ovnrummet. Fyld ikke fordybningen i ovnrummets under tilberedning, eller når ovnen er meget varm.</p>			

Når tilberedningen med damp slutter:

Trin 1	Trin 2	Trin 3
Drej knappen for ovnfunktionerne til sluk-positionen for at slukke for ovnen.	Åbn forsigtigt lågen. Frigivet fugt kan forårsage forbrændinger.	Sørg for, at ovnen er kold. Fjern det resterende vand fra fordybningen i ovnrummet.

6.2 Ovnfunktioner

Ovnfunktion	Applikation
 Varmluft	Bagning på op til tre ovnriller samtidig og til tørring af fødevarer. Indstil temperaturen 20 - 40°C lavere end ved Over-/undervarme.
 Over-/undervarme	Til bagning og stegning af mad på én ovnrille.
 SteamBake	Til at tilføje fugtighed under madlavningen. Til at opnå den rette farve og sprøde skorpe under bagning. Til at give større saftighed under genopvarmning. Til henkogning af frugt og grøntsager.
 Pizza	Til at bage pizza. Til at lave en kraftig bruning og en sprød bund.

Ovnfunktion	Applikation
 <p>Undervarme</p>	Til bagning af kager med sprød bund og til henkogning.
 <p>Frosne madvarer</p>	Til tilberedning af sprøde færdigretter (f.eks. pommes frites, kartoffelbåde eller forårsruller).
 <p>Fugtig varmluft</p>	Denne funktion er beregnet til at spare energi under madlavning. Når du bruger denne funktion, kan temperaturen i ovnrummet variere fra den indstillede temperatur. Restvarmen anvendes. Varmeeffekten kan blive reduceret. Få flere oplysninger i kapitlet "Daglig brug", Bemærkninger til: Fugtig varmluft.
 <p>Grillstegning</p>	Til grillstegning af tynde stykker mad og til ristning af brød.
 <p>Turbogrill</p>	Til stegning af større stykker kød eller fjerkræ med ben på én hyldeposition. For at lave gratiner og til at brune.
 <p>Menu</p>	For at åbne menuen: Hjælp til tilberedning, Rengøring, Indstillinger.



Varmluft, Over-/undervarme: Når du indstiller temperaturen til under 80 °C, slukkes lampen automatisk efter 30 sekunder.

6.3 Bemærkninger til: Fugtig varmluft

Denne funktion blev anvendt til at overholde kravene i energieffektivitetsklasse og økodesign (i overensstemmelse med EU 65/2014 og EU 66/2014). Tests i overensstemmelse med: IEC/EN 60350-1

Ovnlågen skal være lukket under tilberedningen, så funktionen ikke afbrydes, og ovnen kører med den højeste energieffektivitet, der er mulig.

Når du bruger denne funktion, slukkes lampen automatisk efter 30 sekunder.

Se kapitlet "Råd" for at få oplysninger om tilberedning, Fugtig varmluft. Se kapitlet "Energieffektivitet", Energibesparelse for generelle anbefalinger til energibesparelse.

6.4 Sådan indstilles: Hjælp til tilberedning

Hver ret i denne undermenu har en anbefalet ovnfunktion og temperatur. Brug funktionen til at tilberede en ret hurtigt med standardindstillinger. Du kan justere tiden og temperaturen under tilberedningen.

Til nogle retter kan du også tilberede med:	Den grad, en ret tilberedes ved:
<ul style="list-style-type: none"> • Termometer 	<ul style="list-style-type: none"> • Rød • Medium • Gennemstegt













Trin 1	Trin 2	Trin 3	Trin 4
Åbn menuen.	Vælg Hjælp til tilberedning. Tryk på OK.	Vælg retten. Tryk på: OK	Sæt retten i ovnen. Bekræft indstillingen.





















6.5 Hjælp til tilberedning

















Forklaring	
	Termometer tilgængelig. Anbring Termometer i den tykkeste del af retten. Ovnen slukkes, når den indstillede Termometer temperatur er nået.
	Mængden af vand til dampfunktionen.
	Forvarm apparatet, før du begynder tilberedningen.
	Ribbe.















Displayet viser **P** og et **nummer** på retten, som du kan kontrollere i tabellen. Når funktionen slutter, skal du kontrollere, om maden er klar.

	Ret	Vægt	Ribbe/Tilbehør
1	Roastbeef, rød	1 - 1.5 kg; 4-5 cm tykke stykker	2; bageplade Steg kødet i nogle få minutter på en varm pande. Sæt i apparatet.
2	Roastbeef, rosa i midten		
3	Roastbeef, gennemstegt		

	Ret	Vægt	Ribbe/Tilbehør
4	Steak, medium	180 - 220 g pr. stykke, 3 cm tykke skiver	  3; stegefad på grillrist Steg kødet i nogle få minutter på en varm pande. Sæt i apparatet.
5	Oksessteg / braiseret (højreb, øverste rund, tyk flanksteak)	1.5 - 2 kg	  2; stegefad på grillrist Steg kødet i nogle få minutter på en varm pande. Tilsæt væske. Sæt i apparatet.
6	Roastbeef, rød (lavtemperaturstegning)	1 - 1.5 kg; 4-5 cm tykke stykker	  2; bageplade Brug dine yndlingskrydderier eller blot salt og friskkværnet peber. Steg kødet i nogle få minutter på en varm pande. Sæt i apparatet.
7	Roastbeef, medium (lavtemperaturstegning)		
8	Roastbeef, gennemstegt (lavtemperaturstegning)		
9	Filet, rød (lavtemperaturstegning)	0,5 - 1,5 kg; 5 - 6 cm tykke stykker	  2; bageplade Brug dine yndlingskrydderier eller blot salt og friskkværnet peber. Steg kødet i nogle få minutter på en varm pande. Sæt i apparatet.
10	Filet, medium (lavtemperaturstegning)		
11	Filet, færdig (lavtemperaturstegning)		
12	Kalvesteg (f.eks. bov)	0.8 - 1.5 kg; 4 cm tykke stykker	  2; stegefad på grillrist Brug dine yndlingskrydderier. Tilsæt væske. Tildækket steg.
13	Nakkesteg i nakkesteg	1.5 - 2 kg	 2; stegefad på grillrist Vend kødet efter halvdelen af tilberedningstiden.
14	Pulled pork (lavtemperaturstegning)	1.5 - 2 kg	  2; bageplade Brug dine yndlingskrydderier. Vend kødet efter halvdelen af tilberedningstiden for at få en ensartet bruning.





	Ret	Vægt	Ribbe/Tilbehør
15	Mørbrad, frisk	1 - 1.5 kg; 5-6 cm tykke stykker	  2; stegefad på grillrist Brug dine yndlingskrydderier.
16	Spareribs	2 - 3 kg; brug rå, 2-3 cm tynde spareribs	 3; bradepande Tilsæt væske for at dække bunden af retten. Vend kødet efter halvdelen af tilberedningstiden.
17	Lammeben med ben	1.5 - 2 kg; 7-9 cm tykke stykker	  2; stegefad på bageplade Tilsæt væske. Vend kødet efter halvdelen af tilberedningstiden.
18	Hel kylling	1 - 1.5 kg; frisk	  2;  200 ml; sammenkogt ret på bageplade Brug dine yndlingskrydderier. Vend kyllingen efter halvdelen af tilberedningstiden for at få en ensartet bruning.
19	Halv kylling	0.5 - 0.8 kg	  3; bageplade Brug dine yndlingskrydderier.
20	Kyllingebryst	180 - 200 g pr. stykke	  2;  2; sammenkogt ret på grillrist Brug dine yndlingskrydderier. Steg kødet i nogle få minutter på en varm pande.
21	Kyllingelår, fri-ske	-	  3; bageplade Hvis du marinerede kyllingelår først, skal du indstille den lavere temperatur og tilberede dem længere.
22	And, hel	2 - 3 kg	  2; stegefad på grillrist Brug dine yndlingskrydderier. Læg kødet på stegefadet. Vend anden efter halvdelen af tilberedningstiden.
23	Gås, hel	4 - 5 kg	  2; bradepande Brug dine yndlingskrydderier. Læg kødet på bradepanden. Vend gås efter halvdelen af tilberedningstiden.
24	Farsbrød	1 kg	  2; grillrist Brug dine yndlingskrydderier.

	Ret	Vægt	Ribbe/Tilbehør
25	Hel fisk, grillstegt	0.5 - 1 kgpr. fisk	  2; bageplade Fyld fisken med smør, og brug dine yndlingskrydderier og krydderurter.
26	Fiskefilet	-	  3; sammenkogt ret på grillrist Brug dine yndlingskrydderier.
27	Cheesecake	-	 2; ∅ 28 cm springform på grillrist
28	Æblekage	-	 2; 🍷 100 - 150 ml; bageplade
29	Æbletærte	-	 2; tærteform på grillrist
30	Æbletærte	-	 2; 🍷 100 - 150 ml;  22 cm tærteform på grillrist
31	Brownies	2 kg af dej	 3; bradepande
32	Chokolademuffins	-	 2; 🍷 100 - 150 ml; muffinbakke på grillrist
33	Brødkage	-	 2; brødplade på grillrist
34	Bagte kartofler	1 kg	 2; bageplade Læg de hele kartofler med skindet på bagepladen.
35	Kartoffelbåde	1 kg	 3; bageplade foret med bagepapir Brug dine yndlingskrydderier. Skær kartoflerne i stykker.
36	Grillede blandede grøntsager	1 - 1.5 kg	 3; bageplade foret med bagepapir Brug dine yndlingskrydderier. Skær grøntsagerne i stykker.
37	Kroketter, frosne	0.5 kg	 3; bageplade
38	Pommes frites, frosne	0.75 kg	 3; bageplade



	Ret	Vægt	Ribbe/Tilbehør
39	Kød / grøntsags-lamel med tørre nudeltallerkener	1 - 1.5 kg	 2 ; sammenkogt ret på grillrist
40	Kartoffelgratin (rå kartofler)	1 - 1.5 kg	 1 ; sammenkogt ret på grillrist Vend retten efter halvdelen af tilberedningstiden.
41	Pizza frisk, tynd	-	  2 ;  100 ml; bageplade foret med bagepapir
42	Pizza frisk, tyk	-	  2 ; bageplade foret med bagepapir
43	Quiche	-	 2 ; bageform på grillrist
44	Flute/ciabatta/ hvidt brød	0.8 kg	  2 ;  150 ml; bageplade foret med bagepapir Mere tid til hvidt brød.
45	Fuldkornsbrød/ rugbrød i brødform	1 kg	  2 ;  150 ml; bageplade foret med bagepapir / grillrist







7. URFUNKTIONER







7.1 Urfunktioner











Urfunktioner	Applikation
 Minutur	Når timeren har talt ned, høres signalet.
 STOP Tilberedningstid	Når timeren har talt ned, høres signalet, og ovnfunktionen stopper.
 Udskudt tid	For at udskyde starten og/eller tilberedningens afslutning.
 Optimer	Maksimum er 23 t 59 min. Denne funktion har ikke indflydelse på ovnen. For at tænde og slukke Optimer vælg: Menu, Indstillinger.

7.2 Sådan indstilles: Urfunktioner

Indstil: Aktuel tid		
Trin 1	Trin 2	Trin 3
		
For at ændre klokkeslættet skal du gå ind i menuen og vælge Indstillinger, Aktuel tid.	Indstil uret.	Tryk: OK.

Indstil: Minutur			
Trin 1	Displayet viser: 0:00 	Trin 2	Trin 3
			
Tryk på: 		Indstil Minutur	Tryk: OK.
 Timeren begynder straks at tælle ned.			

Indstil: Tilberedningstid				
Trin 1	Trin 2	Displayet viser: 0:00  STOP	Trin 3	Trin 4
				
Vælg en ovnfunktion og indstil temperaturen.	Tryk gentagne gange: 		Indstil tilberedningstiden.	Tryk: OK.
 Timeren begynder straks at tælle ned.				

Indstil: Udskudt tid							
Trin 1	Trin 2		Trin 3	Trin 4		Trin 5	Trin 6
		Display- et viser: aktuel tid  START			Display- et viser: ---  STOP		
Vælg ovn- funkti- on.	Tryk gen- tagne gange: 		Indstil startti- den.	Tryk: OK.		Indstil sluttiden.	Tryk: OK.
 Timeren begynder at tælle ned ved en indstillet starttid.							

8. BRUG AF TILBEHØRET



ADVARSEL!

Se kapitlerne om sikkerhed.

8.1 Isætning af tilbehør

En lille fordybning i toppen øger sikkerheden. Fordybningerne er også antivippe-anordninger. Den høje kant rundt om hylden forhindrer kogegrej i at glide af hylden.

Grillrist:

Skub risten mellem ovnribbens skinner, .

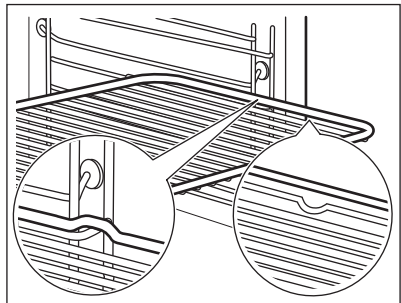

Bageplade / Dyb bradepande:

Skub den dybe bradepande ind mellem ovnribsens skinner.

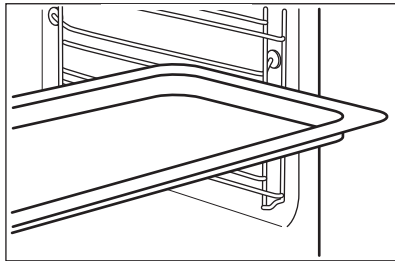

8.2 Termometer

Termometer - måler temperaturen i maden.

Der skal indstilles to temperaturer:

°C
Ovntemperaturen.

Kernetemperaturen.

For de bedste madlavningsresultater:

Ingredienserne bør være ved stuetemperatur.



Brug den ikke til flydende retter.

Under tilberedning skal det forblive i retten.

Anvendelse: Termometer

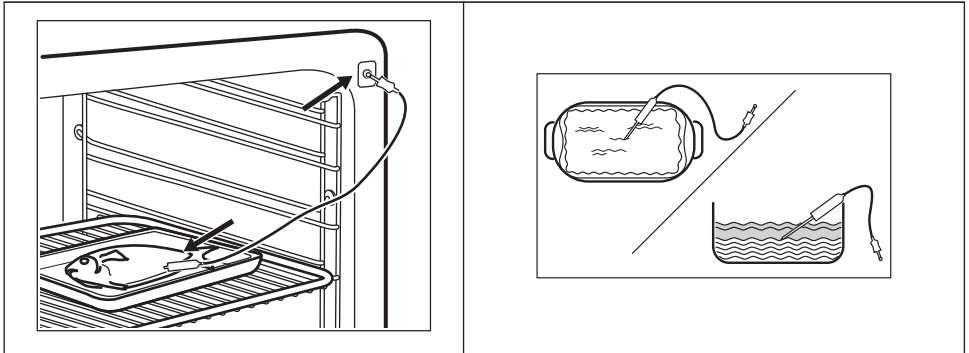





Trin 1	Tænd for ovnen.
Trin 2	Vælg en ovnfunktion og evt. ovntemperatur.
Trin 3	Indsæt: Termometer.
Kød, fjerkræ og fisk	Sammenkogte retter
Indsæt spidsen af Termometer i midten af kød, fisk, om muligt i den tykkeste del. Sørg for, at mindst 3/4 af Termometer er inde i retten.	Indsæt spidsen af Termometer nøjagtigt i midten af den sammenkogte ret. Termometer bør stabiliseres ét sted under bagning. Brug en fast ingrediens til at opnå dette. Brug kanten af bagepladen til at understøtte silikonehåndtaget på Termometer. Spidsen af Termometer bør ikke røre bunden af en bageform.



Trin 4	Stik Termometer i stikket på ovns forsiden. Displayet viser den aktuelle temperatur af: Termometer.
Trin 5	 - tryk for at indstille termometerets kerntemperatur.
Trin 6	OK - tryk for at bekræfte. Når maden når den indstillede temperatur, udsendes et signal. Du kan vælge at stoppe eller fortsætte tilberedningen for at sikre, at maden er gennemstegt.
Trin 7	Tag Termometer-stikket ud af stikket, og tag retten ud af ovnen. <div style="border: 1px solid black; padding: 5px; margin-top: 10px;">  ADVARSEL! Der er risiko for forbrændinger, da Termometer bliver varm. Pas på, når du trækker det ud og fjerner det fra maden. </div>



9. EKSTRAFUNKTIONER

9.1 Lås

Denne funktion forhindrer en utilsigtet ændring af ovnfunktionen.		
Tænd den, når ovnen virker - den indstillede tilberedning fortsætter, betjeningspanelet låses. Tænd den, når ovnen er slukket - den kan ikke tændes, betjeningspanelet er låst.		
 	 OK - tryk og hold inde for at slå funktionen til. Der lyder et signal.	 OK - tryk og hold inde for at slukke.
 3 x  - blinker, når låsen er slået til.		

9.2 Automatisk slukning

Af sikkerhedsgrunde slukkes ovnen efter nogen tid, hvis en ovnfunktion er i gang, og du ikke ændrer nogen af indstillingerne.

 (°C)	 (t)
30 - 115	12.5
120 - 195	8.5
200 - 245	5.5
250 - maksimum	3

Den automatiske slukning virker ikke med funktionerne: Lys, Termometer, Udskudt tid.

9.3 Køleblæser

Når ovnen er tændt, tændes køleblæseren automatisk for at holde ovnens overflader kølige. Hvis du slukker for ovnen, kan køleblæseren fortsætte med at køre, indtil ovnen køler ned.

9.4 Mekanisk lågelås

Lågelåsen er ulåst, når du køber ovnen.

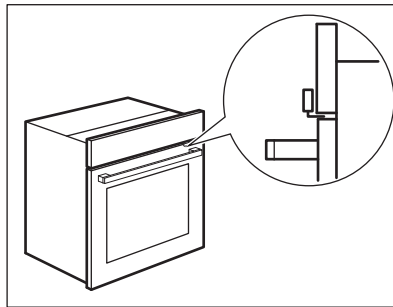

<p>⚠ FORSIGTIG! Bevæg ikke lågelåsen vertikalt. Tryk ikke på lågelåsen, når du lukker ovnlågen.</p>	
--	--

9.5 Anvendelse: Mekanisk lågelås

<p>Trin 1</p>	<p>Træk lågelåsen frem, indtil den låses, for at låse lågen.</p>
<p>Trin 2</p>	<p>For at låse op for lågen skal du trykke lågelåsen tilbage i panelet.</p>

Åbning af den låste låge

Du kan åbne lågen, når den mekaniske lågelås er låst.

<p>Trin 1</p>	<p>Tryk lågelåsen en smule, og åbn lågen ved at trække den med håndtaget.</p>
----------------------	---

Når du lukker lågen, skal du sørge for, at lågelåsen forbliver låst.

10. RÅD OG TIPS



10.1 Anbefalinger til tilberedning



Tabellernes temperaturer og tilberedningstider er kun vejledende. De afhænger af opskrifterne og kvaliteten og mængden af de anvendte ingredienser. Din ovn bager eller steger muligvis anderledes end den ovn, du havde før. Rådene herunder viser anbefalede indstillinger for temperatur, tilberedningstid og hyldeposition for specifikke typer mad. Hvis du ikke kan finde indstillinger til en speciel opskrift, kan du se efter en lignende.



10.2 Fugtig varmluft

For at få de bedste resultater skal du følge forslagene angivet på nedenstående tabel. Brug ovnens tredje ristposition.

	 (°C)	 (min.)
Pastagratin	200 - 220	45 - 55
Kartoffelgratin	180 - 200	70 - 85
Moussaka	170 - 190	70 - 95
Lasagne	180 - 200	75 - 90
Cannelloni	180 - 200	70 - 85
Brødbudding	190 - 200	55 - 70
Risbudding	170 - 190	45 - 60
Æblekage, lavet af rørt kagedej (rund form)	160 - 170	70 - 80
Franskbrød	190 - 200	55 - 70

10.3 Fugtig varmluft - anbefalet tilbehør

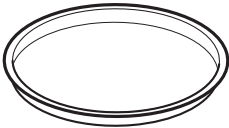
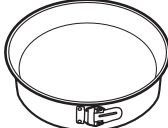



Brug mørke og ikke-reflekterende former og beholdere. De har en bedre varmeabsorbering end lyse og reflekterende ffade.

			
Pizzaform	Bageform	Ramekiner	Tærtbundform
Mørk, ikke-reflekterende 28 cm diameter	Mørk, ikke-reflekterende 26 cm diameter	Keramisk 8 cm diameter, 5 cm højde	Mørk, ikke-reflekterende 28 cm diameter

10.4 Madlavningstabeller for testinstitutter





Information til testinstitutter

Tests i overensstemmelse med: EN 60350, IEC 60350.
Bagning i ét lag - bagning i forme





		 °C	 min	
Fedtfattig sandkage	Varmluft	160	45 - 60	2
Fedtfattig sandkage	Over-/undervarme	160	45 - 60	2
Æbletærte, 2 forme Ø20 cm	Varmluft	160	55 - 65	2
Æbletærte, 2 forme Ø20 cm	Over-/undervarme	180	55 - 65	1
Smørkager	Varmluft	140	25 - 35	2
Smørkager	Over-/undervarme	140	25 - 35	2

Bagning i ét lag - lagkagebunde
Brug den tredje ovnrille.

VEDLIGEHOJDELSE OG RENGØRING

		 °C	 min
Små kager i form, 20 stk./plade, forvarm den tomme ovn	Varmluft	150	20 - 30
Små kager i form, 20 stk./plade, forvarm den tomme ovn	Over-/undervarme	170	20 - 30





Bagning i flere lag - lagkagebunde

		 °C	 min	
Smørkager	Varmluft	140	25 - 45	2 / 4
Små kager i form, 20 stk./plade, forvarm den tomme ovn	Varmluft	150	25 - 35	1 / 4
Fedtfattig sandkage	Varmluft	160	45 - 55	2 / 4
Æbletærte, 1 form pr. rist (Ø 20 cm)	Varmluft	160	55 - 65	2 / 4

Grill

Forvarm den tomme ovn i 5 minutter.

Grill med den maksimale temperaturindstilling.

		 min	
Toast	Grillstegning	1 - 2	5
Oksesteak, vendes undervejs	Grillstegning	24 - 30	4



11. VEDLIGEHOJDELSE OG RENGØRING



ADVARSEL!

Se kapitlerne om sikkerhed.

11.1 Bemærkninger om rengøring

 Rengøringsmidler	Rengør ovnens front med en mikrofiberklud med varmt vand og et mildt rengøringsmiddel.
	Brug en rengøringsmiddelopløsning til at rengøre metaloverflader.
	Rengør pletter med et mildt rengøringsmiddel.
 Hverdagsbrug	Rengør altid ovnrummet efter brug. Ophobning af fedt eller andre rester kan forårsage brand.
	Opbevar ikke madvarer i ovnen i mere end 20 minutter. Ovnrummet tørres kun med en mikrofiberklud efter hver brug.
 Tilbehør	Rengør alt tilbehør efter hver brug, og lad det tørre. Brug en mikrofiberklud med varmt vand og et mildt rengøringsmiddel. Tilbehøret må ikke vaskes i opvaskemaskinen.
	Rengør ikke non stick-tilbehøret med slibende rengøringsmiddel eller genstande med skarpe kanter.

11.2 Rengøring: Prægning i ovnrum

Rengør fordybningen i ovnrummet for at fjerne kalkrester efter tilberedning med damp.

Trin 1	Trin 2	Trin 3
Hæld: 250 ml hvid eddike ind i fordybningen i ovnrummet. Brug maks. 6% eddike uden tilsætningsstoffer.	Lad eddiken opløse kalkresterne ved stuetemperatur i 30 minutter.	Rengør ovnrummet med varmt vand og en blød klud.
For funktionen: SteamBake rengør ovnen, hver gang der er gået 5 - 10 tilberedningscyklusser.		

11.3 Fjernelse: Ovnribber

Fjern ovnribberne, så ovnen kan rengøres.

VEDLIGEHOJDELSE OG RENGØRING

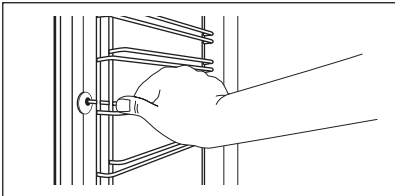
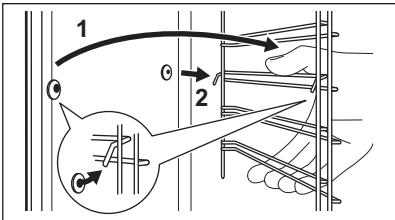
Trin 1	Sluk for ovnen, og vent, til den er kold.	
Trin 2	Træk forenden af ribben væk fra sidevæggen.	
Trin 3	Træk den bageste ende af ovnribben væk fra sidevæggen, og tag den ud.	
Trin 4	Montér ovnribberne i modsat rækkefølge.	

11.4 Anvendelse: Pyrolyserengøring

Rengør ovnen med Pyrolyserengøring.



ADVARSEL!

Der er risiko for forbrænding.



FORSIGTIG!



Hvis der er andre apparater installeret i det samme skab, bør de ikke bruges samtidigt med denne funktion. Det kan skade ovnen.

Før Pyrolyserengøring:

Sluk for ovnen, og vent, til den er kold.	Fjern al tilbehøret fra ovnen og de udtagelige ovnribber fra ovnen.	Rengør ovnbunden og det indvendige lågeglas med varmt vand, en blød klud og et mildt rengøringsmiddel.
---	---	--

Pyrolyserengøring

Trin 1	Åbn menuen: Rengøring $\frac{m}{l}$.	
	Valgmulighed	Varighed
	C1 - Let rengøring	1 h
	C2 - Normal rengøring	1 h 30 min

Pyrolyserengøring	
C3 - Grundig rengøring	3 h
Trin 2	OK - tryk for at vælge rengøringsprogrammet.
Trin 3	OK – tryk for at starte rengøringen.
Trin 4	Drej knappen for ovnfunktioner til slukket efter rengøring.
<p> Når rengøringen starter, låses ovnens låge, og lampen er slukket. Indtil lågen låses op, viser displayet: .</p>	



Når rengøringen slutter:		
Sluk for ovnen, og vent, til den er kold.	Rengør ovnrummet med en blød klud.	Fjern resterne fra bunden af ovnrummet.

11.5 Husk rengøring

Ovnen minder dig om, når du skal rengøre den med pyrolyserengøring.	
 blinker i displayet i 5 sek. efter hver tilberedning.	For at deaktivere påmindelsen skal du indtaste Menu og vælg Indstillinger, Husk rengøring.

11.6 Sådan fjerner og installerer du: Låge

Du kan tage lågen og det indvendige ovnglas ud for at rengøre det. Antallet af glaspaneler er forskelligt for forskellige modeller.

	ADVARSEL! Døren er tung.
	FORSIGTIG! Hånder forsigtigt glasset, især omkring frontpanelets kanter. Glasset kan gå i stykker.

VEDLIGEHOLDELSE OG RENGØRING

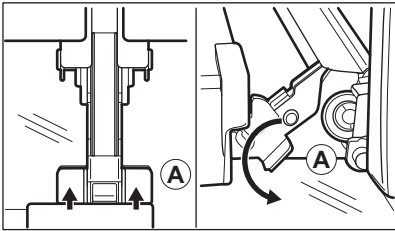
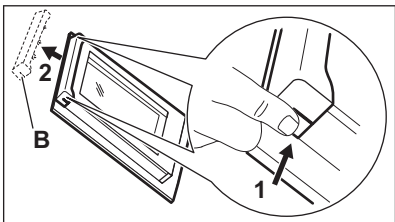
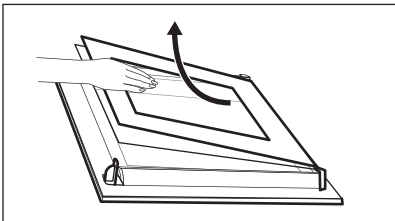
Trin 1	Åbn lågen helt.	
Trin 2	Løft og tryk låsegrebene (A) helt på de to lågehængsler.	
Trin 3	Sæt ovnlågen i den første tætte position (vinkel på ca. 70°). Hold lågen i begge sider, og træk den væk fra ovnen i en vinkel opad. Læg lågen med ydersiden nedad på en blød klud på et stabilt underlag.	
Trin 4	Hold i begge sider af lågelisten (B) i lågens overkant, og tryk indad, indtil låsehagen slipper.	
Trin 5	Træk lågelisten fremad, og tag den ud.	
Trin 6	Hold i overkanten af hvert enkelt ovnglas, og træk det opad og ud af skinnen.	
Trin 7	Rengør glaspanelet med vand og sæbe. Tør ovnglasset forsigtigt. Ovnglasset må ikke komme i opvaskemaskinen.	
Trin 8	Udfør ovennævnte trin i omvendt rækkefølge efter rengøring.	
Trin 9	Sæt det mindste glas i først og derefter det største og lågen. Sørg for, at glassene er sat i den rigtige position, da lågens overflade ellers kan blive overophedet.	

11.7 Udskiftning: Lampe



ADVARSEL!

Risiko for elektrisk stød
Pæren kan være varm.

Før du udskifter pæren:

Trin 1	Trin 2	Trin 3
Sluk for ovnen. Vent, til ovnen er kold.	Tag stikket ud af kontakten.	Læg en klud i bunden af ovnrummet.

Toplampe

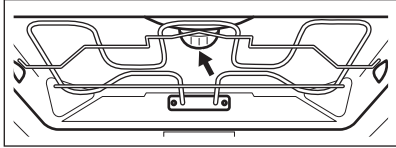
Trin 1	Drej glasset, og tag det af.	
Trin 2	Rengør glasdækslet.	
Trin 3	Udskift pæren med en passende 300 °C varmefast pære.	
Trin 4	Montér glasdækslet.	

Sidelampe

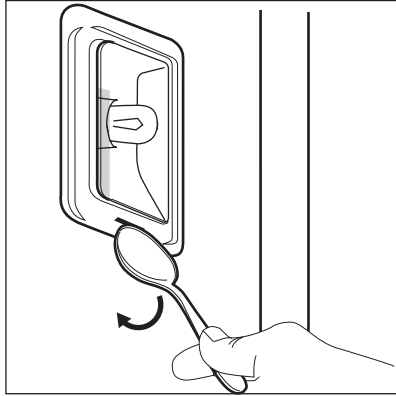
Trin 1	Fjern den venstre hyldestøtte for at få adgang til pæren.	
Trin 2	Brug en smal, stump genstand (f.eks. en teske) til at fjerne glasdækslet.	
Trin 3	Rengør glasdækslet.	
Trin 4	Udskift pæren med en passende 300 °C varmefast pære.	
Trin 5	Montér glasdækslet.	
Trin 6	Montér venstre hyldestøtte.	

12. FEJLFINDING





ADVARSEL!

Se kapitlerne om sikkerhed.

12.1 Hvad gør du, hvis ...

I eventuelle tilfælde, der ikke er inkluderet i denne tabel, bedes du kontakte et autoriseret servicecenter.

 Apparatet tænder ikke eller bliver ikke varmt	
Problemer	Kontrollér, om ...
du ikke kan tænde eller betjene apparatet.	apparatet er sluttet korrekt til en strømforsyning.
Apparatet bliver ikke varmt.	Den automatiske slukning er deaktiveret.
Apparatet bliver ikke varmt.	Apparatets låge er lukket.
Apparatet bliver ikke varmt.	Sikringen er ikke sprunget.
Apparatet bliver ikke varmt.	Låsen er slået fra.

 Komponenter	
Problem	Kontrollér, om ...
Lyset er slukket.	Fugtig varmluft - er tændt.
Pæren virker ikke.	Pæren er sprunget.
Termometer virker ikke.	Stikket fra Termometer er sat helt ind i stikkontakten.

 Fejlkoder	
Displayet viser...	Kontrollér, om ...
Err C2	Du tog Termometer stikket ud af stikkontakten.
Err C3	Ovnlågen er lukket, eller lågelåsen ikke er ødelagt.
Err F102	Apparatets låge er lukket.

**Fejlkoder**

Err F102	Lågelåsen er ikke ødelagt.
00:00	Der har været strømafbrydelse. Indstil aktuell tid.
Hvis displayet viser en fejlkode, der ikke findes i denne tabel, skal husets sikring slukkes og tændes for at genstarte apparatet. Kontakt et autoriseret servicecenter, hvis fejlkoden forekommer igen.	

**Rengøring**

Problem	Kontrollér, om ...
Vandet kommer ud af fordybningen i ovnrummet.	Der er for meget vand i fordybningen i ovnrummet.

12.2 Servicedata

Kontakt din forhandler eller et autoriseret servicecenter, hvis du ikke selv kan løse problemet. De nødvendige oplysninger til servicecenteret er angivet på maskinens typeskilt. Typeskiltet sidder på ovenns frontramme. Typeskiltet må ikke fjernes fra ovnrummet.

Det anbefales, at du noterer oplysningerne her:	
Model (MOD.)
Produktnummer (PNC)
Serienummer (S.N.)

13. ENERGIEFFEKTIV**13.1 Produktoplysninger og produktoplysningsark**

Leverandørens navn	Electrolux
--------------------	------------

Identifikation af model	COP827V 944032113 COP827X 944032112 EO82PBK 944032114	
Energieffektivitetsindeks	81.2	
Energieffektivitetsklasse	A+	
Energiforbrug med en standardmængde, almindelig tilstand	1.09 kWh/cyklus	
Energiforbrug med en standardmængde, blæsertvungen tilstand	0.69 kWh/cyklus	
Antal ovnrum	1	
Varmekilde	Elektricitet	
Lydstyrke	71 l	
Type ovn	Indbygningsovn	
Vægt	COP827V	35.0 kg
	COP827X	35.0 kg
	EO82PBK	35.0 kg

IEC/EN 60350-1 - Elektriske husholdningsapparater til madlavning - Del 1: Komfurer, ovne, dampovne og grillapparater - Metoder til måling af ydeevne.

13.2 Energibesparelse



Apparatet indeholder funktioner, som hjælper dig med at spare energi ved daglig madlavning.

Sørg for, at ovenns låge er lukket, når ovnen er tændt. Åbn ikke ovenlågen for ofte under tilberedningen. Hold dørpakningen ren og sørg for, at den sidder godt fast.

Brug køkkengrej af metal for at øge energibesparelsen.

Forvarm om muligt ikke ovnen inden tilberedning.

Hold pauserne mellem bagning så korte som muligt, når du tilbereder nogle få retter på én gang.

Tilberedning med blæser

Brug om muligt tilberedningsfunktionerne med blæser for at spare energi.

Restvarme

Blæseren og lampen bliver ved med at være tændt. Når du tænder for ovnen, viser displayet eftervarmen. Du kan bruge varmen til at holde maden varm.

Når tilberedningsvarigheden er længere end 30 min., skal du reducere ovntemperaturen til minimum 3 - 10 min. inden tilberedningen er slut. Eftervarmen i ovnen vil blive ved med at tilberede maden.

Brug restvarmen til at opvarme andre retter.

Hold maden varm

Vælg den lavest mulige temperaturindstilling for at bruge restvarme og holde et måltid varmt. Restvarmelampen eller temperaturen vises på displayet.

Tilberedning med slukket lampe

Sluk for lampen under tilberedning. Tænd kun for det, når det er nødvendigt.







Fugtig varmluft



Denne funktion er beregnet til at spare energi under madlavning.

Når du bruger denne funktion, slukkes lampen automatisk efter 30 sekunder. Du kan tænde det igen, men denne handling vil mindske den forventede energibesparelse.

14. MENUSTRUKTUR

14.1 Menu

Trin 1	Trin 2	Trin 3	Trin 4	Trin 5
				
 - vælg for at åbne Menu.	Vælg indstillingen fra Menu struktur, og tryk på OK.	Vælg indstillingen.	OK - tryk for at bekræfte indstilling.	Justér værdien, og tryk på OK.
Drej knappen for ovnfunktionerne til sluk-positionen for at forlade Menu.				



Menu struktur		
Hjælp til tilberedning 	Rengøring 	Indstillinger 

Indstillinger					
01	Aktuel tid	Skift	02	Lysstyrke display	1 - 5
03	Panelsignal	1 - Bip 2 - Klik 3 - Lyd fra	04	Signal volume	1 - 4

MENUSTRUKTUR

Indstillinger					
05	Termometer Handling	1 - Alarm og stop 2 - Alarm	06	Optimer	Tænd / sluk
07	Lys	Tænd / sluk	08	Hurtig opvarmning	Tænd / sluk
09	Husk rengøring	Tænd / sluk	10	Wi-Fi	Tænd / sluk
11	Automatisk fjernbetjening	Tænd / sluk	12	Glem netværk	Ja/nej
13	Demo funktion	Aktiveringskode: 2468	14	Softwareversion	Kontroller
15	Nulstil alle indstillinger	Ja/nej			

15. MILJØHENSYN

Genbrug materialer med symbolet . Anbring emballagematerialet i passende beholdere til genbrug. Hjælp med at beskytte miljøet og menneskelig sundhed samt at genbruge affald af elektriske og elektroniske apparater. Kasser ikke apparater, der er mærket med symbolet , sammen med husholdningsaffaldet. Lever produktet tilbage til din lokale genbrugsplads eller kontakt din kommune.

WELCOME TO ELECTROLUX! THANK YOU FOR CHOOSING OUR APPLIANCE.



In our drive to be sustainable, we are reducing paper assets and provide full user manuals online. Access your full user manual at electrolux.com/manuals



Get usage advice, brochures, trouble shooter, service and repair information at electrolux.com/support



For more recipes, hints, troubleshooting download **My Electrolux Kitchen** app.



CONTENTS

1. SAFETY INFORMATION.....	43	7. CLOCK FUNCTIONS.....	60
1.1 Children and vulnerable people safety.....	43	7.1 Clock functions.....	60
1.2 General Safety.....	43	7.2 How to set: Clock functions.....	60
2. SAFETY INSTRUCTIONS.....	45	8. USING THE ACCESSORIES.....	62
2.1 Installation.....	45	8.1 Inserting accessories.....	62
2.2 Electrical connection.....	46	8.2 Food Sensor.....	63
2.3 Use.....	46	9. ADDITIONAL FUNCTIONS.....	64
2.4 Care and cleaning.....	47	9.1 Lock.....	64
2.5 Pyrolytic cleaning.....	47	9.2 Automatic switch-off.....	65
2.6 Internal lighting.....	48	9.3 Cooling fan.....	65
2.7 Service.....	48	9.4 Mechanical door lock.....	65
2.8 Disposal.....	48	9.5 How to use: Mechanical door lock.....	66
3. PRODUCT DESCRIPTION.....	49	10. HINTS AND TIPS.....	67
3.1 General overview.....	49	10.1 Cooking recommendations.....	67
3.2 Accessories.....	49	10.2 Moist Fan Baking.....	67
4. CONTROL PANEL.....	50	10.3 Moist Fan Baking - recommended accessories.....	67
4.1 Retractable knobs.....	50	10.4 Cooking tables for test institutes.....	68
4.2 Control panel overview.....	50	11. CARE AND CLEANING.....	69
4.3 Display.....	50	11.1 Notes on cleaning.....	70
5. BEFORE FIRST USE.....	51	11.2 How to clean: Cavity embossment.....	70
5.1 Initial cleaning.....	51	11.3 How to remove: Shelf supports	70
5.2 Initial preheating.....	52	11.4 How to use: Pyrolytic Cleaning.....	71
5.3 Wireless connection 	52	11.5 Cleaning Reminder.....	72
5.4 Software licences.....	53	11.6 How to remove and install: Door.....	72
6. DAILY USE.....	53	11.7 How to replace: Lamp.....	73
6.1 How to set: Heating functions.....	53	12. TROUBLESHOOTING.....	74
6.2 Heating functions.....	54	12.1 What to do if.....	75
6.3 Notes on: Moist Fan Baking.....	55	12.2 Service data.....	76
6.4 How to set: Assisted Cooking.....	55		
6.5 Assisted Cooking.....	56		

CONTENTS

13. ENERGY EFFICIENCY	76	14. MENU STRUCTURE	78
13.1 Product Information and Product Information Sheet.....	76	14.1 Menu.....	78
13.2 Energy saving.....	77	15. ENVIRONMENTAL CONCERNS	79

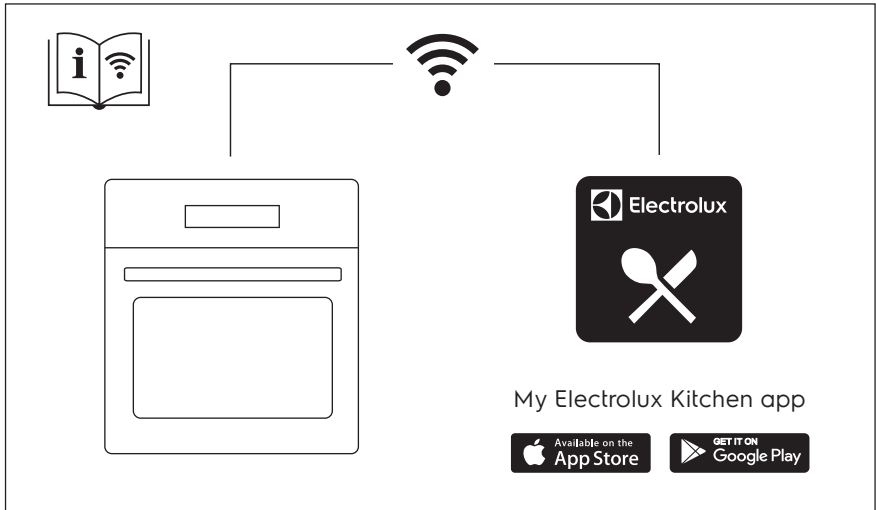

Subject to change without notice.

1. ⚠ SAFETY INFORMATION

Before the installation and use of the appliance, carefully read the supplied instructions. The manufacturer is not responsible for any injuries or damage that are the result of incorrect installation or usage. Always keep the instructions in a safe and accessible location for future reference.

1.1 Children and vulnerable people safety

- This appliance can be used by children aged from 8 years and above and persons with reduced physical, sensory or mental capabilities or lack of experience and knowledge if they have been given supervision or instruction concerning the use of the appliance in a safe way and understand the hazards involved. Children of less than 8 years of age and persons with very extensive and complex disabilities shall be kept away from the appliance unless continuously supervised.
- Children should be supervised to ensure that they do not play with the appliance and mobile devices with My Electrolux Kitchen .
- Keep all packaging away from children and dispose of it appropriately.
- **WARNING:** The appliance and its accessible parts become hot during use. Keep children and pets away from the appliance when in use and when cooling down.
- If the appliance has a child safety device, it should be activated.
- Children shall not carry out cleaning and user maintenance of the appliance without supervision.

1.2 General Safety

- This appliance is for cooking purposes only.
- This appliance is designed for single household domestic use in an indoor environment.

SAFETY INFORMATION

- This appliance may be used in, offices, hotel guest rooms, bed & breakfast guest rooms, farm guest houses and other similar accommodation where such use does not exceed (average) domestic usage levels.
- Only a qualified person must install this appliance and replace the cable.
- Do not use the appliance before installing it in the built-in structure.
- Disconnect the appliance from the power supply before carrying out any maintenance.
- If the mains power supply cable is damaged, it must be replaced by the manufacturer, its Authorised Service Centre or similarly qualified persons to avoid an electrical hazard.
- **WARNING:** Ensure that the appliance is switched off before replacing the lamp to avoid the possibility of electric shock.
- **WARNING:** The appliance and its accessible parts become hot during use. Care should be taken to avoid touching heating elements or the surface of the appliance cavity.
- Always use oven gloves to remove or insert accessories or ovenware.
- Use only the food sensor (core temperature sensor) recommended for this appliance.
- To remove the shelf supports first pull the front of the shelf support and then the rear end away from the side walls. Install the shelf supports in the opposite sequence.
- Do not use a steam cleaner to clean the appliance.
- Do not use harsh abrasive cleaners or sharp metal scrapers to clean the glass door since they can scratch the surface, which may result in shattering of the glass.
- Before pyrolytic cleaning, remove all accessories and excessive deposits/spills from the appliance cavity.

2. SAFETY INSTRUCTIONS

2.1 Installation

WARNING!

Only a qualified person must install this appliance.

- Remove all the packaging.
- Do not install or use a damaged appliance.
- Follow the installation instructions supplied with the appliance.
- Always take care when moving the appliance as it is heavy. Always use safety gloves and enclosed footwear.
- Do not pull the appliance by the handle.
- Install the appliance in a safe and suitable place that meets installation requirements.
- Keep the minimum distance from other appliances and units.
- Before mounting the appliance, check if the appliance door opens without restraint.
- The appliance is equipped with an electric cooling system. It must be operated with the electric power supply.
- The built-in unit must meet the stability requirements of DIN 68930.

Cabinet minimum height (Cabinet under the work-top minimum height)	578 (600) mm
Cabinet width	560 mm
Cabinet depth	550 (550) mm
Height of the front of the appliance	594 mm
Height of the back of the appliance	576 mm
Width of the front of the appliance	595 mm
Width of the back of the appliance	559 mm
Depth of the appliance	567 mm
Built in depth of the appliance	546 mm
Depth with open door	1027 mm
Ventilation opening minimum size. Opening placed on the bottom rear side	560x20 mm
Mains supply cable length. Cable is placed in the right corner of the back side	1500 mm
Mounting screws	4x25 mm

SAFETY INSTRUCTIONS

2.2 Electrical connection



WARNING!

Risk of fire and electric shock.

- All electrical connections should be made by a qualified electrician.
- The appliance must be earthed.
- Make sure that the parameters on the rating plate are compatible with the electrical ratings of the mains power supply.
- Always use a correctly installed shockproof socket.
- Do not use multi-plug adapters and extension cables.
- Make sure not to cause damage to the mains plug and to the mains cable. Should the mains cable need to be replaced, this must be carried out by our Authorised Service Centre.
- Do not let mains cables touch or come near the appliance door or the niche below the appliance, especially when it operates or the door is hot.
- The shock protection of live and insulated parts must be fastened in such a way that it cannot be removed without tools.
- Connect the mains plug to the mains socket only at the end of the installation. Make sure that there is access to the mains plug after the installation.
- If the mains socket is loose, do not connect the mains plug.
- Do not pull the mains cable to disconnect the appliance. Always pull the mains plug.
- Use only correct isolation devices: line protecting cut-outs, fuses (screw type fuses removed from the holder), earth leakage trips and contactors.
- The electrical installation must have an isolation device which lets you disconnect the appliance from the mains at all poles. The isolation device must have a contact opening width of minimum 3 mm.
- Fully close the appliance door before you connect the mains plug to the mains socket.
- This appliance is supplied with a main plug and a main cable.

2.3 Use



WARNING!

Risk of injury, burns and electric shock or explosion.

- Do not change the specification of this appliance.
- Make sure that the ventilation openings are not blocked.
- Do not let the appliance stay unattended during operation.
- Deactivate the appliance after each use.
- Be careful when you open the appliance door while the appliance is in operation. Hot air can release.
- Do not operate the appliance with wet hands or when it has contact with water.
- Do not apply pressure on the open door.
- Do not use the appliance as a work surface or as a storage surface.
- Open the appliance door carefully. The use of ingredients with alcohol can cause a mixture of alcohol and air.
- Do not let sparks or open flames to come in contact with the appliance when you open the door.
- Do not put flammable products or items that are wet with flammable products in, near or on the appliance.
- Do not share your Wi-Fi password.

**WARNING!**

Risk of damage to the appliance.

- To prevent damage or discoloration to the enamel:
 - do not put ovenware or other objects in the appliance directly on the bottom.
 - do not put aluminium foil directly on the bottom of cavity of the appliance.
 - do not put water directly into the hot appliance.
 - do not keep moist dishes and food in the appliance after you finish the cooking.
 - be careful when you remove or install the accessories.
- Discoloration of the enamel or stainless steel has no effect on the performance of the appliance.
- Use a deep pan for moist cakes. Fruit juices cause stains that can be permanent.
- Always cook with the appliance door closed.
- If the appliance is installed behind a furniture panel (e.g. a door) make sure the door is never closed when the appliance operates. Heat and moisture can build up behind a closed furniture panel and cause subsequent damage to the appliance, the housing unit or the floor. Do not close the furniture panel until the appliance has cooled down completely after use.

2.4 Care and cleaning

**WARNING!**

Risk of injury, fire, or damage to the appliance.

- Before maintenance, deactivate the appliance and disconnect the mains plug from the mains socket.
- Make sure the appliance is cold. There is the risk that the glass panels can break.
- Replace immediately the door glass panels when they are damaged. Contact the Authorised Service Centre.
- Be careful when you remove the door from the appliance. The door is heavy!
- Clean regularly the appliance to prevent the deterioration of the surface material.
- Clean the appliance with a moist soft cloth. Use only neutral detergents. Do not use abrasive products, abrasive cleaning pads, solvents or metal objects.
- If you use an oven spray, follow the safety instructions on its packaging.

2.5 Pyrolytic cleaning

**WARNING!**

Risk of Injury / Fires / Chemical Emissions (Fumes) in Pyrolytic Mode.

- Before carrying out the pyrolytic cleaning and initial preheating remove from the oven cavity:
 - any excess food residues, oil or grease spills / deposits.
 - any removable objects (including shelves, side rails, etc., provided with the appliance) especially any non-stick pots, pans, trays, utensils, etc.
- Read carefully all the instructions for pyrolytic cleaning.
- Keep children away from the appliance while the pyrolytic cleaning operates. The appliance becomes very hot and hot air is released from the front cooling vents.
- Pyrolytic cleaning is a high temperature operation that can release fumes from cooking residues and construction materials, as such consumers are advised to:
 - provide good ventilation during and after the pyrolytic cleaning.
 - provide good ventilation during and after the initial preheating.

SAFETY INSTRUCTIONS

- Do not spill or apply water on the oven door during and after the pyrolytic cleaning to avoid damaging the glass panels.
- Fumes released from all pyrolytic ovens / cooking residues as described are not harmful to humans, including children, or persons with medical conditions.
- Keep pets away from the appliance during and after the pyrolytic cleaning and initial preheating. Small pets (especially birds and reptiles) can be highly sensitive to temperature changes and emitted fumes.
- Non-stick surfaces on pots, pans, trays, utensils etc., can be damaged by the high temperature pyrolytic cleaning operation of all pyrolytic ovens and can be also a source for low level harmful fumes.

2.6 Internal lighting



WARNING!

Risk of electric shock.

- Concerning the lamp(s) inside this product and spare part lamps sold separately: These lamps are intended to withstand extreme physical conditions in household appliances, such as temperature, vibration, humidity, or are intended to signal information about the operational status of the appliance. They are not intended to be used in other applications and are not suitable for household room illumination.
- This product contains a light source of energy efficiency class G.
- Use only lamps with the same specifications.

2.7 Service

- To repair the appliance contact the Authorised Service Centre.
- Use original spare parts only.

2.8 Disposal



WARNING!

Risk of injury or suffocation.

- Contact your municipal authority for information on how to dispose of the appliance.
- Disconnect the appliance from the mains supply.
- Cut off the mains electrical cable close to the appliance and dispose of it.
- Remove the door catch to prevent children or pets from becoming trapped in the appliance.

3. PRODUCT DESCRIPTION

3.1 General overview

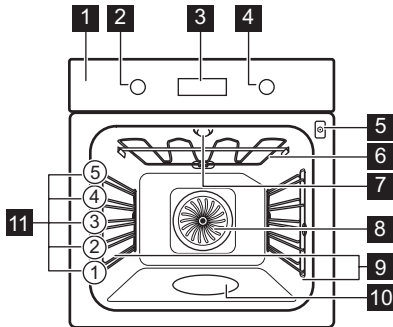

- 1** Control panel
- 2** Knob for the heating functions
- 3** Display
- 4** Control knob
- 5** Socket for the food sensor
- 6** Heating element
- 7** Lamp
- 8** Fan
- 9** Shelf support, removable
- 10** Cavity embossment
- 11** Shelf positions

3.2 Accessories

Wire shelf

For cookware, cake tins, roasts.

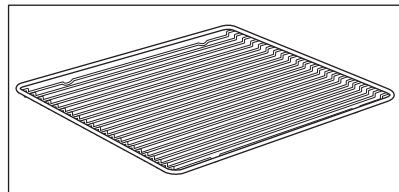

Baking tray

For cakes and biscuits.

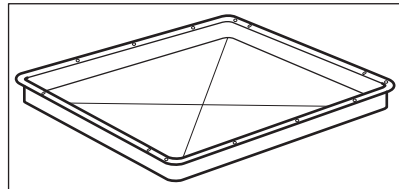

Grill- / Roasting pan

To bake and roast or as a pan to collect fat.

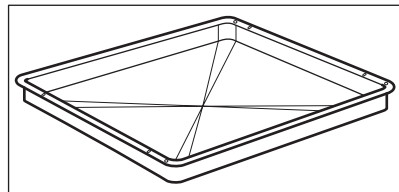

CONTROL PANEL

Patisserie tray

For rolls, pretzels and small pastries. Suitable for steam functions. The discolouration of the surface has no effect on the functions.

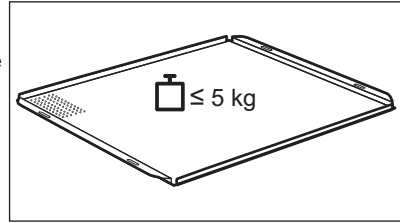

Food sensor

To measure the temperature inside food.

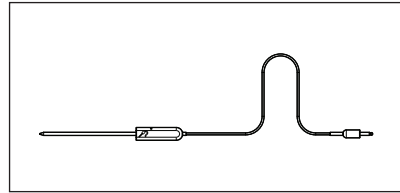







4. CONTROL PANEL

4.1 Retractable knobs

To use the appliance press the knob. The knob comes out.

4.2 Control panel overview















				OK		
Timer	Fast Heat Up	Light	Food Sensor	Confirm setting	Press	Turn the knob
Select a heating function to turn on the appliance.						
Turn the knob for the heating functions to the off position to turn the appliance off.						

4.3 Display

<p>The display shows a digital readout with the format "h:min:s" and "g". Above the numbers are icons for a timer, a bell, and a gear. Below the numbers are icons for a bell with "STOP", a clock with "START STOP", a fork and knife, and a milliliter symbol. The text "DEMO" is visible on the right side of the display.</p>	<p>Display with key functions.</p>
---	------------------------------------

BEFORE FIRST USE

Display indicators

Basic indicators				
 Lock	 Assisted Cooking	 Cleaning	 Settings	 Fast Heat Up
Timer indicators				
 Minute minder	 End time	 Time Delay	 Uptimer	
 Wi-Fi connection is turned on.		 Remote operation is turned on.		
Wi-Fi indicator - flashes when the appliance can be connected to Wi-Fi.		Remote operation indicator - the appliance can be controlled remotely.		
Progress bar - for temperature or time. The bar is fully red when the appliance reaches the set temperature.				
Steam cooking indicator				
Food sensor indicator				





5. BEFORE FIRST USE



WARNING!

Refer to Safety chapters.

5.1 Initial cleaning



Before the first use, clean the empty appliance and set the time:			
			 00:00 Set the time. Press OK.

BEFORE FIRST USE

5.2 Initial preheating



Preheat the empty oven before the first use.

Step 1	Remove all accessories and removable shelf supports from the oven.
Step 2	Set the maximum temperature for the function:  Let the oven operate for 1 h.
Step 3	Set the maximum temperature for the function:  Let the oven operate for 15 min.
 The oven can emit an odour and smoke during preheating. Make sure that the room is ventilated.	

5.3 Wireless connection

To connect the appliance you need:

- Wireless network with the Internet connection.
- Mobile device connected to the same wireless network.

Step 1	To download My Electrolux Kitchen app: Scan the QR code on the rating plate with the camera on your mobile device to be redirected to Electrolux Homepage. The rating plate is on the front frame of the appliance cavity. You can also download the app directly from the app store.
Step 2	Follow the app onboarding instructions.
Step 3	Turn the knob for the heating functions to select: 
Step 4	Turn the control knob to select: Settings. Turn on Wi-Fi. Refer to "Menu Structure" chapter.

Frequency	2.4 GHz WLAN
	2400 - 2483.5 MHz
Protocol	IEEE 802.11b DSSS, 802.11g/n OFDM
Max Power	EIRP < 20 dBm (100 mW)
Wi-Fi module	NIUS-50

5.4 Software licences

The software in this product contains components that are based on free and open source software. Electrolux acknowledges the contributions of the open software and robotics communities to the development project.

To access the source code of these free and open source software components whose license conditions require publishing, and to see their full copyright information and applicable license terms, visit: <http://electrolux.opensourcerepository.com> (folder NIUS).

6. DAILY USE



WARNING!

Refer to Safety chapters.

6.1 How to set: Heating functions

Step 1	Turn the knob for the heating functions and select a heating function.
Step 2	Turn the control knob to set the temperature.
- press and hold to turn on the function: Fast Heat Up. It is available for some oven functions.	

Steam cooking

Make sure that the oven is cold.

Step 1	Step 2	Step 3	Step 4
			Preheat the empty oven for 10 min to create humidity. Put food in the oven.
Fill the cavity embossment with tap water.	Select the steam heating function.	Set the temperature.	

i The maximum capacity of the cavity embossment is 250 ml. Do not refill the cavity embossment during cooking or when the oven is hot.







When the steam cooking ends:



Step 1	Step 2	Step 3
---------------	---------------	---------------

When the steam cooking ends:

<p>Turn the knob for the heating functions to the off position to turn off the oven.</p>	<p>Carefully open the door. Released humidity can cause burns.</p>	<p>Make sure that the oven is cold. Remove the remaining water from the cavity embossment.</p>
--	--	--

6.2 Heating functions

Heating function	Application
 <p>True Fan Cooking</p>	<p>To bake on up to three shelf positions at the same time and to dry food. Set the temperature 20 - 40 °C lower than for Conventional Cooking.</p>
 <p>Conventional Cooking</p>	<p>To bake and roast food on one shelf position.</p>
 <p>SteamBake</p>	<p>To add humidity during the cooking. To get the right colour and crispy crust during baking. To give more juiciness during reheating. To preserve fruit or vegetables.</p>
 <p>Pizza Function</p>	<p>To bake pizza. To make intensive browning and a crispy bottom.</p>
 <p>Bottom Heat</p>	<p>To bake cakes with crispy bottom and to preserve food.</p>
 <p>Frozen Foods</p>	<p>To make convenience food (e.g., french fries, potato wedges or spring rolls) crispy.</p>
 <p>Moist Fan Baking</p>	<p>This function is designed to save energy during cooking. When you use this function, the temperature in the cavity may differ from the set temperature. The residual heat is used. The heating power may be reduced. For more information refer to "Daily Use" chapter, Notes on: Moist Fan Baking.</p>

Heating function	Application
 <p>Grill</p>	To grill thin pieces of food and to toast bread.
 <p>Turbo Grilling</p>	To roast large meat joints or poultry with bones on one shelf position. To make gratins and to brown.
 <p>Menu</p>	To enter the Menu: Assisted Cooking, Cleaning, Settings.

 True Fan Cooking, Conventional Cooking: When you set the temperature below 80 °C the lamp automatically turns off after 30 sec.

6.3 Notes on: Moist Fan Baking

This function was used to comply with the energy efficiency class and ecodesign requirements (according to EU 65/2014 and EU 66/2014). Tests according to: IEC/EN 60350-1

The oven door should be closed during cooking so that the function is not interrupted and the oven operates with the highest energy efficiency possible.

When you use this function the lamp automatically turns off after 30 sec.







For the cooking instructions refer to "Hints and tips" chapter, Moist Fan Baking. For general energy saving recommendations refer to "Energy Efficiency" chapter, Energy Saving.

6.4 How to set: Assisted Cooking





Every dish in this submenu has a recommended heating function and temperature. Use the function to prepare a dish quickly with default settings. You can also adjust the time and the temperature during cooking.

For some of the dishes you can also cook with:	The degree to which a dish is cooked:
<ul style="list-style-type: none"> Food Sensor 	<ul style="list-style-type: none"> Rare Medium Well done





Step 1	Step 2	Step 3	Step 4















 	 	 P1 - P45	 OK
Enter the menu.	Select Assisted Cooking. Press OK .	Select the dish. Press OK .	Insert the dish to the oven. Confirm setting.

























6.5 Assisted Cooking

Legend	
	Food sensor available. Place the Food sensor in the thickest part of the dish. The appliance turns off when the set Food sensor temperature is reached.
	The amount of water for the steam function.
	Preheat the appliance before you start cooking.
	Shelf level.

The display shows **P** and a **number** of the dish that you can check in the table.
When the function ends check if the food is ready.









	Dish	Weight	Shelf level / Accessory
1	Roast Beef, rare	1 - 1.5 kg; 4 - 5 cm thick pieces	  2 ; baking tray Fry the meat for a few minutes on a hot pan. Insert to the appliance.
2	Roast Beef, medium		
3	Roast Beef, well done		
4	Steak, medium	180 - 220 g per piece; 3 cm thick slices	   3 ; roasting dish on wire shelf Fry the meat for a few minutes on a hot pan. Insert to the appliance.

	Dish	Weight	Shelf level / Accessory
5	Beef roast / braised (prime rib, top round, thick flank)	1.5 - 2 kg	  2; roasting dish on wire shelf Fry the meat for a few minutes on a hot pan. Add liquid. Insert to the appliance.
6	Roast Beef, rare (slow cooking)	1 - 1.5 kg; 4 - 5 cm thick pieces	  2; baking tray Use your favourite spices or simply salt and fresh grounded pepper. Fry the meat for a few minutes on a hot pan. Insert to the appliance.
7	Roast Beef, medium (slow cooking)		
8	Roast Beef, well done (slow cooking)		
9	Fillet, rare (slow cooking)	0,5 - 1.5 kg; 5 - 6 cm thick pieces	  2; baking tray Use your favourite spices or simply salt and fresh grounded pepper. Fry the meat for a few minutes on a hot pan. Insert to the appliance.
10	Fillet, medium (slow cooking)		
11	Fillet, done (slow cooking)		
12	Veal roast (e.g. shoulder)	0.8 - 1.5 kg; 4 cm thick pieces	  2; roasting dish on wire shelf Use your favourite spices. Add liquid. Roast covered.
13	Pork roast neck or shoulder	1.5 - 2 kg	 2; roasting dish on wire shelf Turn the meat after half of the cooking time.
14	Pulled pork (slow cooking)	1.5 - 2 kg	  2; baking tray Use your favourite spices. Turn the meat after half of the cooking time to get an even browning.
15	Loin, fresh	1 - 1.5 kg; 5 - 6 cm thick pieces	  2; roasting dish on wire shelf Use your favourite spices.
16	Spare Ribs	2 - 3 kg; use raw, 2 - 3 cm thin spare ribs	 3; deep pan Add liquid to cover the bottom of a dish. Turn the meat after half of the cooking time.

	Dish	Weight	Shelf level / Accessory
17	Lamb leg with bones	1.5 - 2 kg; 7 - 9 cm thick pieces	  2; roasting dish on baking tray Add liquid. Turn the meat after half of the cooking time.
18	Whole chicken	1 - 1.5 kg; fresh	  2;  200 ml; casserole dish on baking tray Use your favourite spices. Turn the chicken after half of the cooking time to get an even browning.
19	Half chicken	0.5 - 0.8 kg	  3; baking tray Use your favourite spices.
20	Chicken breast	180 - 200 g per piece	   2; casserole dish on wire shelf Use your favourite spices. Fry the meat for a few minutes on a hot pan.
21	Chicken legs, fresh	-	  3; baking tray If you marinated chicken legs first, set lower temperature and cook them longer.
22	Duck, whole	2 - 3 kg	  2; roasting dish on wire shelf Use your favourite spices. Put the meat on roasting dish. Turn the duck after half of the cooking time.
23	Goose, whole	4 - 5 kg	  2; deep pan Use your favourite spices. Put the meat on deep baking tray. Turn the goose after half of the cooking time.
24	Meat loaf	1 kg	  2; wire shelf Use your favourite spices.
25	Whole fish, grilled	0.5 - 1 kg per fish	  2; baking tray Fill the fish with butter and use your favourite spices and herbs.
26	Fish fillet	-	  3; casserole dish on wire shelf Use your favourite spices.
27	Cheesecake	-	 2;  28 cm springform tin on wire shelf





	Dish	Weight	Shelf level / Accessory
28	Apple cake	-	☐ 2; 🍷 100 - 150 ml; baking tray
29	Apple tart	-	☐ 2; pie form on wire shelf
30	Apple pie	-	☐ 2; 🍷 100 - 150 ml; ∅ 22 cm pie form on wire shelf
31	Brownies	2 kg of dough	☐ 3; deep pan
32	Chocolate muffins	-	☐ 2; 🍷 100 - 150 ml; muffin tray on wire shelf
33	Loaf cake	-	☐ 2; loaf pan on wire shelf
34	Baked potatoes	1 kg	☐ 2; baking tray Put the whole potatoes with skin on baking tray.
35	Wedges	1 kg	☐ 3; baking tray lined with baking paper Use your favourite spices. Cut potatoes into pieces.
36	Grilled mixed vegetables	1 - 1.5 kg	☐ 3; baking tray lined with baking paper Use your favourite spices. Cut the vegetables into pieces.
37	Croquets, frozen	0.5 kg	☐ 3; baking tray
38	Pommes, frozen	0.75 kg	☐ 3; baking tray
39	Meat / vegetable lasagna with dry noodle plates	1 - 1.5 kg	☐ 2; casserole dish on wire shelf
40	Potato gratin (raw potatoes)	1 - 1.5 kg	☐ 1; casserole dish on wire shelf Rotate the dish after half of the cooking time.
41	Pizza fresh, thin	-	☐ 1 ☐ 2; 🍷 100 ml; baking tray lined with baking paper

CLOCK FUNCTIONS

	Dish	Weight	Shelf level / Accessory
42	Pizza fresh, thick	-	  2; baking tray lined with baking paper
43	Quiche	-	 2; baking tin on wire shelf
44	Baguette / Ciabatta / White bread	0.8 kg	  2;  150 ml; baking tray lined with baking paper More time needed for white bread.
45	All grain / rye / dark bread all grain in loaf pan	1 kg	  2;  150 ml; baking tray lined with baking paper / wire shelf



7. CLOCK FUNCTIONS







7.1 Clock functions







Clock Function	Application
 Minute minder	When the timer ends, the signal sounds.
 Cooking time	When the timer ends, the signal sounds and the heating function stops.
 Time Delay	To postpone the start and / or end of cooking.
 Uptimer	Maximum is 23 h 59 min. This function has no effect on the operation of the oven. To turn on and off the Uptimer select: Menu, Settings.

7.2 How to set: Clock functions











How to set: Time of day		
Step 1	Step 2	Step 3

How to set: Time of day		
		
To change the time of day enter the menu and select Settings, Time of day.	Set the clock.	Press: OK.

How to set: Minute minder			
Step 1	The display shows: 0:00 	Step 2	Step 3
			
Press:  .		Set the Minute minder	Press: OK.
 Timer starts counting down immediately.			

How to set: Cooking time				
Step 1	Step 2	The display shows: 0:00  STOP	Step 3	Step 4
				
Choose a heating function and set the temperature.	Press repeatedly:  .		Set the cooking time.	Press: OK.
 Timer starts counting down immediately.				

USING THE ACCESSORIES

How to set: Time Delay							
Step 1	Step 2		Step 3	Step 4		Step 5	Step 6
		The display shows: the time of day  START			The display shows: ---  STOP		
Select the heating function.	Press repeatedly: 		Set the start time.	Press: OK.		Set the end time.	Press: OK.
 Timer starts counting down at a set start time.							

8. USING THE ACCESSORIES

 **WARNING!**
Refer to Safety chapters.

8.1 Inserting accessories

A small indentation at the top increases safety. The indentations are also anti-tip devices. The high rim around the shelf prevents cookware from slipping of the shelf.

Wire shelf:
Push the shelf between the guide bars of the shelf support.

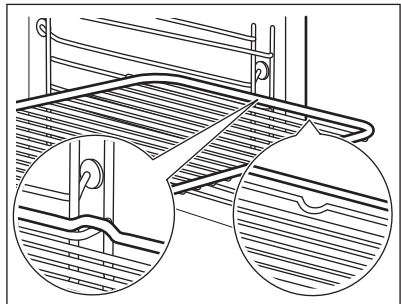

Baking tray / Deep pan:
Push the tray between the guide bars of the shelf support.

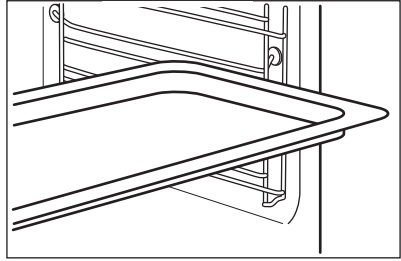

8.2 Food Sensor

Food Sensor - measures the temperature inside the food.

There are two temperatures to be set:



The oven temperature.



The core temperature.

For the best cooking results:

Ingredients should be at room temperature.

Do not use it for liquid dishes.



During cooking it must remain in the dish.

How to use: Food Sensor

Step 1	Turn on the oven.
Step 2	Set a heating function and, if necessary, the oven temperature.
Step 3	Insert: Food Sensor.
Meat, poultry and fish	Casserole
Insert the tip of Food Sensor into the centre of meat, fish, in the thickest part if possible. Make sure that at least 3/4 of Food Sensor is inside of the dish.	Insert the tip of Food Sensor exactly in the centre of the casserole. Food Sensor should be stabilized in one place during baking. Use a solid ingredient to achieve that. Use the rim of the baking dish to support the silicone handle of Food Sensor. The tip of Food Sensor should not touch the bottom of a baking dish.

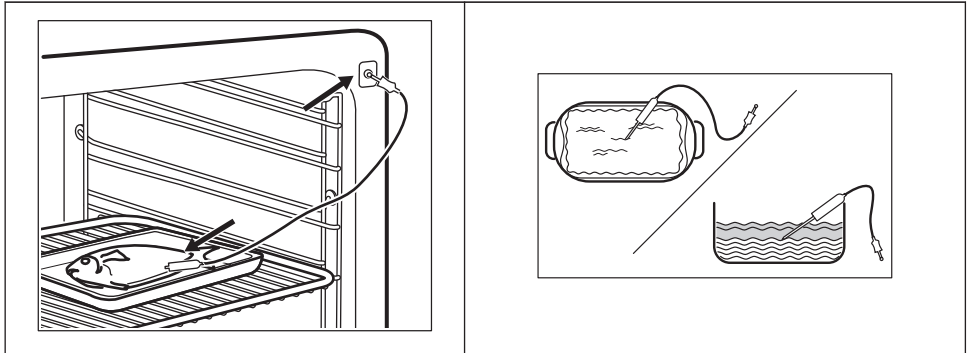





ADDITIONAL FUNCTIONS



<p>Step 4</p>	<p>Plug Food Sensor into the socket at the front of the oven. The display shows the current temperature of: Food Sensor.</p>
<p>Step 5</p>	<p> - press to set the core temperature of the sensor.</p>
<p>Step 6</p>	<p>OK - press to confirm. When food reaches the set temperature, the signal sounds. You can choose to stop or to continue cooking to make sure the food is well done.</p>
<p>Step 7</p>	<p>Remove Food Sensor plug from the socket and remove the dish from the oven.</p> <div style="border: 1px solid black; padding: 5px; margin-top: 10px;"> <p> WARNING! There is a risk of burns as Food Sensor becomes hot. Be careful when you unplug it and remove it from the food.</p> </div>



9. ADDITIONAL FUNCTIONS

9.1 Lock

<p>This function prevents an accidental change of the appliance function.</p>		
<p>Turn it on when the appliance works - the set cooking continues, the control panel is locked. Turn it on when the appliance is off - it cannot be turned on, the control panel is locked.</p>		
<p> </p>	<p> OK - press and hold to turn on the function. A signal sounds.</p>	<p> OK - press and hold to turn it off.</p>
<p> 3 x  - flashes when the lock is turned on.</p>		

9.2 Automatic switch-off

For safety reasons the appliance turns off after some time, if a heating function works and you do not change any settings.

 (°C)	 (h)
30 - 115	12.5
120 - 195	8.5
200 - 245	5.5
250 - maximum	3

The Automatic switch-off does not work with the functions: Light, Food sensor, Time Delay.

9.3 Cooling fan

When the appliance operates, the cooling fan turns on automatically to keep the surfaces of the appliance cool. If you turn off the appliance, the cooling fan can continue to operate until the appliance cools down.

9.4 Mechanical door lock

The door lock is unlocked when you buy the oven.

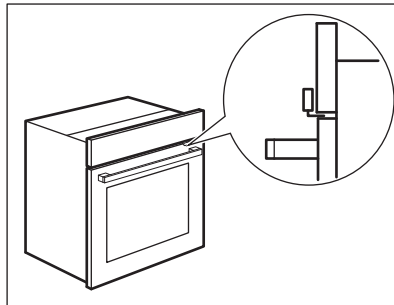

ADDITIONAL FUNCTIONS

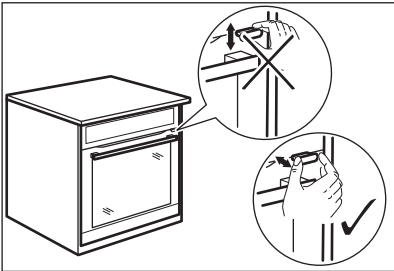
<p> CAUTION! Do not move the door lock vertically. Do not push the door lock when you close the oven door.</p>	
--	---

9.5 How to use: Mechanical door lock

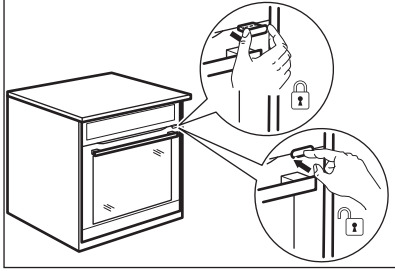
Step 1	To lock the door pull the door lock forward until it locks.
Step 2	To unlock the door push the door lock back into the panel. 

Opening the locked door

You can open the door when the door lock is locked.

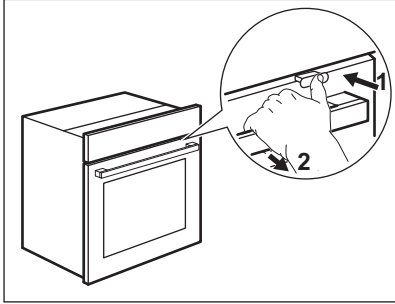
Step 1	Push the door lock slightly and open the door by pulling it with the handle. 
---------------	---

When you close the door make sure that the door lock remains locked.

10. HINTS AND TIPS

10.1 Cooking recommendations



The temperature and cooking times in the tables are guidelines only. They depend on the recipes and the quality and quantity of the ingredients used.



Your appliance may bake or roast differently to the appliance you had before. The hints below show recommended settings for temperature, cooking time and shelf position for specific types of the food.

If you cannot find the settings for a special recipe, look for the similar one.

10.2 Moist Fan Baking

For the best results follow suggestions listed in the table below.



Use the third shelf position.

	 (°C)	 (min)
Pasta gratin	200 - 220	45 - 55
Potato gratin	180 - 200	70 - 85
Moussaka	170 - 190	70 - 95
Lasagne	180 - 200	75 - 90
Cannelloni	180 - 200	70 - 85
Bread pudding	190 - 200	55 - 70
Rice pudding	170 - 190	45 - 60
Apple cake, made of sponge cake mixture (round cake tin)	160 - 170	70 - 80
White bread	190 - 200	55 - 70

10.3 Moist Fan Baking - recommended accessories

Use the dark and non-reflective tins and containers. They have better heat absorption than the light colour and reflective dishes.

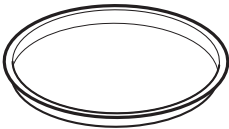
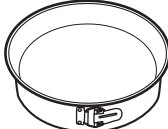



HINTS AND TIPS

			
Pizza pan	Baking dish	Ramekins	Flan base tin
Dark, non-reflective 28 cm diameter	Dark, non-reflective 26 cm diameter	Ceramic 8 cm diameter, 5 cm height	Dark, non-reflective 28 cm diameter

10.4 Cooking tables for test institutes





Information for test institutes

Tests according to: EN 60350, IEC 60350.
Baking on one level - baking in tins





		 °C	 min	
Fatless sponge cake	True Fan Cooking	160	45 - 60	2
Fatless sponge cake	Conventional Cooking	160	45 - 60	2
Apple pie, 2 tins Ø20 cm	True Fan Cooking	160	55 - 65	2
Apple pie, 2 tins Ø20 cm	Conventional Cooking	180	55 - 65	1
Short bread	True Fan Cooking	140	25 - 35	2
Short bread	Conventional Cooking	140	25 - 35	2

Baking on one level - biscuits
Use the third shelf position.

CARE AND CLEANING

		 °C	 min
Small cakes, 20 per tray, preheat the empty oven	True Fan Cooking	150	20 - 30
Small cakes, 20 per tray, preheat the empty oven	Conventional Cooking	170	20 - 30





Multilevel baking - biscuits

		 °C	 min	
Short bread	True Fan Cooking	140	25 - 45	2 / 4
Small cakes, 20 per tray, preheat the empty oven	True Fan Cooking	150	25 - 35	1 / 4
Fatless sponge cake	True Fan Cooking	160	45 - 55	2 / 4
Apple pie, 1 tin per grid (Ø 20 cm)	True Fan Cooking	160	55 - 65	2 / 4

Grill

Preheat the empty oven for 5 minutes.

Grill with the maximum temperature setting.

		 min	
Toast	Grill	1 - 2	5
Beef steak, turn halfway through	Grill	24 - 30	4

11. CARE AND CLEANING





WARNING!

Refer to Safety chapters.

CARE AND CLEANING

11.1 Notes on cleaning

 Cleaning Agents	Clean the front of the appliance only with a microfibre cloth with warm water and a mild detergent.
	Use a cleaning solution to clean metal surfaces.
	Clean stains with a mild detergent.
 Everyday Use	Clean the cavity after each use. Fat accumulation or other residue may cause fire.
	Do not store the food in the appliance for longer than 20 minutes. Dry the cavity only with a microfibre cloth after each use.
 Accessories	Clean all accessories after each use and let them dry. Use only a microfibre cloth with warm water and a mild detergent. Do not clean the accessories in a dishwasher.
	Do not clean the non-stick accessories using abrasive cleaner or sharp-edged objects.

11.2 How to clean: Cavity embossment

Clean the cavity embossment to remove limestone residue after cooking with steam.

Step 1	Step 2	Step 3
Pour: 250 ml of white vinegar into the cavity embossment. Use maximum 6% vinegar without any additives.	Let the vinegar dissolve the limestone residue at the ambient temperature for 30 minutes.	Clean the cavity with warm water and a soft cloth.
For the function: SteamBake clean the oven for every 5 - 10 cooking cycles.		

11.3 How to remove: Shelf supports

Remove the shelf supports to clean the oven.

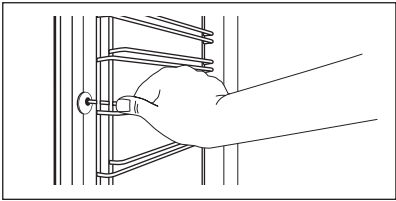
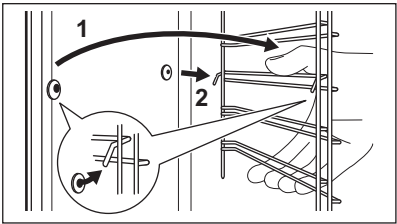
Step 1	Turn off the oven and wait until it is cold.	
Step 2	Pull the front of the shelf support away from the side wall.	
Step 3	Pull the rear end of the shelf support away from the side wall and remove it.	
Step 4	Install the shelf supports in the opposite sequence.	

11.4 How to use: Pyrolytic Cleaning

Clean the oven with Pyrolytic Cleaning.



WARNING!

There is a risk of burns.



CAUTION!

If there are other appliances installed in the same cabinet, do not use them at the same time as this function. It can cause damage to the oven.



Before the Pyrolytic Cleaning:

Turn off the oven and wait until it is cold.	Remove all accessories and removable shelf supports.	Clean the oven floor and the inner door glass with warm water, a soft cloth and a mild detergent.
--	--	---

Pyrolytic Cleaning

Step 1	Enter menu: Cleaning $\text{m} / \text{.}$	
Option	Duration	
C1 - Light cleaning	1 h	
C2 - Normal cleaning	1 h 30 min	

CARE AND CLEANING

Pyrolytic Cleaning	
C3 - Thorough cleaning	3 h
Step 2	OK - press to select the cleaning programme.
Step 3	OK - press to start the cleaning.
Step 4	After cleaning, turn the knob for the heating functions to the off position.
 When the cleaning starts, the oven door is locked and the lamp is off. Until the door unlocks the display shows:  .	



When the cleaning ends:		
Turn off the oven and wait until it is cold.	Clean the cavity with a soft cloth.	Remove the residue from the bottom of the cavity.

11.5 Cleaning Reminder

The oven reminds you when to clean it with pyrolytic cleaning.	
 flashes in the display for 5 sec after each cooking session.	To turn off the reminder enter the Menu and select Settings, Cleaning Reminder.

11.6 How to remove and install: Door

You can remove the door and the internal glass panels to clean it. The number of glass panels is different for different models.

 WARNING! The door is heavy.
 CAUTION! Carefully handle the glass, especially around the edges of the front panel. The glass can break.

CARE AND CLEANING

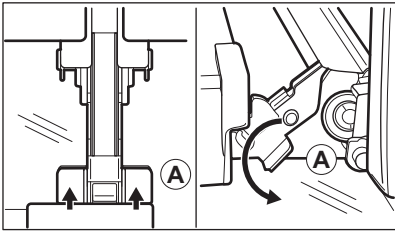
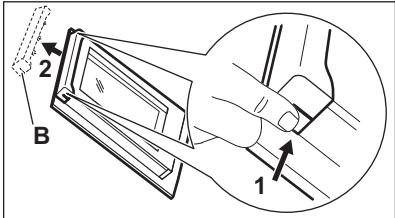
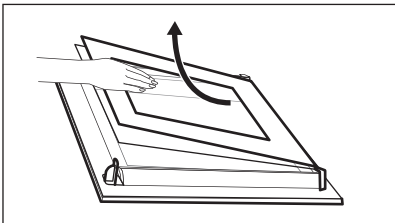
Step 1	Fully open the door.	
Step 2	Lift and press the clamping levers (A) on the two door hinges.	
Step 3	Close the oven door to the first opening position (approximately 70° angle). Hold the door at both sides and pull it away from the oven at an upwards angle. Put the door with the outer side down on a soft cloth on a stable surface.	
Step 4	Hold the door trim (B) on the top edge of the door at the two sides and push inwards to release the clip seal.	
Step 5	Pull the door trim to the front to remove it.	
Step 6	Hold the door glass panels on their top edge one by one and pull them up out of the guide.	
Step 7	Clean the glass panel with water and soap. Dry the glass panel carefully. Do not clean the glass panels in the dishwasher.	
Step 8	After cleaning, do the above steps in the opposite sequence.	
Step 9	Install the smaller panel first, then the larger and the door. Make sure that the glasses are inserted in the correct position otherwise the surface of the door may overheat.	

11.7 How to replace: Lamp



WARNING!

Risk of electric shock.
The lamp can be hot.

TROUBLESHOOTING

Before you replace the lamp:

Step 1	Step 2	Step 3
Turn off the oven. Wait until the oven is cold.	Disconnect the oven from the mains.	Put a cloth on the bottom of the cavity.

Top lamp

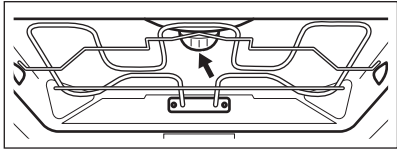
Step 1	Turn the glass cover to remove it.	
Step 2	Clean the glass cover.	
Step 3	Replace the lamp with a suitable 300 °C heat-resistant lamp.	
Step 4	Install the glass cover.	

Side lamp

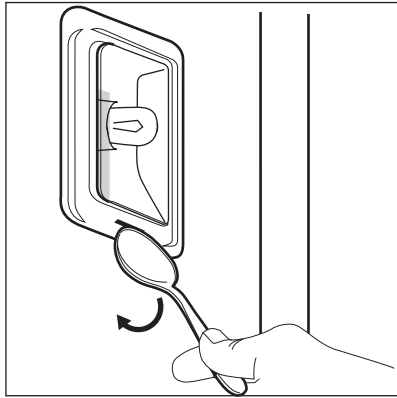
Step 1	Remove the left shelf support to get access to the lamp.	
Step 2	Use a narrow, blunt object (e.g. a teaspoon) to remove the glass cover.	
Step 3	Clean the glass cover.	
Step 4	Replace the lamp with a suitable 300 °C heat-resistant lamp.	
Step 5	Install the glass cover.	
Step 6	Install the left shelf support.	

12. TROUBLESHOOTING





WARNING!

Refer to Safety chapters.

12.1 What to do if...

In any cases not included in this table please contact with an Authorised Service Centre.

 The appliance does not turn on or does not heat up	
Problem	Check if...
You cannot activate or operate the appliance.	The appliance is correctly connected to an electrical supply.
The appliance does not heat up.	The automatic switch-off is deactivated.
The appliance does not heat up.	The appliance door is closed.
The appliance does not heat up.	The fuse is not blown.
The appliance does not heat up.	The Lock is off.

 Components	
Problem	Check if...
The lamp is turned off.	Moist Fan Baking - is turned on.
The lamp does not work.	The lamp is burnt out.
The Food sensor does not operate.	The plug of the Food sensor is fully inserted into the socket.

 Error codes	
The display shows...	Check if...
Err C2	You removed the Food sensor plug from the socket.
Err C3	The appliance door is closed or the door lock is not broken.
Err F102	The appliance door is closed.

ENERGY EFFICIENCY



Error codes

Err F102	The door lock is not broken.
00:00	There was a power cut. Set the time of day.
If the display shows an error code that is not in this table turn the house fuse off and on to restart the appliance. If the error code recurs contact an Authorised Service Centre.	



Cleaning

Problem	Check if...
The water leaks out of the cavity embossment.	There is too much water in the cavity embossment.

12.2 Service data

If you cannot find a solution to the problem yourself, contact your dealer or an Authorised Service Centre.

The necessary data for the service centre is on the rating plate. The rating plate is on the front frame of the appliance cavity. Do not remove the rating plate from the appliance cavity.

We recommend that you write the data here:

Model (MOD.)
Product number (PNC)
Serial number (S.N.)

13. ENERGY EFFICIENCY

13.1 Product Information and Product Information Sheet

Supplier's name	Electrolux
Model identification	COP827V 944032113 COP827X 944032112 EO82PBK 944032114

Energy Efficiency Index	81.2	
Energy efficiency class	A+	
Energy consumption with a standard load, conventional mode	1.09 kWh/cycle	
Energy consumption with a standard load, fan-forced mode	0.69 kWh/cycle	
Number of cavities	1	
Heat source	Electricity	
Volume	71 l	
Type of oven	Built-In Oven	
Mass	COP827V	35.0 kg
	COP827X	35.0 kg
	EO82PBK	35.0 kg

IEC/EN 60350-1 - Household electric cooking appliances - Part 1: Ranges, ovens, steam ovens and grills - Methods for measuring performance.

13.2 Energy saving



The appliance has features which help you save energy during everyday cooking.

Make sure that the appliance door is closed when the appliance operates. Do not open the appliance door too often during cooking. Keep the door gasket clean and make sure it is well fixed in its position.

Use metal cookware to improve energy saving.

When possible, do not preheat the appliance before cooking.

Keep breaks between baking as short as possible when you prepare a few dishes at one time.

Cooking with fan

When possible, use the cooking functions with fan to save energy.

Residual heat

The fan and lamp continue to operate. When you turn off the appliance, the display shows the residual heat. You can use that heat to keep the food warm.

When the cooking duration is longer than 30 min, reduce the appliance temperature to minimum 3 - 10 min before the end of cooking. The residual heat inside the appliance will continue to cook.

Use the residual heat to warm up other dishes.

MENU STRUCTURE

Keep food warm

Choose the lowest possible temperature setting to use residual heat and keep a meal warm. The residual heat indicator or temperature appears on the display.

Cooking with the lamp off

Turn off the lamp during cooking. Turn it on only when you need it.







Moist Fan Baking



Function designed to save energy during cooking.

When you use this function the lamp automatically turns off after 30 sec. You may turn on the lamp again but this action will reduce the expected energy savings.

14. MENU STRUCTURE

14.1 Menu



Step 1	Step 2	Step 3	Step 4	Step 5
				
 - select to enter the Menu.	Select the option from Menu structure and press OK .	Select the setting.	OK - press to confirm setting.	Adjust the value and press OK .
Turn the knob for the heating functions to the off position to exit the Menu.				

Menu structure		
Assisted Cooking 	Cleaning 	Settings 

Settings					
01	Time of day	Change	02	Display brightness	1 - 5
03	Key tones	1 - Beep 2 - Click 3 - Sound off	04	Buzzer volume	1 - 4
05	Food Sensor Action	1 - Alarm and stop 2 - Alarm	06	Uptimer	On / Off
07	Light	On / Off	08	Fast Heat Up	On / Off

Settings					
09	Cleaning Reminder	On / Off	10	Wi-Fi	On / Off
11	Auto remote operation	On / Off	12	Forget network	Yes / No
13	Demo mode	Activation code: 2468	14	Software version	Check
15	Reset all settings	Yes / No			

15. ENVIRONMENTAL CONCERNS

Recycle materials with the symbol . Put the packaging in relevant containers to recycle it. Help protect the environment and human health by recycling waste of electrical and electronic appliances. Do not dispose of appliances marked with the symbol  with the household waste. Return the product to your local recycling facility or contact your municipal office.

TERVETULOA ELECTROLUXIIN! KIITOS, ETTÄ OLET VALINNUT TÄMÄN LAITTEEN.



Vähennämme paperin käyttöä suojellaksemme ympäristöä. Täydelliset ohjekirjat ovat saatavilla verkossa. Täydellinen ohjekirja on saatavilla osoitteessa **electrolux.com/manuals**



Voit tarkastella käyttöön liittyviä neuvoja, esitteitä, vianmääritysohjeita sekä huolto- ja korjausohjeita osoitteessa **electrolux.com/support**



Saats lisää reseptejä, vinkkejä, vianetsintäohjeita lataamalla **My Electrolux Kitchen** sovellus.



SISÄLTÖ

1. TURVALLISUUSTIEDOT.....	82	6.4 Asetukset: Avustava ruoanvalmistus.....	94
1.1 Lasten ja taitamattomien henkilöiden turvallisuus.....	82	6.5 Avustava ruoanvalmistus.....	95
1.2 Yleinen turvallisuus.....	82	7. KELLOTOIMINNOT.....	99
2. TURVALLISUUSOHJEET.....	84	7.1 Kellotoiminnot.....	99
2.1 Asennus.....	84	7.2 Asetukset: Kellotoiminnot.....	100
2.2 Sähkökytkentä.....	85	8. LISÄVARUSTEIDEN KÄYTTÄMINEN....	101
2.3 Valitse.....	85	8.1 Lisävarusteiden asennus.....	101
2.4 Hoito ja puhdistus.....	86	8.2 Paistolämpömittari.....	102
2.5 Pyrolyyttinen puhdistus.....	86	9. LISÄTOIMINNOT.....	103
2.6 Sisävalaistus.....	87	9.1 Lukko.....	103
2.7 Huolto.....	87	9.2 Automaattinen virrankatkaisu.....	104
2.8 Hävittäminen.....	87	9.3 Jäähdytyspuhallin.....	104
3. TUOTEKUVAUS.....	88	9.4 Mekaanin luukun lukko.....	104
3.1 Yleiskatsaus.....	88	9.5 Käyttöohje: Mekaanin luukun lukko.....	105
3.2 Varusteet.....	88	10. VIHJEITÄ JA NEUVOJA.....	106
4. KÄYTTÖPANEELI.....	89	10.1 Ruoanlaittoon liittyviä suosituksia.....	106
4.1 Sisäänpainettava vääntimet.....	89	10.2 Kosteaa kiertoilma.....	106
4.2 Ohjauspaneelin yleisnäkymä.....	89	10.3 Kosteaa kiertoilma – suositellut varusteet.....	106
4.3 Näyttö.....	89	10.4 Testilaitosten ruoanvalmistustaulukot.....	107
5. ENNEN ENSIKÄYTTÖÄ.....	90	11. HOITO JA PUHDISTUS.....	109
5.1 Alkupuhdistus.....	90	11.1 Puhdistukseen liittyviä huomautuksia.....	109
5.2 Alustava esikuumennus.....	91	11.2 Puhdistaminen: Lokeron reliefi..	109
5.3 Langaton yhteys 	91	11.3 Irrottaminen: Kannattimet	109
5.4 Ohjelmistolisenssit.....	92	11.4 Käyttöohje: Pyrolyyttinen puhdistus.....	110
6. PÄIVITTÄINEN KÄYTTÖ.....	92		
6.1 Asetukset: Uunitoiminnot.....	92		
6.2 Uunitoiminnot.....	93		
6.3 Huomautus: Kosteaa kiertoilma.....	94		

11.5 Muistutus puhdistamisesta.....	111	13.2 Energiansäästö.....	116
11.6		14. VALIKKORAKENNE.....	117
Irrottaminen ja asentaminen: Luukku.....	111	14.1 Valikko.....	117
11.7 Vaihtaminen: Lamppu.....	112	15. YMPÄRISTÖNSUOJELU.....	118
12. VIANMÄÄRITYS.....	113		
12.1 Käyttöhäiriöt.....	114		
12.2 Huoltotiedot.....	115		
13. ENERGIATEHOKKUUS.....	115		
13.1 Tuotetiedot ja tuotteen tietolomake.....	115		

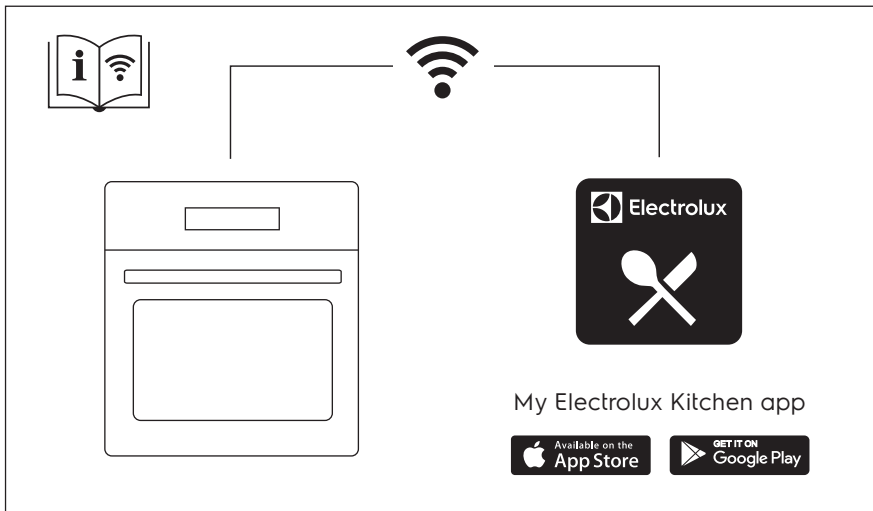

Oikeus muutoksiin pidätetään.

1. ⚠ TURVALLISUUSTIEDOT

Lue laitteen mukana toimitetut ohjeet ennen laitteen asennusta ja käyttöä. Valmistaja ei ota vastuuta henkilövahingoista tai vahingoista, jotka aiheutuvat virheellisestä asennuksesta tai käytöstä. Säilytä ohjeita aina varmassa ja helpopääsyisessä paikassa tulevia käyttökertoja varten.

1.1 Lasten ja taitamattomien henkilöiden turvallisuus

- 8-vuotiaat ja sitä vanhemmat lapset sekä henkilöt, joilla on fyysisiä, aisteihin liittyviä tai henkisiä rajoitteita tai puutteellinen kokemus tai tuntemus, voivat käyttää tätä laitetta vain, jos heitä valvotaan tai ohjataan laitteen turvallisessa käytössä ja jos he ymmärtävät käyttöön liittyvät vaarat. Tuote on pidettävä alle 8-vuotiaiden lasten ja erittäin laajoista ja monimutkaisista toiminnallisista rajoitteista kärsivien henkilöiden ulottumattomissa, ellei heitä valvota jatkuvasti.
- Lapsia on valvottava, jotta he eivät ryhdy leikkimään laitteella ja mobiililaitteilla My Electrolux Kitchen .
- Kaikki pakkaukset tulee pitää lasten ulottumattomissa ja hävittää asianmukaisesti.
- VAROITUS: Uuni ja sen esilläolevat osat kuumentuvat käytön aikana. Pidä lapset ja lemmikkieläimet poissa laitteen lähetyviltä sen ollessa toiminnassa tai jäähtymässä.
- Jos laitteessa on lapsilukko, sitä on käytettävä.
- Lapset eivät saa puhdistaa laitetta tai suorittaa siihen kohdistuvia käyttäjän huoltotoimenpiteitä ilman valvontaa.

1.2 Yleinen turvallisuus

- Tämä laite on tarkoitettu ainoastaan ruoanlaittoon.
- Tämä laite on tarkoitettu yhden kotitalouden käyttöön sisätiloissa.

- Tätä laitetta voidaan käyttää toimistoissa, hotellihuoneissa, aamiaismajoituspaikoissa, maatilamajoituspaikoissa ja muissa samantyyppisissä majoitustiloissa, joissa kyseinen käyttö ei ylitä (keskimääräisiä) kotitalouskäytön tasoja.
- Laitteen asennuksen ja virtajohdon vaihtamisen saa suorittaa vain alan ammattilainen.
- Älä käytä laitetta ennen kuin se on asennettu kalusteeseen.
- Irrota laite sähköverkosta ennen huoltotoimenpiteiden suorittamista.
- Jos virtajohto vaurioituu, sen saa vaihtaa vain valmistaja, valtuutettu huoltoliike tai vastaava ammattitaitoinen henkilö, jotta vältetään sähkövaaroilta.
- VAROITUS: Varmista, että laite on kytketty pois päältä ennen kuin ryhdyt vaihtamaan lampua välttääksesi sähköiskun vaaran.
- VAROITUS: Uuni ja sen esilläolevat osat kuumentuvat käytön aikana. Vältä koskettamasta lämpövastuksia tai laitteen sisätilan pintoja.
- Käytä suojakäsineitä poistaessasi varusteita tai uunivuokia tai asettaessasi niitä laitteen sisälle.
- Käytä ainoastaan tähän laitteeseen suositeltua paistolämpömittaria.
- Poista hyllytuet vetämällä ensin hyllytuen etuosa ja sitten takaosa irti sivuseinistä. Asenna hyllytuet päinvastaisessa järjestyksessä.
- Laitteen puhdistuksessa ei saa käyttää höyrypesuria.
- Älä käytä hankausaineita tai teräviä metallikaapimia lasiluukun puhdistamisessa, sillä ne voivat naarmuttaa pintaa, mistä voi olla seurauksena lasin särkyminen.
- Kaikki varusteet ja liialliset roiskeet/jäämät on poistettava laitteen lokerosta ennen pyrolyyttistä puhdistusta.

2. TURVALLISUUSOHJEET

2.1 Asennus

**VAROITUS!**

Asennuksen saa suorittaa vain ammattitaitoinen henkilö.

- Poista kaikki pakkausmateriaalit.
- Vaurioitunutta laitetta ei saa asentaa tai käyttää.
- Noudata koneen mukana toimitettuja asennusohjeita.
- Siirrä laitetta aina varoen, sillä se on raskas. Käytä aina suojakäsineitä ja suojaavia jalkineita.
- Älä koskaan vedä laitetta sen kahvasta kiinni pitäen.
- Asenna laite turvalliseen ja sopivaan paikkaan, joka täyttää asennusvaatimukset.
- Noudata mainittuja vähimmäisetäisyyksiä muihin laitteisiin ja kalusteisiin.
- Tarkista ennen laitteen asentamista, että laitteen luukku avautuu esteettä.
- Laite on varustettu sähkötoimisella jäähdytysjärjestelmällä. Sitä on käytettävä sähkösyötöllä.
- Kalusteisiin asennettavan yksikön on täytettävä standardin DIN 68930 asettamat vaatimukset.

Kaapin vähimmäiskorkeus (työtason alla olevan kaapin vähimmäiskorkeus)	578 (600) mm
Kaapin leveys	560 mm
Kaapin syvyys	550 (550) mm
Laitteen etuosan korkeus	594 mm
Laitteen takaosan korkeus	576 mm
Laitteen etuosan leveys	595 mm
Laitteen takaosan leveys	559 mm
Laitteen syvyys	567 mm
Laitteen asennussyvyys	546 mm
Leveys luukun ollessa auki	1027 mm
Tuuletusaukon vähimmäiskoko. Aukko alaosassa takana	560x20 mm
Virtajohdon pituus. Johto sijaitsee oikeassa kulmassa takana	1500 mm
Kiinnitysruuvit	4x25 mm

2.2 Sähkökytkentä

**VAROITUS!**

Tulipalo- ja sähköiskuvaara.

- Kaikki sähkökytkennät tulee jättää asiantuntevan sähköasentajan vastuulle.
- Laite on kytkettävä maadoitettuun pistorasiaan.
- Varmista, että arvokilvessä olevat parametrit ovat verkkovirtalähteen sähköarvojen mukaisia.
- Kytke pistoke maadoitettuun pistorasiaan.
- Älä käytä jakorasioita tai jatkojohtoja.
- Varmista, ettei pistoke ja virtajohto vaurioidu. Jos virtajohto joudutaan vaihtamaan, vaihdon saa suorittaa vain valtuutettu huoltoliike.
- Älä anna virtajohtojen koskettaa laitteen luukkuja tai päästä niitä luukun tai laitteen alapuolella olevan asennustilan lähelle, varsinkaan laitteen ollessa toiminnassa tai luukun ollessa kuuma.
- Jännitteenalaisten ja eristettyjen osien suojat tulee asentaa niin, ettei niiden irrotus onnistu ilman työkaluja.
- Kytke pistoke pistorasiaan vasta asennuksen jälkeen. Varmista, että laitteen verkkovirtakytkentä on olottuvilla laitteen asennuksen jälkeen.
- Jos pistoke on löysästi kiinni virtajohdossa, älä kiinnitä sitä pistorasiaan.
- Älä vedä virtajohdosta pistoketta irrottaessasi. Vedä aina pistokkeesta.
- Käytä vain asianmukaisia eristyslaitteita: suojakytkimet, sulakkeet (ruuvattavat sulakkeet on irrotettava kannasta), vikavirtakytkimet ja kontaktorit.
- Sähköasennuksessa on oltava erotin, joka mahdollistaa laitteen irrottamisen sähköverkosta kaikista navoista. Erottimen kontaktiaukon leveys on oltava vähintään 3 mm.
- Sulje laitteen luukku kokonaan ennen pistokkeen liittämistä pistorasiaan.
- Laitteen mukana toimitetaan päävirtajohto ja pääpistoke.

2.3 Valitse

**VAROITUS!**

Henkilövahinkojen, palovammojen ja sähköiskujen tai räjähdysvaara.

- Älä muuta laitteen teknisiä ominaisuuksia.
- Varmista, että tuuletusaukoissa ei ole tukoksia.
- Laitetta ei saa jättää päälle valvomatta.
- Kytke laite pois päältä jokaisen käyttökerran jälkeen.
- Noudata varovaisuutta avatessasi laitteen luukun laitteen ollessa toiminnassa. Laitteesta voi purkautua ulos kuumaa ilmaa.
- Älä käytä laitetta, jos kätesi ovat märät tai laitteen ollessa kosketuksessa veteen.
- Älä kohdistaa painetta avoimeen oveen.
- Älä käytä laitetta työtasona tai tavaroiden säilytystasona.
- Avaa laitteen luukku varovaisuutta noudattaen. Alkoholipitoisten ainesosien käyttämisen tuloksena voi muodostua alkoholin ja ilman seoksia.
- Älä päästä kipinöitä tai avotulta kosketukseen laitteen kanssa avatessasi sen luukun.
- Älä aseta helposti syttyviä tuotteita tai helposti syttyvien aineiden kanssa kosketuksissa olleita tuotteita laitteeseen, laitteen päälle tai sen lähelle.
- Älä jaa Wi-Fi-salasaasi muille.

**VAROITUS!**

Laite voi muutoin vaurioitua.

- Estä emalipinnan vaurioituminen tai haalistuminen:
 - Älä aseta ruoanlaittovälineitä tai muita esineitä laitteeseen siten, että ne olisivat suorassa kosketuksessa laitteen pohjan kanssa.
 - Älä aseta alumiinifoliota siten, että se olisi suorassa kosketuksessa laitteen pohjan kanssa.
 - Älä laita vettä suoraan kuumaan laitteeseen.
 - Älä säilytä kosteita astioita tai ruokia laitteessa lopetettuasi ruoanlaiton.
 - Noudata varovaisuutta poistaessasi tai asentaessasi lisäosia.
- Uunin emalipintojen tai ruostumattoman teräksen värimuutokset eivät vaikuta laitteen toimintaan.
- Käytä syvää pannua kosteita kakkuja paistaessasi. Hedelmämehut voivat jättää pysyviä tahroja.
- Laitteen luukku on pidettävä suljettuna käytön aikana.
- Jos laite asennetaan kalusteen paneelin (esim. oven) taakse, ovea ei saa koskaan sulkea laitteen ollessa toiminnassa. Lämpöä tai kosteutta voi kertyä suljetun kalusteen paneelin taakse ja laite, kalusteet tai lattia voivat sen seurauksena vaurioitua. Älä sulje kalusteen paneelia ennen kuin laite on täysin jäähtynyt käytön jälkeen.

2.4 Hoito ja puhdistus

**VAROITUS!**

Ne voivat aiheuttaa henkilövahinkoja, tulipaloja tai laitteen vaurioitumisen.

- Kytke laite pois toiminnasta ja irrota pistoke pistorasiasta ennen ylläpitotoimien aloittamista.
- Tarkista, että laite on kylmä. Vaarana on lasilevyjen rikkoutuminen.
- Vaihda välittömästi vaurioituneet luukun lasipaneelit. Ota yhteyttä valtuutettuun huoltoliikkeeseen.
- Ole varovainen irrottaessasi luukkuja. Luukku on painava!
- Puhdista laite säännöllisesti, jotta pintamateriaali ei vaurioidu.
- Puhdista laite kostealla pehmeällä liinalla. Käytä ainoastaan mietoja pesuaineita. Älä käytä hankausainetta, hankaavia pesulappuja, liuottimia tai metalliesineitä.
- Jos käytät uuninpuhdistussuihketta, noudata tuotepakkauksessa olevia turvallisuusohjeita.

2.5 Pyrolyttinen puhdistus

**VAROITUS!**

Henkilövahinkojen / tulipalon / kemiallisten päästöjen (höyryt) vaara pyrolyysitoiminnassa.

- Ennen pyrolyttisen puhdistamisen ja esilämmityksen käynnistämistä, poista seuraavat uunin sisätilasta:
 - mahdolliset ruokajäämät, öljy- tai rasvaroisheet/-jäämät.
 - mahdolliset irrotettavat varusteet (mukaan lukien laitteen mukana toimitetut ritilät, kiskot jne.) erityisesti tarttumattomat kattilat, pannut, leivinpellit, välineet jne.
- Lue huolella pyrolyttistä puhdistusta koskevat ohjeet.
- Pidä lapset poissa laitteen luota silloin, kun pyrolyttinen puhdistus on käynnissä. Laite kuumenee hyvin voimakkaasti ja kuumaa ilmaa poistuu etupuolella olevista jäähdytysaukoista.

- Pyrolyyttinen puhdistus on korkeassa lämpötilassa tapahtuva toimenpide, jonka aikana voi vapautua höyryjä ruoanlaittojäämistä ja rakennemateriaaleista, ja siksi käyttäjää suositellaan voimakkaasti toimimaan seuraavasti:
 - järjestämään hyvä tuuletus pyrolyyttisen puhdistuksen aikana ja sen jälkeen.
 - järjestämään hyvä ilmanvaihto esilämmityksen aikana ja sen jälkeen.
- Älä läikytä vettä uunin luukulle pyrolyyttisen puhdistuksen aikana ja sen jälkeen, jotta lasipaneelit eivät vahingoitu.
- Yllä kuvatut pyrolyyttisistä uuneista / ruokajäämistä muodostuvat höyryt eivät ole haitallisia ihmisille. Tämä koskee myös lapsia ja heikkokuntoisia henkilöitä.
- Pidä lemmikkieläimet loitolla laitteesta pyrolyyttisen puhdistamisen ja esilämmityksen aikana ja sen jälkeen. Pienet lemmikkieläimet (erityisesti linnut ja matelijat) voivat olla erittäin herkkiä lämpötilanmuutoksille ja laitteesta poistuville höyryille.
- Kaikkien pyrolyyttisten uunien korkeassa lämpötilassa tapahtuva pyrolyyttinen puhdistus voi vaurioittaa kattiloiden, pannujen, leivinpeltien, ruokailuvälineiden jne. tarttumattomia pintoja, ja niistä voi myös muodostua alhaisen tason haitallisia höyryjä.

2.6 Sisävalaistus



VAROITUS!

Sähköiskun vaara.

- Lisätietoa tämän tuotteen sisällä olevista lampuista sekä erikseen myytävistä varalampuista: Kyseiset lamput on suunniteltu kestäämään kodinkoneissa vaativia fyysisiä olosuhteita (esim. lämpötila, värinä, kosteus) tai ne antavat tietoa laitteen toimintatilasta. Niitä ei ole tarkoitettu muihin käyttötarkoituksiin eivätkä ne sovi huoneiden valaisemiseen.
- Tämä tuote sisältää valonlähteen, jonka energiatehokkuusluokka on G.
- Käytä ainoastaan ominaisuuksiltaan samanlaisia lampuja.

2.7 Huolto

- Laitteen korjaukseen liittyvissä asioissa tulee ottaa yhteyttä valtuutettuun huoltopalveluun.
- Ainoastaan alkuperäisiä varaosia saa käyttää.

2.8 Hävittäminen



VAROITUS!

Henkilövahinko- tai tukehtumisvaara.

- Kysy tietoja laitteen oikeaoppisesta hävittämisestä paikalliselta viranomaiselta.
- Irrota pistoke pistorasiasta.
- Leikkaa virtajohto laitteen läheltä ja hävitä se.
- Poista luukun lukitus, jotta lapset, tai lemmikit eivät jäisi loukkuun laitteen sisälle.

3. TUOTEKUVAUS

3.1 Yleiskatsaus

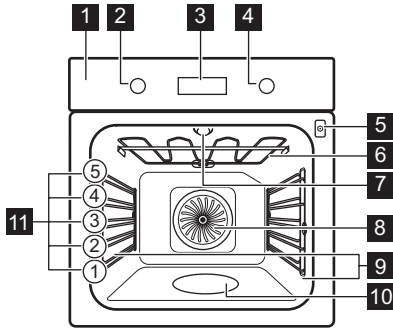

- 1 Käyttöpaneeli
- 2 Uunitoimintojen kierto-nuppi
- 3 Näyttö
- 4 Säätonuppi
- 5 Paistolämpömittarin pistorasia
- 6 Lämpövastus
- 7 Lamppu
- 8 Puhallin
- 9 Hyllykannatin, irrotettava
- 10 Lokero
- 11 Hyllytasot

3.2 Varusteet

Paistoritilä

Ruoanlaittovälineille, kakkuvuokat, paistit.

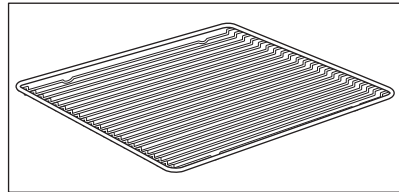

Leivinpelti

Kakuille ja kekseille.

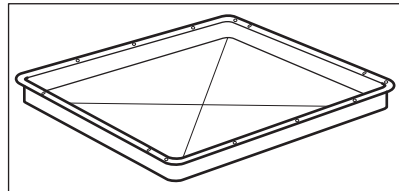

Grilli / uunipannu

Paistamiseen tai pannuna rasvan keräämiseen.

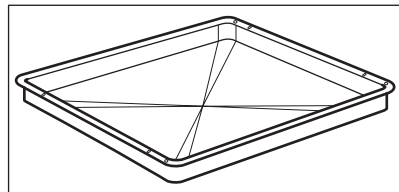

Ammattilaispelti

Käytetään sämpylöiden ja muiden pienten leivonnaisten paistamiseen. Soveltuu höyrytystoimintoihin. Pinnan värimuutokset eivät vaikuta toimintoihin.

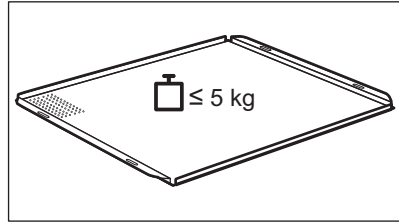

Paistolämpömittari

Ruoan sisälämpötilan mittaamiseen.

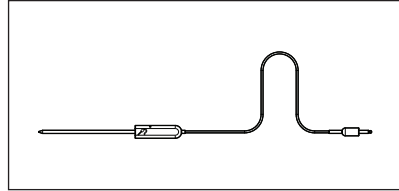

4. KÄYTTÖPANEELI

4.1 Sisäänpainettava vääntimet

Paina väännintä käyttäaksesi laitetta. Väännin tulee ulos.

4.2 Ohjauspaneelin yleisnäkymä















				OK		
Ajastin	Pikakuu- mennus	Uuni- valo	Paistoläm- pömittari	Vahvista asetus	Paina	Kierrä nuppiva- litsinta
Kytke laite päälle valitsemalla uunitoiminto.						
Kytke laite pois päältä kääntämällä uunitoimintojen nappivalitsin Off (pois päältä) -asentoon.						

4.3 Näyttö

	Näyttö, jossa tärkeimmät toiminnot.
--	-------------------------------------

ENNEN ENSIKÄYTTÖÄ

Näytön merkkivalot

Perusmerkkivalot				
 Lukko	 Avustava ruoanvalmistus	 Puhdistus	 Asetukset	 Pikakuumennus
Ajastimen merkkivalot				
 Hälytinajastin	 STOP Lopetus	 Ajastin	 Ajastin	
 Wi-Fi-yhteys -yhteys on kytketty päälle.		 Etäohjaus on kytketty toimintaan.		
Wi-Fi-yhteys merkkivalo – vilkkuu, kun laitteeseen voidaan muodostaa Wi-Fi-yhteys.		Etäohjaus merkkivalo – laitetta voidaan etäohjata.		
Edistymistä osoittava palkki – lämpötilan tai ajan kulumisen seuraamiseen. Kun laite saavuttaa asetetun lämpötilan, osoitinpalkki on kokonaan punainen.				
Höyrykypsentämisen merkkivalo				
Paistolämpömittari merkkivalo				

5. ENNEN ENSIKÄYTTÖÄ



VAROITUS!

Lue turvallisuutta koskevat luvut.

5.1 Alkupuhdistus



Ennen ensikäyttöä tyhjä laite täytyy puhdistaa ja sen kelloon on asetettava seuraava arvo:

			 00:00 Aseta aika. Paina OK.
---	---	---	--

5.2 Alustava esikuumennus



Esikuumenna tyhjä uuni ennen ensimmäistä käyttökertaa.

1. vaihe	Poista kaikki lisävarusteet ja irrotettavat uunipeltien kannattimet uunista.
2. vaihe	Aseta toiminnon maksimilämpötila:  Anna uunin käydä yhden tunnin ajan.
3. vaihe	Aseta toiminnon maksimilämpötila:  Anna uunin käydä 15 minuutin ajan.
<p> Uunista voi tulla hajua ja savua esikuumennuksen aikana. Varmista tilan hyvä tuuletus.</p>	

5.3 Langaton yhteys

Laitteen yhdistämiseen tarvitaan seuraavat asiat:

- langattoman verkon Internet-yhteydellä
- samaan langattomaan verkkoon yhdistetyn mobiililaitteen

1. vaihe	Lataa My Electrolux Kitchen -sovellus: Skannaava arvokilvessä oleva QR-koodi mobiililaitteesi kameralla, jolloin sinut ohjataan Electroluxin verkkosivuille. Arvokilpi löytyy laitteen sisätilan etukehyksestä. Voit myös ladata sovelluksen suoraan sovelluskaupasta.
2. vaihe	Noudata sovelluksen perehdytysohjeita.
3. vaihe	Uunitoimintojen kiertonuppia kääntämällä voit valita:  :
4. vaihe	Säätönuppia kääntämällä voit valita: Asetukset. Kytke päälle Wi-Fi-yhteys. Katso luku "Valikkorakenne".

Taajuus	2,4 GHz WLAN
	2400 - 2483,5 MHz
Protokolla	IEEE 802.11b DSSS/802.11g/n OFDM
Enimmäisteho	EIRP < 20 dBm (100 mW)
Wi-Fi-moduuli	NIUS-50

5.4 Ohjelmistolisenssit

Tämän tuotteen ohjelmisto sisältää komponentteja, jotka perustuvat ilmaisohjelmistoihin ja avoimen lähdekoodin ohjelmistoihin. Electrolux kiitollisena ilmoittaa, että kehittämisprojektissa on käytetty avoimen lähdekoodin ohjelmistoja ja robotiikkayhteisöjen osallistumista. Jos haluat käyttää näiden ilmaisten ja avoimen lähdekoodin ohjelmistojen komponentteja, joiden käyttöoikeusehdot edellyttävät julkaisemista, ja nähdä kaikki ao. tekijänoikeustiedot ja sovellettavat käyttöoikeusehdot, vieraile sivustoilla: <http://electrolux.opensoftwarerepository.com> (kansio NIUS).

6. PÄIVITTÄINEN KÄYTTÖ



VAROITUS!





Lue turvallisuutta koskevat luvut.

6.1 Asetukset: Uunitoiminnot

1. vaihe	Valitse uunitoiminto kääntämällä uunin toimintojen kiertonuppia.
2. vaihe	Aseta lämpötila kääntämällä säätönuppia.
	- paina ja pidä painettuna kytkeäksesi päälle toiminnon: Pikakuumennus. Se on käytettävissä vain joidenkin uunitoimintojen yhteydessä.

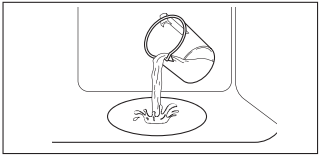
Höyrykypsennys







Varmista, että laite on jäähtynyt.



1. vaihe	2. vaihe	3. vaihe	4. vaihe
			Esikuumenna tyhjää uunia 10 minuuttia kosteuden muodostamiseksi. Aseta ruoka-aineet uuniin.
Täytä lokero hanavedellä.	Valitse höyryuunitoiminto.	Aseta lämpötila.	
 Lokeron enimmäistilavuus on 250 ml. Lokeroon ei saa lisätä vettä käytön aikana tai uunin ollessa kuuma.			

Kun höyrykypsennys päättyy:

1. vaihe	2. vaihe	3. vaihe
Kytke uunin virta pois päältä kääntämällä uunitoimintojen nappivalitsin Off (virta pois päältä) -asentoon.	Avaa luukku kokonaan varovasti. Laitteesta purkautuva kosteus voi aiheuttaa palovammoja.	Varmista, että laite on jäähtynyt. Poista lokeroon jäänyt vesi.

6.2 Uunitoiminnot

Uunitoiminto	Käyttökohde
 Kiertoilma	Korkeintaan kolmella kannatintasolla kypsentäminen samanaikaisesti ja ruokien kuivaus. Aseta lämpötila 20–40 °C alhaisemmaksi kuin toiminnolle Ylä + alalämpö.
 Ylä + alalämpö	Kypsentäminen ja paistaminen yhdellä tasolla.
 SteamBake	Kosteuden lisääminen paistamisen aikana. Oikean värin ja rapean pinnan saavuttaminen paistamisen aikana. Mehukkuuden lisääminen uudelleen lämmityksen aikana. Hedelmien ja vihannesten säilöntään.
 Pizza-toiminto	Pizzan valmistaminen. Voimakkaaseen ruskistamiseen ja rapean pohjan luomiseen.
 Alalämpö	Kakkujen paistamiseksi rapealla pohjalla ja ruoan säilömiseksi.
 Pakasteet	Puolivalmisteruokien (esim. ranskalaisten perunoiden, lohkoperunoiden, kevätkääryleiden) valmistaminen rapeiksi.
 Kosteaa kiertoilma	Tämä toiminto säästää energiaa ruoanlaiton aikana. Kun käytät tätä toimintoa, uunin sisälämpötila voi poiketa lämpötila-asetuksesta. Jälkilämpötilaa käytetään. Kuumennusteho voi laskea. Katso lisätietoa luvusta ”Päivittäinen käyttö”, Huomautus: Kosteaa kiertoilma:

Uunitoiminto	Käyttökohde
 <p>Grilli</p>	Ohuiden ruokien grillaus ja leivän paahtaminen.
 <p>Tehogrillaus</p>	Isohkojen, luisten liha- tai lintupaistien paistamiseen yhdessä ritiläasennossa. Gratinointi ja ruskistus.
 <p>Valikko</p>	Siirtyminen valikkoon: Avustava ruoanvalmistus, Puhdistus, Asetukset.

i Kiertoilma, Ylä + alalämpö: Kun lämpötila on asetettu alle 80 °C:seen, lamppu sammuu automaattisesti 30 sekunnin kuluttua.

6.3 Huomautus: Kosteä kiertoilma

Tämän toiminnon avulla määritettiin energiatehokkuusluokka (vastaamaan standardeja EU 65/2014 ja EU 66/2014). Testit seuraavan mukaisesti: IEC/EN 60350-1

Uunin luukun on oltava kiinni ruoanlaiton aikana, jotta toiminto ei keskeytyisi ja uunin energiatehokkuus olisi mahdollisimman suuri.





Kun valitset tämän toiminnon, lamppu sammuu automaattisesti 30 sekunnin kuluttua. Ruoanlaitto-ohjeet ovat luvussa "Neuvoja ja vinkkejä" Kosteä kiertoilma. Yleissuosituksia energiansäästämiseksi on luvussa "Energiatehokkuus".

6.4 Asetukset: Avustava ruoanvalmistus





Tämän alavalikon kaikki ruokalajit sisältävät uunitoiminto- ja lämpötilasuosituksen. Käytä toimintoa ruoan nopeaan valmistamiseen oletusasetuksilla. Voit myös säätää aikaa ja lämpötilaa kypsytämisen aikana.

Joidenkin ruokalajien kohdalla voit valita myös seuraavaa:	Ruoan kypsyytaso:
<ul style="list-style-type: none"> Paistolämpömittari 	<ul style="list-style-type: none"> Puoliraaka Keskitaso Kypsä



1. vaihe	2. vaihe	3. vaihe	4. vaihe
----------	----------	----------	----------







 ☰	 ✂	 P1 - P45	 OK
Siirry valikkoon.	Valitse Avustava ruoanvalmistus. Paina OK.	Valitse ruokalaji. Paina OK.	Laita ruokalaji uuniin. Vahvista asetus.





















6.5 Avustava ruoanvalmistus

Symbolien selitys	
	Paistolämpömittari saatavana. Aseta Paistolämpömittari paksuimpaan kohtaan. Kun asetettu Paistolämpömittari -osan lämpötila on saavutettu, laite kytkeytyy automaattisesti pois päältä.
	Höyrytoiminnon edellyttämä vesimäärä.
	Esikuumenna laite ennen kypsennyksen aloittamista.
	Hyllytaso.



















Näytössä näkyy **P** ja ruokalajin **numero**, jonka voit tarkistaa taulukosta. Kun toiminto päättyy, tarkista, onko ruoka valmis.

	Ruoka-annos	Paino	Hyllytaso / Lisävaruste
1	Paahtopaisti, raaka	1 - 1.5 kg; 4 - 5 cm paksuudeltaan olevia kappaleita	 ☰ 2; paistopelti Paista lihaa muutama minuutti kuumalla paistinpannalla. Aseta laitteeseen.
2	Paahtopaisti, puolikypsä		
3	Paahtopaisti, kypsä		
4	Pihvi, puolikypsä	180 - 220 g per kappale; siivut 3 cm paksuudeltaan	 ☰ ☰ 3; paistettava ruoka paistoritilällä Paista lihaa muutama minuutti kuumalla paistinpannalla. Aseta laitteeseen.

	Ruoka-annos	Paino	Hyllytaso / Lisävaruste
5	Naudanlihapaisti / haudutettu (ensiluokkainen kylkipaisti, paras pyöreä, paksu kylki)	1.5 - 2 kg	 2; paistettava ruoka on paistoritilällä Paista lihaa muutama minuutti kuumalla paistinpannalla. Lisää nestettä. Aseta laitteeseen.
6	Paahtopaisti, raaka (hidas kypsennys)	1 - 1.5 kg; 4 - 5 cm paksuudeltaan olevia kappaleita	 2; leivinpelti Ota käyttöön suosikkireseptesi tai käytä pelkästään suolaa ja juuri hienonnettua pippuria. Paista lihaa muutama minuutti kuumalla paistinpannalla. Aseta laitteeseen.
7	Paahtopaisti, puolikypsä (hidas kypsennys)		
8	Paahtopaisti, kypsä (hidas kypsennys)		
9	Filee, raaka (hidas kypsennys)	0,5 - 1,5 kg; 5 - 6 cm paksuudeltaan olevia kappaleita	 2; paistopelti Ota käyttöön suosikkireseptesi tai käytä pelkästään suolaa ja juuri hienonnettua pippuria. Paista lihaa muutama minuutti kuumalla paistinpannalla. Aseta laitteeseen.
10	Filee, puolikypsä (hidas kypsennys)		
11	Filee, kypsä (hidas kypsennys)		
12	Vasikanlihapaah- topaisti (esim. lapa)	0.8 - 1.5 kg; 4 cm paksuudeltaan olevia kappaleita	 2; paistettava ruoka on paistoritilällä Käytä suosikkimausteitasi. Lisää nestettä. Paisti peitetty.
13	Porsaanpaisti, niska tai lapa	1.5 - 2 kg	 2; paistettava ruoka paistoritilällä Käännä liha kypsennyksen puolivälissä.
14	Pulled pork (matalalämpö)	1.5 - 2 kg	 2; paistopelti Käytä suosikkimausteitasi. Käännä liha, kun noin puolet kypsennysajasta on kulunut, jotta ruskistus olisi tasainen.
15	Kylki, tuore	1 - 1.5 kg; 5 - 6 cm paksuudeltaan olevia kappaleita	 2; paistovuoka paistoritilällä Käytä suosikkimausteitasi.

	Ruoka-annos	Paino	Hyllytaso / Lisävaruste
16	Siankylki	2 - 3 kg; käytä raakana, 2 - 3 cm ohuita siankylkiä	 3; syvä pannu Lisää nestettä peittämään astian pohjan. Käännä liha kypsennyksen puolivälissä.
17	Lampaankoipi luineen	1.5 - 2 kg; 7 - 9 cm paksuudeltaan olevia kappaleita	  2; paistovuoka leivinpellillä Lisää nestettä. Käännä liha kypsennyksen puolivälissä.
18	Kana, kokonainen	1 - 1.5 kg; tuoreena	  2;  200 ml; pataruoka-astia paistolevyllä Käytä suosikkimausteitasi. Käännä kana, kun noin puolet kypsennysajasta on kulunut, jotta ruskistus olisi tasainen.
19	Kana, puolikas	0.5 - 0.8 kg	  3; paistopelti Käytä suosikkimausteitasi.
20	Kanan rintafilee	180 - 200 g kappaletta kohti	  2; pataruoka-astia paistoritilällä Käytä suosikkimausteitasi. Paista lihaa muutama minuutti kuumalla paistinpannulla.
21	Kanan koivet, tuoreet	-	  3; paistopelti Jos olet ensin marinoidut kanankoivet, aseta matalampi lämpötila ja kypsennä pidempään.
22	Kokonainen ankka	2 - 3 kg	  2; paistettava ruoka on paistoritilällä Käytä suosikkimausteitasi. Aseta liha paistoastiaan. Käännä ankka kypsennyksen puolivälissä.
23	Kokonainen hanhi	4 - 5 kg	  2; syvä pannu Käytä suosikkimausteitasi. Aseta liha syvälle paistopellille. Käännä hanhi kypsennyksen puolivälissä.
24	Lihamureke	1 kg	  2; paistoritilä Käytä suosikkimausteitasi.
25	Kokonainen kala, grillattu	0.5 - 1 kg kalaa kohti	  2; paistopelti Täytä kala voilla ja ota käyttöön suosikkimausteisi.

PÄIVITTÄINEN KÄYTTÖ

	Ruoka-annos	Paino	Hyllytaso / Lisävaruste
26	Kalafilee	-	 3 ; pataruoka-astia paistoritilällä Käytä suosikkimausteitasi.
27	Juustokakku	-	 2 ;  28 cm irtopohjavuoka paistoritilällä
28	Omenakakku	-	 2 ;  100–150 ml; leivinpelti
29	Omenatorttu	-	 2 ; piirakkavuoka paistoritilällä
30	Omenapiirakka	-	 2 ;  100–150 ml;  22 cm piirakka- muotti paistoritilällä
31	Brownie	2 kg taikinaa	 3 ; syvä pannu
32	Suklaamuffinit	-	 2 ;  100–150 ml; muffinipelti paistoritilällä
33	Murekekakku	-	 2 ; leipävuoka paistoritilällä
34	Paistetut perunat	1 kg	 2 ; leivinpelti Laita kokonaiset kuorelliset perunat paistopelleille.
35	Lohkoperunat	1 kg	 3 ; paistopelti katettu leivinpaperilla Käytä suosikkimausteitasi. Leikkaa perunat loh- koiksi.
36	Grillatut sekavi- hannekset	1 - 1.5 kg	 3 ; paistopelti katettu leivinpaperilla Käytä suosikkimausteitasi. Leikkaa vihannekset paloiksi.
37	Kuorukat, pakas- te	0.5 kg	 3 ; paistopelti
38	Omenat, pakaste	0.75 kg	 3 ; leivinpelti
39	Liha-/kasvisla- sagne keittämät- tömistä lasagne- levyistä	1 - 1.5 kg	 2 ; nuudeliannos paistoritilällä



	Ruoka-annos	Paino	Hyllytaso / Lisävaruste
40	Perunapaistos (raa'asta perunas- ta)	1 - 1.5 kg	1; nuudeliannos paistoritilällä Käännä vuoka kypsennyksen puolivälissä.
41	Pizza tuore, ohut	-	2; 100 ml; paistopelti leivinpaperilla katettu
42	Pizza tuore, pak- su	-	2; leivinpelti , jossa päällä leivinpaperi
43	Piirakka	-	2; paistovuoka paistoritilällä
44	Patonki / Ciabat- ta / Vaalea leipä	0.8 kg	2; 150 ml; paistopelti leivinpaperilla katettu Vaalea leipä vaatii enemmän aikaa.
45	Kokojyvä / Ruis / Tumma leipä ko- kojyväleipää limppupannulla	1 kg	2; 150 ml; leivinpelti leivinpaperilla katettu / paistoritilällä







7. KELLOTOIMINNOT







7.1 Kellotoiminnot

Kellotoiminto	Käyttökohde
 Hälytinajastin	Kun ajastin saavuttaa loppupisteen, laitteesta kuuluu äänimerkki.
 Kypsentämisaika	Kun ajastin saavuttaa loppupisteen, laitteesta kuuluu äänimerkki ja uunitoiminto pysähtyy.
 Ajastin	Toiminnon käynnistymisen ja/tai päättymisen ajastus.
 Ajastin	Enintään 23 tuntia 59 min. Tällä toiminnolla ei ole vaikutusta uunin käyttöön. Voit kääntää toiminnon Ajastin päälle ja pois päältä valitsemalla: Valikko, Asetukset.

7.2 Asetukset: Kellotoiminnot





Asetukset: Kellonaika		
1. vaihe	2. vaihe	3. vaihe
		
Jos haluat vaihtaa kellonajan, siirry valikkoon ja valitse Asetukset, Kellonaika.	Aseta kellonaika.	Paina: OK.

Asetukset: Hälytinajastin			
1. vaihe	Näytössä näkyy: 0:00 	2. vaihe	3. vaihe
			
Paina: 		Aseta Hälytinajastin	Paina: OK.
 Ajastin käynnistyy välittömästi.			

Asetukset: Kypsentämisaika				
1. vaihe	2. vaihe	Näytössä näkyy: 0:00  STOP	3. vaihe	4. vaihe
				
Valitse uunitoiminto ja aseta lämpötila.	Paina toistuvasti: 		Kypsennysaika on asetettu.	Paina: OK.
 Ajastin käynnistyy välittömästi.				

LISÄVARUSTEIDEN KÄYTTÄMINEN

Asetukset: Ajastin

1. vaihe	2. vaihe		3. vaihe	4. vaihe		5. vaihe	6. vaihe
		Näytössä näkyy kellonaika 			Näytössä näkyy: --:--  PY-SÄYTÄ		
Valitse uunitoiminto.	Paina toistuvasti: 	KÄYNNISTÄ	Aseta käynnistysaika.	Paina: OK.		Aseta pysäytysaika.	Paina: OK.

 Ajastin aloittaa ajanlaskennan asetettuna käynnistysaikana.

8. LISÄVARUSTEIDEN KÄYTTÄMINEN



VAROITUS!

Lue turvallisuutta koskevat luvut.

8.1 Lisävarusteiden asennus

Pieni lovi yläosassa parantaa turvallisuutta. Nämä lovet toimivat myös kaatumisen estämisessä. Ritilän korkea reunus estää keittoastioiden luisumisen hyllyltä.

Paistoritilä:

Paina ritilä liukukiskoja väliin kannatinkokoon .

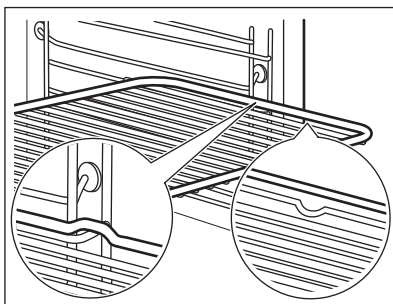

Leivinpelti / Syvä pannu:

Työnnä leivinpelti hyllykannattimen ohjaukiskojojen väliin.

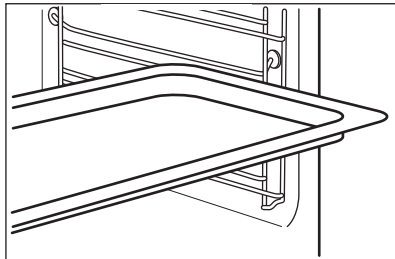

8.2 Paistolämpömittari

Paistolämpömittari – mittaa ruoan sisälämpötilan.

Asetettavia lämpötiloja on kaksi:

°C
Uunin lämpötila.

Sisälämpötila.

Näin saavutat parhaan kypsennystuloksen



Ainesosien pitäisi olla huoneenlämpöisiä.

Älä käytä nestemäisten ruokien suhteen.

Mittari on jätettävä ruokaan kypsennyksen ajaksi.

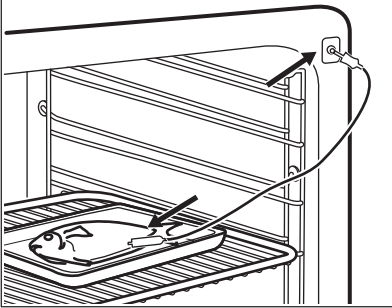
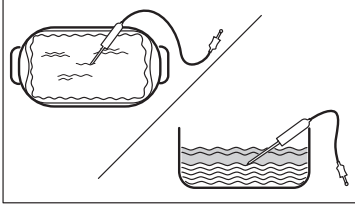

Käyttöohje: Paistolämpömittari

1. vaihe	Kytke uuni päälle.
2. vaihe	Valitse uunitoiminto ja tarvittaessa uunin lämpötila.
3. vaihe	Lisää: Paistolämpömittari.
Liha-, lintu- ja kalaruoka	Vuokaruoka
Aseta Paistolämpömittari kärki lihan tai kalan keskelle paksuimpaan kohtaan, jos mahdollista. Varmista, että vähintään 3/4 Paistolämpömittari on ruoan sisällä.	Aseta Paistolämpömittari kärki tarkalleen vuokaruuan keskelle. Paistolämpömittari tulee asettaa vakaasti paikalleen yhteen kohtaan kypsennyksen ajaksi. Käytä sen vakauttamiseen kiinteää ruoka-ainesta. Käytä paistoastian reunaa tukemaan Paistolämpömittari silikonista valmistettua kädensijaa. Paistolämpömittari -kärki ei saa koskettaa paistoastian pohjaa.

	
<p>4. vaihe</p>	<p>Liitä Paistolämpömittari laitteen etukehyksessä olevaan pistorasiaan. Senhetkinen lämpötila näkyy näytössä: Paistolämpömittari.</p>
<p>5. vaihe</p>	<p> - aseta paistolämpömittarin lämpötila painamalla.</p>
<p>6. vaihe</p>	<p>OK – paina vahvistaaksesi. Kun ruoka on kuumentunut asetettuun lämpötilaan, laitteesta kuuluu äänimerkki. Voit halutessasi lopettaa kypsennyksen tai jatkaa sitä ruoan oikean kypsyyden varmistamiseksi.</p>
<p>7. vaihe</p>	<p>Irrota Paistolämpömittari pistoke pistorasiasta ja poista ruoka uunista.</p> <div style="border: 1px solid black; padding: 5px; margin-top: 10px;"> <p> VAROITUS! Palovammojen vaara on olemassa, sillä Paistolämpömittari kuumentuu erittäin kuumaksi. Ole varovainen pistokkeen irrottamisen ja mittarin poistamisen aikana.</p> </div>

9. LISÄTOIMINNOT

9.1 Lukko



<p>Tämä toiminto estää toiminnon tahattoman muuttamisen.</p>		
<p>Kytke se päälle, kun laite toimii – valittu ruoanlaitto jatkuu ja ohjauspaneeli on lukittu. Kytke se päälle laitteen ollessa pois päältä – laitetta ei voi nyt kytkeä päälle. Ohjauspaneeli on lukittu.</p>		
	<p>Kytke toiminto päälle painamalla painiketta  OK. Äänimerkki kuuluu.</p>	<p> OK – paina ja pidä painettuna kytkeäksesi sen pois päältä.</p>

Tämä toiminto estää toiminnon tahattoman muuttamisen.

① 3 x  – vilkkuu, kun lukko kytketään päälle.

9.2 Automaattinen virrankatkaisu

Turvallisuussyistä laite kytkeytyy pois päältä jonkin ajan kuluttua, jos jokin uunitoiminto on käynnissä eikä asetuksiin tehdä muutoksia.

 (°C)	 (tunti)
30 - 115	12.5
120 - 195	8.5
200 - 245	5.5
250 – enintään	3

Automaattinen virrankatkaisu ei toimi seuraavien toimintojen kanssa: Uunivalo, Paistolämpömittari, Ajastin.

9.3 Jäähdytyspuhallin

Kun laite on päällä, jäähdytyspuhallin kytkeytyy automaattisesti päälle pitääkseen laitteen pinnat viileinä. Kun kytket laitteen pois päältä, jäähdytyspuhallin on käynnissä, kunnes laite on jäähtynyt.

9.4 Mekaanin luukun lukko

Luukun lukitus on auki uunin ostaessasi.

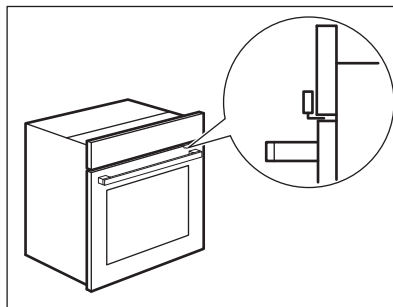

<p>⚠ HUOMIO! Älä siirrä luukun lukkoa pystysuunnassa. Älä työnnä luukun lukkoa uunin luukkua sulkiessasi.</p>	
--	--

9.5 Käyttöohje: Mekaanin luukun lukko

<p>1. vaihe</p>	<p>Lukitse lukku vetämällä luukun lukitusta eteenpäin, kunnes se lukkiutuu.</p>
<p>2. vaihe</p>	<p>Avaa lukku painamalla luukun lukitus takaisin paneeliin.</p>

Lukitun luukun avaaminen

<p>Luukku voidaan avata, kun luukun lukitus on päällä.</p>	
<p>1. vaihe</p>	<p>Paina luukun lukitusta kevyesti ja avaa luukku vetämällä sitä kahvasta.</p>
<p>Varmista luukkua sulkiessasi, että luukun lukitus pysyy kiinni.</p>	

10. VIHJEITÄ JA NEUVOJA



10.1 Ruoanlaittoon liittyviä suosituksia



Taulukoissa mainitut lämpötilat ja paistoajat ovat ainoastaan suuntaa-antavia. Optimaalinen aika ja lämpötila riippuvat reseptistä ja käytettyjen aineiden laadusta ja määrästä. Laitteesi voi paistaa eri tavalla kuin entinen laitteesi. Alla olevat vinkit sisältävät suositellut lämpötilat, kypsennysajat ja kannatintasot eri ruokalajeille. Jos taulukosta ei löydy reseptiisi sopivia asetuksia, voit soveltaa jonkin samantyyppisen paistoksen asetuksia.



10.2 Kosteaa kiertoilmaa

Noudata alla olevan taulukon ehdotuksia parhaan tuloksen saavuttamiseksi. Käytä kolmatta kannatintasoa.

	 (°C)	 (min)
Pastagratiini	200 - 220	45 - 55
Perunapaistos	180 - 200	70 - 85
Moussaka	170 - 190	70 - 95
Lasagne	180 - 200	75 - 90
Cannelloni	180 - 200	70 - 85
Leipävanukas	190 - 200	55 - 70
Riisivanukas	170 - 190	45 - 60
Omenakakku vatkatusta taikinasta (pyöreä kakkuvuoka)	160 - 170	70 - 80
Vaalea leipä	190 - 200	55 - 70

10.3 Kosteaa kiertoilmaa – suositellut varusteet

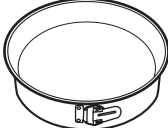
Käytä tummia heijastamattomia vuokia ja astioita. Ne absorboivat enemmän lämpöä vaaleisiin ja heijastaviin astioihin verrattuna.





			
Pizzapannu	Uunivuoka	Annosvuokat	Torttuvuoka
Tumma, heijastamaton 28 cm halkaisija	Tumma, heijastamaton 26 cm halkaisija	Keramiikka halkaisija 8 cm, korkeus 5 cm	Tumma, heijastama- ton 28 cm halkaisija

10.4 Testilaitosten ruoanvalmistustaulukot

Tiedoksi testauslaitoksille

Testit seuraavan mukaisesti: EN 60350, IEC 60350.





Paistaminen yhdellä tasolla – vuossa

		 °C	 min	
Rasvaton sokerikakku	Kiertoilma	160	45 - 60	2
Rasvaton sokerikakku	Ylä + alalämpö	160	45 - 60	2
Omenapiirakka, 2 vuokaa Ø20 cm	Kiertoilma	160	55 - 65	2
Omenapiirakka, 2 vuokaa Ø20 cm	Ylä + alalämpö	180	55 - 65	1
Murokeksit	Kiertoilma	140	25 - 35	2
Murokeksit	Ylä + alalämpö	140	25 - 35	2





Paistaminen yhdellä tasolla – pikkuleivät

Käytä kolmatta hyllytasoa.

VIHJEITÄ JA NEUVOJA

		 °C	 min
Pienet kakut (20 kpl/leivinpelti), esikuumenna tyhjä uuni	Kiertoilma	150	20 - 30
Pienet kakut (20 kpl/leivinpelti), esikuumenna tyhjä uuni	Ylä + alalämpö	170	20 - 30





Paistaminen usealla tasolla – pikkuleivät

		 °C	 min	
Murokeksit	Kiertoilma	140	25 - 45	2 / 4
Pienet kakut (20 kpl/leivinpelti), esikuumenna tyhjä uuni	Kiertoilma	150	25 - 35	1 / 4
Rasvaton sokerikakku	Kiertoilma	160	45 - 55	2 / 4
Omenapiirakka, 1 vuoka ritilää kohden (Ø 20 cm)	Kiertoilma	160	55 - 65	2 / 4

Grilli

Esikuumenna tyhjää uunia 5 minuutin ajan.

Grillaa lämpötilan suurimmalla asetuksella.

		 min	
Paahtoleipä	Grilli	1 - 2	5
Naudanlihapihvi, käännä kypsennyksen puolivälissä	Grilli	24 - 30	4

11. HOITO JA PUHDISTUS





VAROITUS!

Lue turvallisuutta koskevat luvut.

11.1 Puhdistukseen liittyviä huomautuksia

 <p>Puhdistusai- neet</p>	Puhdista laitteen etuosa pelkällä lämpimällä vedellä ja miedolla pesuaineella mikrokuituliinaa käyttäen.
	Puhdista metallipinnat puhdistusaineella.
	Poista tahrat miedolla pesuaineella.

 <p>Jokapäiväi- nen käyttö</p>	Puhdista uunin sisäosa jokaisen käytön jälkeen. Rasvan tai muiden jäämien kertyminen saattaa aiheuttaa tulipalon.
	Älä jätä ruokia laitteeseen 20 minuuttia pidemmäksi ajaksi. Kuivaa sisäosa pelkällä mikrokuituliinalla jokaisen käyttökerran jälkeen.

 <p>Tarvikkeet</p>	Puhdista kaikki varusteet jokaisen käytön jälkeen ja anna niiden kuivua. Käytä pelkästään mikrokuituliinaa, lämmintä vettä ja mietoä puhdistusainetta. Varusteita ei saa pestä astianpesukoneessa.
	Tarttumattomia lisävarusteita ei saa puhdistaa hankaavilla puhdistusaineilla tai teräväreunaisilla esineillä.

11.2 Puhdistaminen: Lokeron reliefi

Poista kalkkijäämät puhdistamalla sisätilan reliefi höyrytoiminnon käyttämisen jälkeen.

1. vaihe	2. vaihe	3. vaihe
Kaada 250 ml valkoviinietikkaa lokeroon. Käytä enintään 6 % viinietikkaa ilman lisäaineita.	Anna viinietikan liuottaa kalkkijäämiä ympäröivässä lämpötilassa 30 minuutin ajan.	Puhdista uunitila pehmeällä liinalla.

Toimintoa varten: SteamBake puhdista uuni aina 5–10 käyttökerran jälkeen.

11.3 Irrottaminen: Kannattimet

Poista kannattimet uunin puhdistamiseksi.

HOITO JA PUHDISTUS

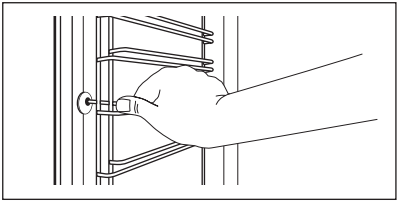
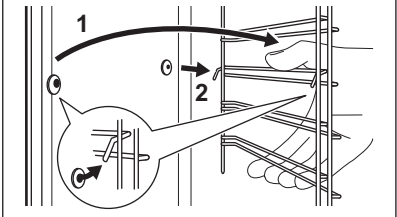
1. vaihe	Kytke uuni pois päältä ja odota, että se jäähtyy.	
2. vaihe	Vedä uunipeltien kannattimen etuosa irti sivuseinästä.	
3. vaihe	Vedä uunipeltien kannatinkiskon takaosa irti sivuseinästä ja poista se.	
4. vaihe	Asenna hyllytuet päinvastaisessa järjestyksessä.	

11.4 Käyttöohje: Pyrolyttinen puhdistus

Puhdista uuni käyttäen Pyrolyttinen puhdistus.



VAROITUS!

On olemassa palovammojen vaara.



HUOMIO!



Jos samaan kaappiin on asennettu muita laitteita, älä käytä niitä samaan aikaan tämän toiminnon kanssa. Se voi vahingoittaa uunia.

Ennen Pyrolyttinen puhdistus:

kytke uuni pois päältä ja odota, että se jäähtyy.	poista kaikki lisävarusteet ja irrotettavat uunipeltien hyllykantimet uunista	Puhdista uunin pohja ja sisempi luukun lasi lämpimällä vedellä ja miedolla pesuaineella ja käyttämällä pehmeää puhdistusliinaa.
---	---	---

Pyrolyttinen puhdistus

1. vaihe	Siirry valikkoon: Puhdistus $\frac{mm}{.}$.	
Vaihtoehto		Kesto
C1 - Kevyt puhdistus		1 h
C2 - Normaali puhdistus		1 h 30 min

Pyrolyyttinen puhdistus	
C3 - Perusteellinen puhdistus	3 h
2. vaihe	OK – paina puhdistustoiminnon valitsemiseksi.
3. vaihe	OK – paina puhdistuksen käynnistämiseksi.
4. vaihe	Suoritettuasi puhdistuksen käännä uunitoimintojen nuppivalitsin Off (pois päältä) -asentoon.
<p> Kun puhdistus käynnistyy, uuninluukku lukittuu ja merkkivalo sammuu. Kunnes luukku kukittuu, näytöllä näkyy: </p>	



Puhdistuksen päätyttyä:		
Kytke uuni pois päältä ja odota, että se jäähtyy.	Puhdista uunitila pehmeällä liinalla.	Poista jäämät uunin pohjasta.

11.5 Muistutus puhdistamisesta

Uuni muistuttaa sinua aina, kun pyrolyyttinen puhdistus on suoritettava.	
 vilkkuu näytöllä 5 sekuntia jokaisen ruoanlaittokerran jälkeen.	Kytke muistutus pois päältä syöttämällä Valikko ja valitsemalla Asetukset, Muistutus puhdistamisesta.

11.6 Irrrottaminen ja asentaminen: Luukku

Voit poistaa luukun ja sisäiset lasilevyt niiden puhdistamiseksi. Lasipaneelien lukumäärä vaihtelee eri malleissa.

	VAROITUS! Luukku on painava.
	HUOMIO! Käsittele lasia varoen, tämä koskee erityisesti etupaneelin reunoja. Lasi voi rikkoontua.

HOITO JA PUHDISTUS

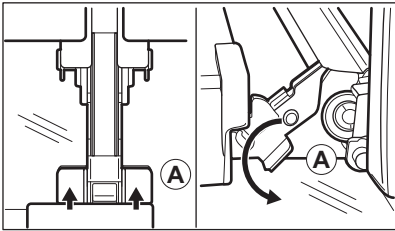
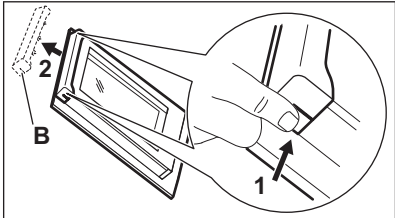
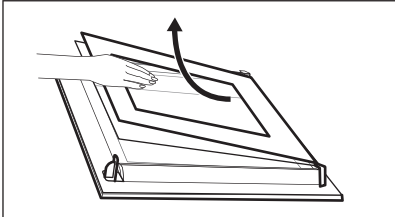
1. vaihe	Avaa luukku kokonaan.	
2. vaihe	Paina ja nosta saranoissa olevat lukitusvivut (A).	
3. vaihe	Sulje uunin luukku ensimmäiseen avausasentoon (likimäärin 70° kulma). Tartu luukkuun kummaltakin puolelta ja vedä se irti uunista ylöspäin suuntautuvassa kullmassa. Aseta luukku sen ulkopinta alaspäin vakaalle pinnalle levitetyn liinan päälle.	
4. vaihe	Pidä kiinni luukun reunalistasta (B) molemmiin puolin luukun yläreunaa ja työnnä sisään vapauttaaksesi pinnetiivisteet.	
5. vaihe	Irrota luukun reunalista vetämällä sitä eteenpäin.	
6. vaihe	Tartu lasilevyihin yläreunasta ja vedä ne yksi kerrallaan ulos kiskoista.	
7. vaihe	Puhdista lasipaneeli vedellä ja saippualla. Kuivaa lasipaneeli huolellisesti. Lasilevyjä ei saa pestä astianpesukoneessa.	
8. vaihe	Suorita edellä kuvatut vaiheet päinvastaisessa järjestyksessä puhdistamisen jälkeen.	
9. vaihe	Kiinnitä ensiksi pienin lasilevy, sitten suurempi ja lopuksi luukku. Varmista, että lasit on asetettu oikeaan asentoon. Muutoin luukun pinta voi ylikuumentua.	

11.7 Vaihtaminen: Lamppu



VAROITUS!

Sähköiskun vaara.
Lamppu voi olla kuuma.

Ennen lampun vaihtamista:		
1. vaihe	2. vaihe	3. vaihe
Kytke uuni pois päältä. Odota, kunnes uuni on jäähtynyt.	Irrota uunin pistoke pistorasiasta.	Peitä uunin pohja kankaalla.

Ylälamppu

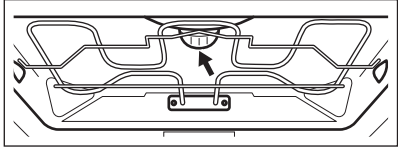
1. vaihe	Irrota suojalasi kiertämällä sitä.	
2. vaihe	Puhdista lampun kansi.	
3. vaihe	Vaihda lamppu sopivaan 300 °C lämmönkestävään lamppuun.	
4. vaihe	Asenna lasinen kansi.	

Sivulamppu

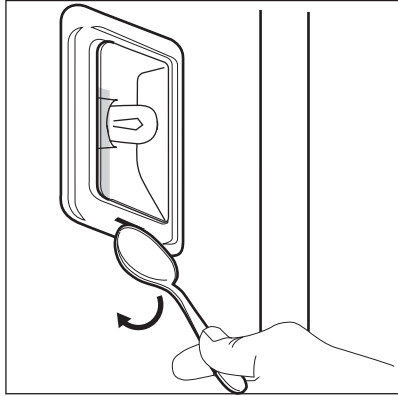
1. vaihe	Irrota vasen ritiläkannatin, jotta pääset käsittelemään lampua.	
2. vaihe	Käytä kapeaa ja tylsää esinettä (esim. teelusikka) lasikuvun irrottamiseen.	
3. vaihe	Puhdista lampun kansi.	
4. vaihe	Vaihda lamppu sopivaan 300 °C lämmönkestävään lamppuun.	
5. vaihe	Asenna lasinen kansi.	
6. vaihe	Asenna vasen ritiläkannatin.	

12. VIANMÄÄRITYS





VAROITUS!

Lue turvallisuutta koskevat luvut.

12.1 Käyttöhäiriöt...

Mikäli laitteessa ilmenevää ongelmaa ei ole kuvattu tässä taulukossa, ota yhteyttä valtuutettuun huoltoliikkeeseen.

 Laite ei käynnisty tai ei kuumene	
Ongelma	Tarkista, jos...
Et saa laitetta käynnistymään tai et voi käyttää sitä.	Laite on yhdistetty asianmukaisesti sähköverkkoon.
Laite ei kuumene.	Automaattinen virrankatkaisu on pois toiminnasta.
Laite ei kuumene.	Laitteen luukku on kiinni.
Laite ei kuumene.	Sulake ei ole palanut.
Laite ei kuumene.	Painikelukitus on poissa päältä.

 Komponentit	
Ongelma	Tarkista, jos...
Lamppu on kytketty pois päältä.	Kostea kiertoilma – on kytketty päälle.
Lamppu ei toimi.	Lamppu on palanut.
Paistolämpömittari ei toimi.	Paistolämpömittari -osan pistoke on liitetty asianmukaisesti pistokkeeseen.

 Virhekoodit	
Näytössä näkyy...	Tarkista, jos...
Err C2	Osan Paistolämpömittari pistoke on irrotettu pistorasiasta.
Err C3	Laitteen luukku on suljettu tai luukun lukko ei ole vaurioitunut.

**Virhekoodit**

Err F102	Laitteen luukku on kiinni.
Err F102	Luukun lukko ei ole vaurioitunut.
00:00	On tapahtunut virtakatko. Aseta kellonaika.
<p>Jos näytössä näkyy jokin muu kuin tässä taulukossa kuvattu virhekoodi, kytke asuinrakennuksen sulake pois päältä ja uudelleen päälle ja käynnistä sitten laite uudelleen. Jos virhekoodi tulee uudelleen näkyviin, ota yhteyttä valtuutettuun huoltopalveluun.</p>	

**Puhdistus**

Ongelma	Tarkista, jos...
Vettä vuotaa uunin lokerosta.	Lokerossa on liikaa vettä.

12.2 Huoltotiedot

Jos et itse löydä ratkaisua ongelmaasi, ota yhteys jälleenmyyjään tai valtuutettuun huoltopalveluun.

Huoltoliikkeen tarvitsemat perustiedot löydät laitteen arvokilvestä. Arvokilpi löytyy laitteen sisätilan etukehyksestä. Älä poista arvokilpeä laitteen sisätilasta.

Suosittelemme, että kirjoita tiedot tähän:

Malli (Mod.):
Tuotenumero (PNC)
Sarjanumero (S.N.)

13. ENERGIATEHOKKUUS**13.1 Tuotetiedot ja tuotteen tietolomake**

Toimittajan nimi	Electrolux
------------------	------------

Mallin tunniste	COP827V 944032113 COP827X 944032112 EO82PBK 944032114	
Energiatehokkuusluokka	81,2	
Energiatehokkuusluokka	A+	
Energiankulutus normaalikäytössä Ylä- ja alalämpö -toiminnossa	1,09 kWh/kierros	
Energiankulutus vakiokuormalla, tuuletintila	0,69 kWh/kierros	
Pesien lukumäärä	1	
Lämpölähde	Sähkö	
Äänimer.voimak	71 l	
Uunityyppi	Kalusteeseen asennettava uuni	
Massa	COP827V	35.0 kg
	COP827X	35.0 kg
	EO82PBK	35.0 kg

IEC/EN 60350-1 – Ruoanlaittoon tarkoitetut sähkötoimiset kodinkoneet – Osa 1: Mallistot, uunit, höyryuunit ja grillit – Menetelmiä tehon mittaukseen.

13.2 Energiansäästö



Laitteessa on joitakin toimintoja, joiden avulla voit säästää energiaa.

Varmista, että laitteen luukku on kiinni laitteen ollessa käynnissä. Älä avaa laitteen luukkua liian usein kypsennyksen aikana. Pidä luukun tiiviste puhtaana ja varmista, että se on hyvin kiinni paikoillaan.

Käytä metallisia keittoastioita energiatehokkuuden parantamiseksi.

Jos vain mahdollista, älä esikuumenna laitetta ennen ruokien asettamista uuniin.

Minimoi paistojen väliset tauot, kun valmistat kerralla useampia ruokia.

Puhallintoiminnon käyttäminen ruoanlaiton yhteydessä

Jos mahdollista, käytä uunitoimintoja puhaltimella energian säästämiseksi.

Jäännöslämpö

Puhaltimen ja lampun toiminta jatkuu. Kun sammutat laitteen, näytössä näkyy jälkilämpö.

Lämmön avulla voit pitää ruoka-aineksia lämpimänä.

Kun kypsennys kestää yli 30 minuuttia, laske laitteen lämpötila alimmalle asetukselle 3–10 minuuttia ennen kypsennysajan päättymistä. Jälkilämpö laitteen sisällä jatkaa ruoka-aineksien kypsentämistä.

Lämmitä muita ruokalajeja jälkilämpöä käyttäen.

Ruoan lämpimänä pitoon

Valitse alhaisin mahdollisin lämpötila-asetus, niin voit hyödyntää jälkilämmön ja säilyttää aterian lämpimänä. Jälkilämmön merkivalo tai lämpötila syttyy näyttöön.

Kypsentäminen lampun ollessa sammutettuna

Kytke lamppu pois päältä kypsennyksen aikana. Kytke se päälle ainoastaan tarvittaessa.







Kostea kiertoilma



Tämä toiminto säästää energiaa ruoanlaiton aikana.

Kun tämä toiminto on käytössä, lamppu sammuu automaattisesti 30 sekunnin kuluttua. Voit sytyttää lampun uudelleen, mutta tällöin energiasäästö on pienempi.

14. VALIKKORAKENNE

14.1 Valikko

1. vaihe	2. vaihe	3. vaihe	4. vaihe	5. vaihe
				
 – valitse, jotta voit siirtyä kohteeseen Valikko.	Valitse lisätoiminto Valikko-rakenteesta ja paina OK.	Valitse asetus.	OK - vahvista asetus painamalla.	Säädä arvoa ja paina OK.
Suoritettuasi puhdistuksen käännä uunitoimintojen nappivalitsin Off (virta sammutettu) -asentoon poistuaaksesi Valikko-valikosta.				

Valikko rakenne		
Avustava ruoanvalmistus 	Puhdistus 	Asetukset 

Asetukset					
01	Kellonaika	Muuta	02	Näytön kirkkaus	1 - 5

VALIKKORAKENNE

Asetukset					
03	Painikeäänet	1 – Ääni-merkki 2 – Painikeäänet 3 – Ääni pois päältä	04	Äänenvoimakkuus	1 - 4
05	Paistolämpömittari Toimenpide	1 – Hälytys ja pysäytys 2 – Hälytys	06	Ajastin	Päälle/Pois päältä
07	Uunivalo	Päälle/Pois päältä	08	Pikakuumennus	Päälle/Pois päältä
09	Muistutus puhdistamisesta	Päälle/Pois päältä	10	Wi-Fi-yhteys	Päälle/Pois päältä
11	Automaattinen kauko-ohjaus	Päälle/Pois päältä	12	Unohda verkko	Kyllä / Ei
13	Demo-toiminto	Aktivointi-koodi: 2468	14	Ohjelmistoversio	Tarkista
15	Palauta tehdasasetukset	Kyllä / Ei			

15. YMPÄRISTÖNSUOJELU

Kierrätä materiaalit, jotka on merkitty merkillä . Kierrätä pakkaus laittamalla se asianmukaiseen kierrätysastiaan. Suojele ympäristöä ja ihmisten terveyttä kierrättämällä sähkö- ja elektroniikkaromut. Älä hävitä merkillä  merkittyjä kodinkoneita kotitalousjätteen mukana. Palauta tuote paikalliseen kierrätyskeskukseen tai ota yhteyttä paikalliseen viranomaiseen.

VELKOMIN(N) TIL ELECTROLUX! ÞAKKA ÞÉR FYRIR AÐ VELJA HEIMILISTÆKIÐ OKKAR.



Til að auka sjálfbærni höfum við ákveðið að draga úr pappírnotkun og bjóðum nú notendahandbækur í heild sinni á netinu. Fáðu aðgang að notendahandbók þinni í heild sinni á electrolux.com/manuals



Fáðu leiðbeiningar um notkun, bæklinga, bilanaleit, þjónustu- og viðgerðarupplýsingar á electrolux.com/support



Til að fá fleiri uppskriftir, hugmyndir eða aðstoð skaltu sækja **My Electrolux Kitchen** appið.



EFNISYFIRLIT

1. ÖRYGGISUPPLÝSINGAR.....	121	6.3 Athugasemdir varðandi: Bökun með rökum blæstri.....	133
1.1 Öryggi barna og viðkvæmra einstaklinga.....	121	6.4	
1.2 Almenn t öryggi.....	121	Hvernig á að stilla: Eldunaraðstoð.....	133
2. ÖRYGGISLEIÐBEININGAR.....	123	6.5 Eldunaraðstoð.....	134
2.1 Uppsetning.....	123	7. TÍMASTILLINGAR.....	138
2.2 Rafmagnstenging.....	124	7.1 Klukkuaðgerðir.....	138
2.3 Notkun.....	124	7.2	
2.4 Umhirða og hreinsun.....	125	Hvernig á að stilla: Klukkuaðgerðir....	139
2.5 Hreinsun með eldglæðingu.....	125	8. AÐ NOTA FYLGIHLUTI.....	140
2.6 Innri lýsing.....	126	8.1 Aukabúnaður settur í.....	140
2.7 Þjónusta.....	126	8.2 Matvælskynjari.....	141
2.8 Förgun.....	126	9. VIÐBÓTARSTILLINGAR.....	142
3. VÖRULÝSING.....	127	9.1 Lás.....	142
3.1 Almenn t yfirlit.....	127	9.2 Slökkt sjálfvirkt.....	143
3.2 Aukabúnaður.....	127	9.3 Viftukæling.....	143
4. STJÓRNBOÐ.....	128	9.4 Vélræn hurðarlæsing.....	143
4.1 Inndraganlegir hnúðar.....	128	9.5 Hvernig á að nota: Vélræn hurðarlæsing.....	144
4.2 Yfirlit yfir stjórnboð.....	128	10. GÓÐ RÁÐ.....	145
4.3 Skjár.....	128	10.1 Ráðleggingar um eldun.....	145
5. FYRIR FYRSTU NOTKUN.....	129	10.2 Bökun með rökum blæstri.....	145
5.1 Upphafleg hreinsun.....	129	10.3 Bökun með rökum blæstri - ráðlagðir fylgihlutir.....	145
5.2 Upphafleg forhitun.....	130	10.4 Eldunartöflur fyrir prófunarstofur	146
5.3 Þráðlaus tenging 	130	11. UMHIRÐA OG HREINSUN.....	147
5.4 Hugbúnaðarleyfi.....	131	11.1 Athugasemdir varðandi þrif.....	148
6. DAGLEG NOTKUN.....	131	11.2 Hvernig á að þrifa: Drifverk ofnbotnsnis.....	148
6.1		11.3 Hvernig á að fjarlægja: Hilluberar.....	148
Hvernig á að stilla: Upphitunaraðgerðir.....	131		
6.2 Upphitunaraðgerðir.....	132		

11.4 Hvernig á að nota: Hreinsun með eldglæðingu.....	149	13. ORKUNÝTNI.....	154
11.5 Áminning um hreinsun.....	150	13.1 Vöruupplýsingar og vöruupplýsingaskjal.....	154
11.6 Hvernig á að fjarlægja og setja upp: Hurð.....	150	13.2 Orkusparnaður.....	155
11.7 Hvernig á að endurnýja: Ljós.....	151	14. SKIPULAG VALMYNDAR.....	156
12. BILANALET.....	152	14.1 Valmynd.....	156
12.1 Hvað skal gera ef.....	153	15. UMHVERFISMÁL.....	157
12.2 Þjónustugögn.....	154		

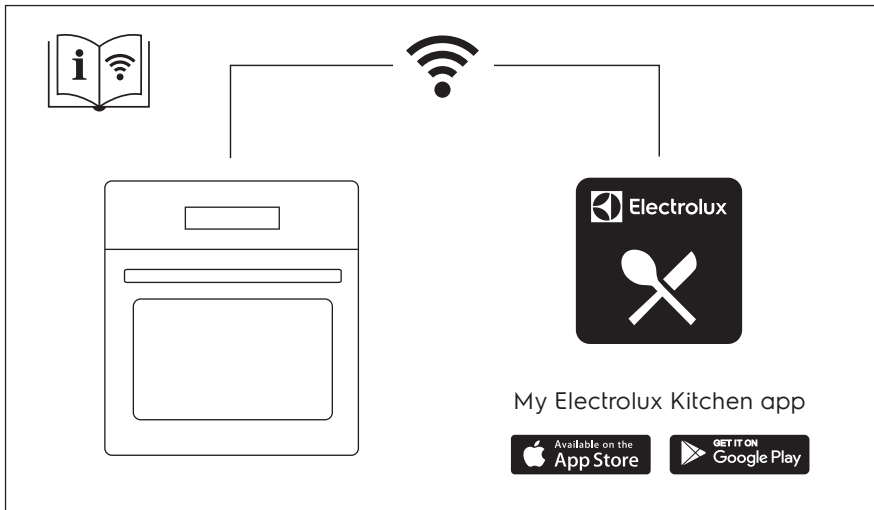

Með fyrirvara á breytingum.

1. ⚠ ÖRYGGISUPPLÝSINGAR

Fyrir uppsetningu og notkun heimilistækisins skal lesa meðfylgjandi leiðbeiningar vandlega. Framleiðandinn ber ekki ábyrgð á neinum meiðslum eða skemmdum sem leiða af rangri uppsetningu eða notkun. Geymdu alltaf leiðbeiningarnar á öruggum stað þar sem auðvelt er að nálgast þær til síðari notkunar.

1.1 Öryggi barna og viðkvæmra einstaklinga

- Börn, 8 ára og eldri og fólk með minnkaða líkamlega-, skyn- eða andlega getu, eða sem skortir reynslu og þekkingu, mega nota þetta tæki, ef þau eru undir eftirliti eða hafa verið veittar leiðbeiningar varðandi örugga notkun tækisins og ef þau skilja hættuna sem því fylgir. Halda skal börnum yngri en 8 ára gömlum og fólki með mjög miklar og flóknar fatlanir frá heimilistækinu, nema þau séu undir stöðugu eftirliti.
- Hafa ætti eftirlit með börnum til að tryggja að þau leiki sér ekki með heimilistækið og fartækið með My Electrolux Kitchen .
- Haltu öllum umbúðum frá börnum og fargaðu þeim á viðeigandi hátt.
- VIÐVÖRUN: Heimilistækið og aðgengilegir hlutar þess hitna meðan á notkun stendur. Haltu börnum og gæludýrum fjarri heimilistækinu þegar það er í notkun og þegar það kólnar.
- Ef heimilistækið er með barnalæsingu ætti hún að vera virkjuð.
- Börn eiga ekki að hreinsa eða framkvæma notandaviðhald á heimilistækinu án eftirlits.

1.2 Almenn öryggi

- Þetta heimilistæki er eingöngu ætlað til matreiðslu.
- Þetta heimilistæki er hannað til notkunar innanhúss á heimilum.

ÖRYGGISUPPLÝSINGAR

- Þetta heimilistæki má nota á skrifstofum, í herbergjum hótela, herbergjum gestahúsa, bændagistingum og öðrum sambærilegum gistirýmum þar sem notkun er ekki meiri en almenn heimilisnotkun.
- Einungis til þess hæfur aðili má setja upp þetta heimilistæki og skipta um snúruna.
- Ekki má nota heimilistækið fyrr en innbyggða virkið hefur verið uppsett.
- Aftengdu heimilistækið frá rafmagns- og vatnsinntaki áður en hvers kyns viðhaldsvinna fer fram.
- Ef rafmagnssnúra er skemmd verður framleiðandi, viðurkennd þjónustumiðstöð, eða svipað hæfur aðili að endurnýja hana til að forðast hættu vegna rafmagns.
- VIÐVÖRUN: Tryggðu að slökkt sé á heimilistækinu áður en þú skiptir um ljósið til að forðast möguleika á raflosti.
- VIÐVÖRUN: Heimilistækið og aðgengilegir hlutar þess hitna meðan á notkun stendur. Gæta ætti varúðar þegar hitunarelementin eru snert eða yfirborð holrýmis heimilistækisins.
- Notaðu alltaf hanska við að taka úr og setja í aukahluti eða eldföst matarílát.
- Notaðu aðeins þann matarmæli (kjöthitamæli) sem ráðlagður er fyrir þetta heimilistæki.
- Til þess að taka hillustuðninginn úr skal fyrst toga í framhluta hillustuðningsins og síðan afturhluta hans frá hliðarveggjunum. Komdu hilluberunum fyrir í öfugri röð.
- Notaðu ekki gufuhreinsibúnað til að hreinsa heimilistækið.
- Notaðu ekki sterk tærandi hreinsiefni eða beittar málmköfur til að hreinsa glerhurðina þar sem slíkt getur rispað yfirborðið, sem getur aftur leitt til þess að glerið brotnar.
- Fyrir hitahreinsun skaltu fjarlægja alla aukahluti og allt sem er inni í rými heimilistækisins.

2. ÖRYGGISLEIÐBEININGAR

2.1 Uppsetning

ADVÖRUN!

Einungis löggildur aðili má setja upp þetta heimilistæki.

- Fjarlægðu allar umbúðir.
- Ekki setja upp eða nota skemmt heimilistæki.
- Fylgdu leiðbeiningum um uppsetningu sem fylgja með heimilistækinu.
- Alltaf skal sýna aðgát þegar heimilistækið er færð vegna þess að það er þungt. Notaðu alltaf öryggishanska og lokaðan skóbúnað.
- Dragðu heimilistækið ekki á handfanginu.
- Settu heimilistækið upp á öruggum og hentugum stað sem uppfyllir uppsetningarkröfur.
- Haltu lágmarksfjarlægð frá öðrum heimilistækjum og einingum.
- Áður en þú setur upp ófönn skaltu athuga hvort hurðin opnast án heftingar.
- Heimilistækið er útbúið rafstýrðu kælikerfi. Það þarf rafstraum til að geta gengið.
- Innbyggða einingin verður að standast kröfur DIN 68930.

Lágmarkshæð skáps (Lágmarkshæð skáps undir vinnuborði)	578 (600) mm
Breidd skáps	560 mm
Dýpt skáps	550 (550) mm
Hæð heimilistækis að framan	594 mm
Hæð heimilistækis að aftan	576 mm
Breidd heimilistækis að framan	595 mm
Breidd heimilistækis að aftan	559 mm
Dýpt heimilistækisins	567 mm
Innbyggð dýpt heimilistækisins	546 mm
Dýpt með opna hurð	1027 mm
Lágmarksstærð loftops. Op er staðsett neðst á bakhlið	560x20 mm
Lengd rafmagnssnúru. Snúra er staðsett í hægra horni bakhliðar	1500 mm
Festiskrúfur	4x25 mm

2.2 Rafmagnstenging



ADVÖRUN!

Hætta á eldi og raflosti.

- Allar rafmagnstengingar skulu framkvæmdar af viðurkenndum rafvirkja.
- Heimilistækið verður að vera jarðtengt.
- Gakktu úr skugga um að færíbreyturnar á merkiplötunni séu samhæfar við rafmagnsflokkun aðalæðar aflgjafa.
- Notaðu alltaf rétt ísetta innstungu sem ekki veldur raflosti.
- Notaðu ekki fjöltengi eða framlengingarsnúrur.
- Gakktu úr skugga um að rafmagnsklóin og snúran verði ekki fyrir skemmdum. Ef skipta þarf um rafmagnssnúru verður viðurkennd þjónustumiðstöð okkar að sjá um það.
- Ekki láta rafmagnssnúrurnar snerta eða koma nálægt hurð heimilistækisins, eða skotið undir heimilistækinu, sérstaklega þegar það er í gangi eða hurðin er heit.
- Vörn lifandi og einangraðra hluta gegn raflosti verður að vera fest þannig að ekki sé hægt að fjarlægja hana án verkfæra.
- Aðeins skal tengja rafmagnsklóna við rafmagnsinnstunguna í lok uppsetningarinnar. Gakktu úr skugga um að rafmagnsklóin sé aðgengileg eftir uppsetningu.
- Ef rafmagnsinnstungan er laus, skal ekki tengja rafmagnsklóna.
- Ekki toga í snúruna til að taka tækið úr sambandi. Taktu alltaf um klóna.
- Notaðu aðeins réttan einangrunarbúnað: Línuvarnarstraumloka, öryggi (öryggi með skrufgangi fjarlægð úr höldunni), lekaliða og spólurofa.
- Rafmagnsuppsetningin verður að vera með einangrunarbúnað sem leyfir þér að aftengja tækið frá stofnæð á öllum pólum. Einangrunarbúnaðurinn verður að hafa að lágmarki 3 mm snertiopnunarvidd.
- Lokaðu alveg hurð heimilistækisins áður en þú tengir rafmagnsklóna við innstunguna.
- Þessu tæki fylgja rafmagnskló og -snúra.

2.3 Notkun



ADVÖRUN!

Hætta á meiðslum, bruna og raflosti eða sprengingu.

- Breytið ekki eiginleikum heimilistækisins.
- Gangið úr skugga um að loftræstiop séu ekki stifluð.
- Látið heimilistækið ekki vera án eftirlits á meðan það er í gangi.
- Slökkvið á heimilistækinu eftir hverja notkun.
- Farið varlega þegar hurð heimilistækisins er opnuð á meðan það er í gangi. Heitt loft getur losnað út.
- Notið ekki heimilistækið með blautar hendur eða þegar það er í snertingu við vatn.
- Beitið ekki þrýstingi á opna hurð.
- Notið ekki heimilistækið sem vinnuvæði eða geymslusvæði.
- Opnið hurð heimilistækisins varlega. Notkun efna sem innihalda áfengi getur valdið blöndu af áfengi og lofti.
- Láttu ekki neista eða opinn eld komast í snertingu við heimilistækið þegar þú opnar hurðina.
- Setjið ekki eldfim efni eða hluti bleytta með eldfimum efnum í, nálægt, eða á heimilistækið.
- Deildu ekki Wi-Fi aðgangsorðinu þínu.



ADVÖRUN!

Hætta á skemmdum á heimilistækinu.

- Til að koma í veg fyrir skemmdir eða aflitun á gljáhúðinni:
 - setjið ekki ofnáhöld eða aðra hluti beint á botn heimilistækisins.
 - setjið ekki álpappír beint á botn heimilistækisins.
 - setjið ekki vatn beint inn í heitt heimilistækið.
 - látið ekki raka rétti og rök matvæli vera inni í heimilistækinu eftir að matreiðslu er lokið.
 - farið varlega þegar aukahlutir eru fjarlægðir eða settir upp.
- Aflitun á glerungnum eða ryðfríu stáli hefur engin áhrif á getu eða frammistöðu heimilistækisins.
- Notið djúpa skúffu fyrir rakar kökur. Ávaxtasafi veldur blettum sem geta verið varanlegir.
- Alltaf skal elda með hurð heimilistækisins lokaða.
- Ef heimilistækið er uppsett bak við innréttingarplötu (t.d. hurð) þá þarf að ganga úr skugga um að hurðin sé aldrei lokuð þegar tækið er í notkun. Hiti og raki geta safnast upp bak við lokaða innréttingarplötu og leitt til skemmda á tækinu, ytra byrði tækisins eða gólfi. Því skal ekki loka innréttingarplötunni fyrr en tækið hefur náð að kólna að fullu eftir notkun.

2.4 Umhirða og hreinsun



ADVÖRUN!

Hætta á meiðslum, eldsvoða eða skemmdum á heimilistækinu.

- Áður en viðhald fer fram skal slökkva á heimilistækinu og aftengja rafmagnsklóna frá rafmagnsinnstungunni.
- Gakktu úr skugga um að heimilistækið sé kalt. Hætta er á því að glerplöturnar brotni.
- Skiptið umsvifalaust um glerplötur ef þær verða fyrir skemmdum. Hafðu samband við viðurkennda þjónustumiðstöð.
- Farðu varlega þegar þú tekur hurðina af heimilistækinu. Hurðin er þung!
- Hreinsaðu heimilistækið reglulega til að yfirborðsefnin á því endist betur.
- Hreinsaðu tækið með rökum og mjúkum klút. Notaðu aðeins hlutlaus þvottaefni. Notaðu ekki rispandi efni, stálull, leysiefni eða málmhluti.
- Ef þú notar ofnasprey skaltu fara eftir öryggisleiðbeiningum á umbúðum þess.

2.5 Hreinsun með eldglæðingu



ADVÖRUN!

Hætta á meiðslum / eldsvoða / uppgufun efna (gufaureykur) við eldglæðingarstillingu.

- Áður en hreinsun með eldglæðingu fer fram og forhitun fer í gang skaltu fjarlægja úr ofnrýminu:
 - Allar matarleifar, dreggjar, olíu eða feiti sem lekið hefur niður.
 - alla hluti sem hægt er að losa (þ.m.t. plötur, plötubera í hliðum o.s.frv. sem fylgja heimilistækinu), sérstaklega alla viðloðunarfría potta, pönnur, bakka, áhöld o.s.frv.
- Lestu leiðbeiningar fyrir eldglæðingu vandlega.
- Haldið börnum frá heimilistækinu þegar hreinsun með eldglæðingu stendur yfir. Heimilistækið verður mjög heitt og berst heitt loft úr loftopum að framan.
- Hreinsun með eldglæðingu er aðgerð með háum hita sem getur losað gufur út frá leifum eftir eldun og byggingarefni og er því mælt með fyrir notendur að:
 - tryggja góða loftræstingu meðan á hreinsun með eldglæðingu stendur og eftir hana.

ÖRYGGISLEIÐBEININGAR

- tryggja góða loftræstingu meðan á forhitun stendur og eftir hana.
- Skvettu ekki né heldur settu vatn á ofnhurðina á meðan hreinsun með eldglæðingu stendur eða eftir hana til að forðast skemmdir á glerplötunum.
- Gufur sem koma frá öllum ofnum með eldglæðingu / matarleifum samkvæmt lýsingu eru ekki skaðlegar fyrir manneskjur, þ.m.t. börn eða fólk með undirliggjandi sjúkdóma.
- Haldið gæludýrum frá heimilistækinu á meðan hreinsun með eldglæðingu og forhitun stendur yfir. Lítil gæludýr (sérstaklega fuglar og skriðdýr) geta verið mjög viðkvæm fyrir breytingum á hitastigi og uppgufun.
- Viðloðunarfrítt yfirborð á pottum, pönnum, bökkum, áhöldum o.s.frv. geta orðið fyrir skemmdum vegna mikils hita við eldglæðingu í öllum ofnum sem búnir eru eldglæðingu og geta líka gefið frá sér lítilla skaðlegar gufur.

2.6 Innri lýsing



ADVÖRUN!

Hætta á raflosti.

- Varðandi ljósinn í þessari vöru og ljós sem varahluti sem seld eru sérstaklega: Þessi ljós eru ætluð að standast öfgakenndar aðstæður í heimilistækjum eins og hitastig, titring, raka eða til að senda upplýsingar um rekstrarstöðu tækisins. Þau eru ekki ætluð til að nota í öðrum tækjum og henta ekki sem lýsing í herbergjum heimila.
- Þessi vara inniheldur ljósgjafa í orkunýtniflokki G.
- Notaðu aðeins ljós með sömu tæknilýsingu.

2.7 Þjónusta

- Hafðu samband við viðurkennda þjónustumiðstöð til að gera við heimilistækið.
- Notaðu eingöngu upprunalega varahluti.

2.8 Förgun



ADVÖRUN!

Hætta á meiðslum eða köfnun.

- Hafðu samband við staðbundin yfirvöld fyrir upplýsingar um hvernig skuli farga heimilistækinu.
- Aftengdu tækið frá rafmagni.
- Klippitu rafmagnssnúruna af upp við heimilistækið og fargaðu henni.
- Fjarlægðu hurðarlokuna til að koma í veg fyrir að börn eða gæludýr festist inni í heimilistækinu.

3. VÖRULÝSING

3.1 Almennt yfirlit

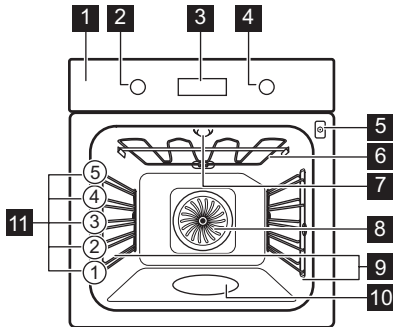

- 1** Stjórnborð
- 2** Hnúður fyrir hitunaraðgerðir
- 3** Skjár
- 4** Stjórnhnúður
- 5** Innstunga fyrir matvælaskynjara
- 6** Hitunareining
- 7** Ljós
- 8** Vífta
- 9** Hilluberarar, lausir
- 10** Holrými ofnhólfs
- 11** Hillustöður

3.2 Aukabúnaður

Vírhillla

Fyrir eldunaráhöld, kökuform, steikur.

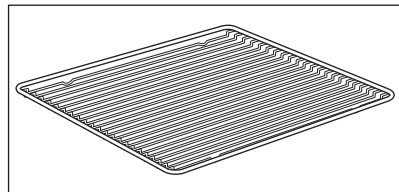

Bökunarplata

Fyrir kökur og smákökur.

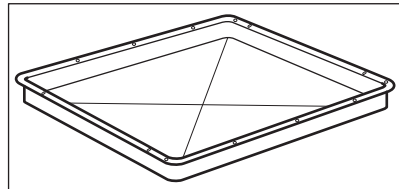

Grill- / steikingarskúffa

Til að baka og steikja eða sem ílát til að safna fitu.

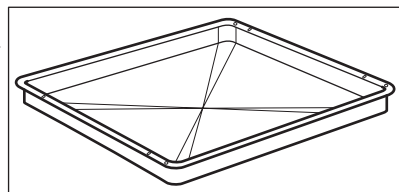

STJÓRNBORÐ

Sætabrauðsplata

Fyrir rúllutertur, saltkringlur og lítil sætabrauð. Hentugt fyrir gufuaðgerðir. Upplitun á yfirborðinu hefur engin áhrif á aðgerðirnar.

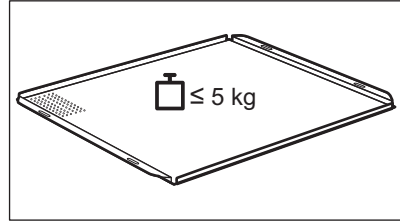

Matvælaskynjari

Að mæla hitastigið inni í matvælum.

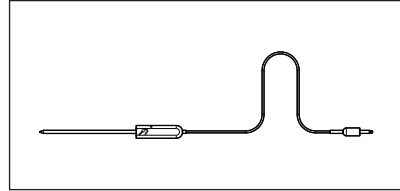







4. STJÓRNBORÐ

4.1 Inndraganlegir hnúðar

Til að nota heimilistækið skaltu ýta á hnúðinn. Hnúðurinn kemur út.

4.2 Yfirlit yfir stjórnborð





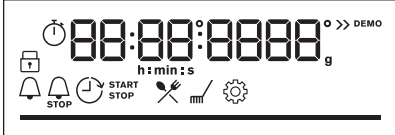







				OK		
Tímast- illir	Hröð upphitun	Létt	Matvæl- askynjari	Staðfesta stillingu	Ýttu á hnapp- inn	Snúðu hnúðn- um
Veldu hitunaraðgerð til að kveikja á heimilistækinu.						
Snúðu hnúðnum fyrir hitunaraðgerðir í stöðuna slökkt til að slökkva á heimilistækinu.						

4.3 Skjár

	Skjár með lykilaðgerðum.
---	--------------------------

FYRIR FYRSTU NOTKUN

Skjávísar

Grunnvísar				
 Lás	 Eldunaraðstoð	 Hreinsun	 Stillingar	 Hröð upphitun
Tímatökuvísar				
 Mínútumælir	 Lokatími	 Tímaseinkun	 Upptalning	
 Kveikt er á Wi-Fi tengingu.		 Kveikt er á Fjarstýring.		
Wi-Fi vísir - blikkar þegar hægt er að tengja heimilistækið við Wi-Fi.		Fjarstýring vísir - hægt er að fjarstýra heimilistækinu.		
Framvindustika - fyrir hitastig eða tíma. Stíkan er alveg rauð þegar heimilistækið nær innstilltu hitastigi.		<hr/>		
Vísir fyrir gufueldun				
Matvælaskynjari vísir				

5. FYRIR FYRSTU NOTKUN



AÐVÖRUN!

Sjá kafla um Öryggismál.

5.1 Upphafleg hreinsun



Fyrir fyrstu notkun skaltu tæma heimilistækið og stilla tímann:

			 00:00 Stilltu tímann. Ýttu á OK.
---	---	---	---

5.2 Upphafleg forhitun



Forhitaðu tóman ofninn fyrir fyrstu notkun.

1. skref	Fjarlægðu allan aukabúnað og lausa hillubera úr ofninum.
2. skref	Stilltu hámarkshitastig fyrir aðgerðina:  Láttu ofninn vera í gangi í 1 klst.
3. skref	Stilltu hámarkshitastig fyrir aðgerðina:  Láttu ofninn vera í gangi í 15 mín.
 Lykt og reykur gæti komið frá ofninum meðan á forhitun stendur. Passaðu að herbergið sé loft-ræst.	

5.3 Þráðlaus tenging

Til að tengja heimilistækið þarftu:

- Þráðlaust netkerfi með nettengingu.
- Fartæki sem er tengt við sama þráðlausa netkerfið.

1. skref	Til að hala niðut My Electrolux Kitchen appi: Skannaðu QR-kóðann á merkisplatinu með myndavélinni á fartækinu þínu svo þér verði beint að heimasíðu Electrolux. Merkisplatan er á fremri ramma rýmis heimilistækisins. Þú getur einnig halað niður appinu beint úr App store.
2. skref	Fylgdu leiðbeiningum um samræmingu í appinu.
3. skref	Snúðu hnúðnum fyrir hitunaraðgerðir til að velja:  .
4. skref	Snúðu stjórnunarhnúðnum til að velja: Stillingar. Kveiktu á Wi-Fi. Sjá kaflann „Valmyndaruppbygging“.

Tíðni	2.4 GHz WLAN
	2400 - 2483.5 MHz
Samskiptareglur	IEEE 802.11b DSSS, 802.11g/n OFDM
Hámarks kraftur	EIRP < 20 dBm (100 mW)
Þráðlaust net - eining	NIUS-50

5.4 Hugbúnaðarleyfi

Hugbúnaðurinn í þessari vöru inniheldur íhluti sem eru byggðir á frjálsum og opnum hugbúnaði. Electrolux viðurkennir það sem opinn hugbúnaður og samtök um vélmenni hafa lagt til þróunarverkefnisins.

Til að fá aðgang að frumkóða þessa ókeypis og opna hugbúnaðarluta, þar sem leyfisveiting gerir birtingu að skilyrði, og til að fá aðgang að heildarupplýsingum um höfundarétt og viðeigandi leyfisskilyrði skaltu heimsækja: <http://electrolux.opensoftwarerepository.com> (mappa NIUS).

6. DAGLEG NOTKUN



ADVÖRUN!





Sjá kafla um Öryggismál.

6.1 Hvernig á að stilla: Upphitunaraðgerðir

1. skref	Snúðu hnúðnum fyrir hitunaraðgerðir og veldu hitunaraðgerð.
2. skref	Snúðu stjórnhnúðnum til að stilla hitastigið.
	- ýttu á og haltu inni til að kveikja á aðgerðinni: Hröð upphitun. Það er í boði fyrir sumar ofnaðgerðir.

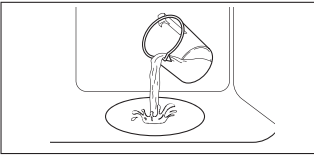





Gufueldun



Gakktu úr skugga um að ofninn sé kaldur.

1. skref	2. skref	3. skref	4. skref
			Forhitaðu ofninn í 10 mín til að mynda raka. Settu matvælin í ofninn.
Fylltu hólf ofnrýmisins með kranavatni.	Veldu gufuhitunaraðgerðina.	Stílltu hitastigið.	
<p> Hámarksrúmtak hólfs ofnrýmisins er 250 ml. Fylltu ekki aftur á hólf ofnrýmisins meðan á eldun stendur eða þegar ofninn er heitur.</p>			

Þegar gufueldun er lokið:		
1. skref	2. skref	3. skref
Snúðu hnúðnum fyrir hitunaraðgerðir í stöðuna slökkt til að slökva á ofninum.	Opnaðu hurðina varlega. Raki sem sleppur út getur valdið brunasárum.	Gakktu úr skugga um að ofninn sé kaldur. Fjarlægðu það vatn sem eftir er úr hólfri ofnrýmisins.

6.2 Upphitunaraðgerðir

Upphitunaraðgerð	Notkun
 <p>Eldun með hefðbundnum blæstri</p>	Til að baka á allt að þremur hillustöðum samtímis og að þurrka mat. Stilltu hitastigið 20 - 40°C lægra en í Hefðbundin matreiðsla.
 <p>Hefðbundin matreiðsla</p>	Til að baka og steikja í einni hillustöðu.
 <p>SteamBake</p>	Til að bæta við raka meðan á eldun stendur. Til að fá rétta litinn og stökka skorpu á meðan verið er að baka. Til að gera safaríkara meðan á endurhitun stendur. Til að geyma ávexti eða grænmeti.
 <p>Pítsuaðgerð</p>	Til að baka pítsu. Til að fá meiri brúnun og stökkan botn.
 <p>Undirhiti</p>	Til að baka kökur með stökkum botni og til að geyma mat.
 <p>Frosin matvæli</p>	Til að gera skyndirétti (t.d. franskar kartöflur, kartöflubáta eða vorúllur) stökka.
 <p>Bökun með rökum blæstri</p>	Þessi aðgerð er hönnuð til að spara orku á meðan eldað er. Þegar þú notar þessa aðgerð kann hitastigið í rýminu að vera frábrugðið innstilltu hitastigi. Afgangshiti er notaður. Hitunarkraftur kann að vera minni. Fyrir frekari upplýsingar má sjá kaflann „Dagleg notkun“, ráð fyrir: Bökun með rökum blæstri.

Upphitunaraðgerð	Notkun
 <p>Grill</p>	Til að grilla þunnar sneiðar af mat og til að rista brauð.
 <p>Blástursgrillun</p>	Til að steikja stór kjötstykki eða alifuglakjöt á beini á einni hillustöðu. Til að gera gratin-rétti og til að brúna.
 <p>Valmynd</p>	Til að fara í valmyndina: Eldunaraðstoð, Hreinsun, Stillingar.

i Eldun með hefðbundnum blæstri, Hefðbundin matreiðsla: Þegar þú stillir hitastigið undir 80°C slokknar sjálfkrafa á ljósinu eftir 30 sek.

6.3 Athugasemdir varðandi: Bökun með rökum blæstri

Þessi aðgerð var notuð til að uppfylla skilyrði flokkunar á orkunýtni og vishönnunar (í samræmi við EU 65/2014 og EU 66/2014). Prófanir í samræmi við: IEC/EN 60350-1

Ofnhurðin ætti að vera lokuð meðan á matreiðslu stendur þannig að aðgerðin verði ekki fyrir truflun og til þess að ofninn virki með bestu mögulegu orkunýtni.

Þegar þú notar þessa aðgerð slokknar ljósið sjálfkrafa eftir 30 sek.





Kynntu þér kaflann „Ábendingar og ráð“ varðandi eldunarleiðbeiningar, Bökun með rökum blæstri. Kynntu þér kaflann „Orkunýtni“, orkusparnaður varðandi almennar ráðleggingar hvað orkusparnaður varðar.

6.4 Hvernig á að stilla: Eldunaraðstoð





Sérhver réttur í þessari undirvalmynd hefur ráðlagða hitunaraðgerð og hitastig. Notaðu aðgerðina til að elda rétt í flýti með sjálfgefnum stillingum. Þú getur einnig aðlagð tímann og hitastigið á meðan eldun stendur.

Þú getur einnig eldað suma rétti með:	Það stig sem hver réttur er eldaður við:
<ul style="list-style-type: none"> Matvælaskynjari 	<ul style="list-style-type: none"> Lítið steikt Miðlungssteikt Gegnsteikt





1. skref	2. skref	3. skref	4. skref
----------	----------	----------	----------









			
Farðu í valmyndina.	Veldu Eldunaraðstoð. Ýttu á OK.	Veldu réttinn. Ýttu á OK.	Settu réttinn í ofninn. Staðfestu stillingu.

6.5 Eldunaraðstoð









Merking	
	Matvælaskynjari á boðstólnum. Settu Matvælaskynjari í þykkasta hluta réttarins. Heimilistækið slekkur á sér þegar innstilltu Matvælaskynjari hitastigi er náð.
	Vatnsmagn fyrir gufuaðgerðina.
	Forhitaðu heimilistækið áður en eldun hefst.
	Hillustaða.

Skjárinn sýnir **P** og **tölu** fyrir réttinn sem þú getur athugað í töflunni. Þegar aðgerðinni lýkur skaltu kanna hvort maturinn sé tilbúinn.

	Diskur	Þyngd	Hillustaða / Aukahlutur
1	Nautasteik, léttsteikt	1 - 1.5 kg; 4 - 5 cm þykkir bitar	  2; bökunarplata Steiktu kjötið í nokkrar mínútur á heitri pönnu. Settu inn í heimilistækið.
2	Nautasteik, miðlungs		
3	Nautasteik, gegnsteikt		
4	Steik, miðlungs	180 - 220 g hver sneið; 3 cm þykkar sneiðar	   3; steiktur réttur á vírhillu Steiktu kjötið í nokkrar mínútur á heitri pönnu. Settu inn í heimilistækið.













	Diskur	Þyngd	Hillustaða / Aukahlutur
5	Nautasteik / brösuð (framhryggur, hringsteik, þykk flankasteik)	1.5 - 2 kg	 2; steiktur réttur á vírhillu Steiktu kjötið í nokkrar mínútur á heitri pönnu. Bættu við vökva. Settu inn í heimilistækið.
6	Nautasteik, léttsteikt (hægeldun)	1 - 1.5 kg; 4 - 5 cm þykkir bitar	 2; bökunarplata Notaðu uppáhaldskryddin þín eða einfaldlega salt og nýmalaðan pipar. Steiktu kjötið í nokkrar mínútur á heitri pönnu. Settu inn í heimilistækið.
7	Nautasteik, miðlungs (hægeldun)		
8	Nautasteik, gegnsteikt (hægeldun)		
9	Lund, léttsteikt (hægeldun)	0,5 - 1,5 kg; 5 - 6 cm þykkir bitar	 2; bökunarplata Notaðu uppáhaldskryddin þín eða einfaldlega salt og nýmalaðan pipar. Steiktu kjötið í nokkrar mínútur á heitri pönnu. Settu inn í heimilistækið.
10	Lund, miðlungs (hægeldun)		
11	Lund, mikið elduð (hægeldun)		
12	Kálfasteik (t.d. öxl)	0.8 - 1.5 kg; 4 cm þykkir bitar	 2; steiktur réttur á vírhillu Notaðu uppáhaldskryddin þín. Bættu við vökva. Steik hulin.
13	Svínasteik hnakki eða bógur	1.5 - 2 kg	 2; steiktur réttur á vírhillu Snúðu kjötinu þegar eldunartíminn er hálfnaður.
14	Rifið svínakjöt (hægeldun)	1.5 - 2 kg	 2; bökunarplata Notaðu uppáhaldskryddin þín. Snúðu kjötinu þegar eldunartíminn er hálfnaður til að ná fram jafnri brúnun.
15	Hryggur, ferskur	1 - 1.5 kg; 5 - 6 cm þykkir bitar	 2; steiktur réttur á vírhillu Notaðu uppáhaldskryddin þín.
16	Svínaríf	2 - 3 kg; notaðu hrátt, 2 - 3 cm þunn rif	 3; djúp ofnskúffa Bættu við vökva til að hylja botninn á disknum. Snúðu kjötinu þegar eldunartíminn er hálfnaður.

DAGLEG NOTKUN

	Diskur	Þyngd	Hillustaða / Aukahlutur
17	Lambalæri með beini	1.5 - 2 kg; 7 - 9 cm þykkir bitar	 2; steiktur réttur á bökunarplötu Bættu við vökva. Snúðu kjötinu þegar eldunartíminn er hálfnaður.
18	Heill kjúklingur	1 - 1.5 kg; ferskt	 2;  200 ml; pottréttur á bökunarplötu Notaðu uppáhaldskryddin þín. Snúðu kjúklingnum þegar eldunartíminn er hálfnaður til að hann brúnist jafnt.
19	Hálfur kjúklingur	0.5 - 0.8 kg	 3; bökunarplata Notaðu uppáhaldskryddin þín.
20	Kjúklingabrjóst	180 - 200 g hver biti	  2; pottréttur á vírhilla Notaðu uppáhaldskryddin þín. Steiktu kjötið í nokkrar mínútur á heitri pönnu.
21	Kjúklingalæri, fersk	-	 3; bökunarplata Ef þú marinerar kjúklingaleggina fyrst skaltu stilla á lægra hitastig og elda þá lengur.
22	Önd, heil	2 - 3 kg	 2; steiktur réttur á vírhilla Notaðu uppáhaldskryddin þín. Settu kjötið á steikingardisk. Snúðu öndinni þegar eldunartíminn er hálfnaður.
23	Gæs, heil	4 - 5 kg	 2; djúp ofnskúffa Notaðu uppáhaldskryddin þín. Settu kjötið á djúpa bökunarplötu. Snúðu gæsinni þegar eldunartíminn er hálfnaður.
24	Kjöthleifur	1 kg	 2; vírhilla Notaðu uppáhaldskryddin þín.
25	Heill fiskur, grillaður	0.5 - 1 kgá hvern fisk	 2; bökunarplata Fylltu fiskinn með smjöri og uppáhalds kryddinu þínu og jurtum.
26	Fiskflök	-	 3; pottréttur á vírhilla Notaðu uppáhaldskryddin þín.





	Diskur	Þyngd	Hillustaða / Aukahlutur
27	Ostakaka	-	☐ 2; ∅ 28 cm kökuform á vírhillu
28	Eplakaka	-	☐ 2; 🍷 100 - 150 ml; bökunarplata
29	Eplabaka	-	☐ 2; bökuform á vírhillu
30	Eplabaka	-	☐ 2; 🍷 100 - 150 ml; ∅ 22 cm bökuform á vírhillu
31	Súkkulaðikökur	2 kg af deigi	☐ 3; djúp ofnskúffa
32	Súkkulaðibollakökur	-	☐ 2; 🍷 100 - 150 ml; formkökubakki á vírhillu
33	Formkaka	-	☐ 2; form á vírhillu
34	Bakaðar kartöflur	1 kg	☐ 2; bökunarplata Settu kartöflurnar heilar með hýðinu á bökunarplötu.
35	Bátar	1 kg	☐ 3; bökunarplata með bökunarpappír Notaðu uppáhaldskryddin þín. Skerðu kartöflurnar í bita.
36	Grillað blandað grænmeti	1 - 1.5 kg	☐ 3; bökunarplata með bökunarpappír Notaðu uppáhaldskryddin þín. Skerðu grænmetið í bita.
37	Krokkettur, frosnar	0.5 kg	☐ 3; bökunarplata
38	Franskar kartöflur, frosnar	0.75 kg	☐ 3; bökunarplata
39	Kjöt- / grænmetislasagne með þurrum núðluplötum	1 - 1.5 kg	☐ 2; pottréttur á vírhillu

TÍMASTILLINGAR

	Diskur	Þyngd	Hillustaða / Aukahlutur
40	Kartöflugratin (hráar kartöflur)	1 - 1.5 kg	 1; pottréttur á vírhillu Snúðu réttinum þegar eldunartíminn er hálfnaður.
41	Pítsa fersk, þunn	-	  2;  100 ml; bökunarplata með bökunarpappír
42	Pítsa fersk, þykk	-	  2; bökunarplata með bökunarpappír
43	Opnar eggjabökur	-	 2; kökuform á vírhillu
44	Snittubrauð / Ciabatta / Hvítt brauð	0.8 kg	  2;  150 ml; bökunarplata með bökunarpappír Hvítt brauð þarfnast meiri tíma.
45	Fjölkorna / rúgur / dökkt fjölkornabrauð í formi	1 kg	  2;  150 ml; bökunarplata með bökunarpappír / vírhillu

7. TÍMASTILLINGAR



7.1 Klukkuaðgerðir

Klukkuaðgerð	Notkun
 Mínútumælir	Þegar tíminn er liðinn hljómar merkið.
 Eldunartími	Þegar tíminn er liðinn hljómar merkið og hitunaraðgerðin stöðvast.
 Tímaseinkun	Til að fresta ræsingu og / eða lokum eldunar.
 Upptalning	Hámarkið er 23 klst. og 59 mín. Þessi aðgerð hefur engin áhrif á notkun ofnsins. Til að kveikja og slökva á Upptalning skaltu velja: Valmynd, Stillingar.

7.2 Hvernig á að stilla: Klukkuaðgerðir

Hvernig á að stilla: Tími dags		
1. skref	2. skref	3. skref
		
Til að breyta tíma dags skaltu fara í valmyndina og velja Stillingar, Tími dags.	Stilltu klukkuna.	Ýttu á: OK.

Hvernig á að stilla: Mínútumælir			
1. skref	Skjærinn sýnir: 0:00 	2. skref	3. skref
			
Ýttu á: 		Stilling á Mínútumælir	Ýttu á: OK.
 Tímastillirinn byrjar strax að telja niður.			

Hvernig á að stilla: Eldunartími				
1. skref	2. skref	Skjærinn sýnir: 0:00  STOP	3. skref	4. skref
				
Veldu hitunaraðgerð og stilltu hitastigið.	Ýttu endurtekið á: 		Stilltu eldunartímann.	Ýttu á: OK.
 Tímastillirinn byrjar strax að telja niður.				

AÐ NOTA FYLGIHLUTI

Hvernig á að stilla: Tímaseinkun							
1. skref	2. skref		3. skref	4. skref		5. skref	6. skref
		Skjárinn sýnir: tími dagsins			Skjárinn sýnir: --:--		
Veldu hitunar- aðgerð- ina.	Ýttu end- urtekið á: 	 BYRJA	Stilla upp- hafstí- mann.	Ýttu á: OK	 STÖÐ- VA	Stilla lok- atímann.	Ýttu á: OK
 Tíminnstillirinn byrjar að telja á stilltum upphafstíma.							

8. AÐ NOTA FYLGIHLUTI



ADVÖRUN!

Sjá kafla um Öryggismál.

8.1 Aukabúnaður settur í

Lítill skörð efst auka öryggi. Skörðin eru einnig búnaður sem kemur í veg fyrir að hlutir renni af. Háa brúnin umhverfis hilluna kemur í veg fyrir að eldunaráhöld renni niður af henni.

Vírhilla:

Ýttu hillunni milli stýristanganna á hilluber-
anum

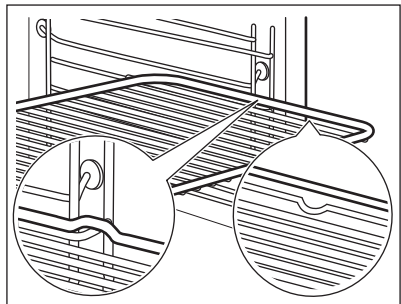

Bökunarplata / Djúp ofnskúffa:

Ýttu á bökunarplötunni á milli rásanna á hilluberanum.

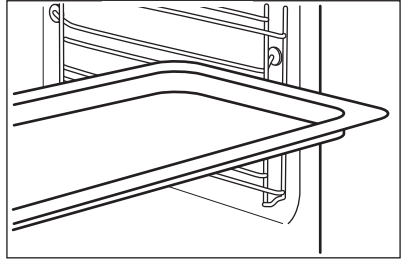

8.2 Matvælaskynjari

Matvælaskynjari - mælir hitastigið inni í matnum.

Hægt er að stilla á tvö hitastig:

°C
Hitinn á ofninum.

Kjarnahitinn.

Til að fá sem besta eldunarútkomu:

Hráefnin ættu að vera við stofuhita.



Ekki nota það fyrir rétti sem eru vökví.

Á meðan á eldun stendur verður það að vera í fatinu.

Hvernig á að nota: Matvælaskynjari



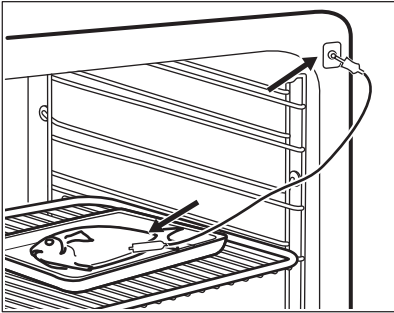
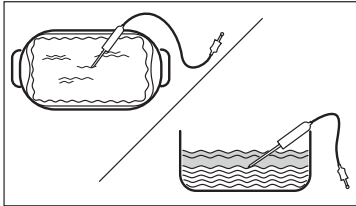



1. skref	Kveiktu á ofninum.
2. skref	Stilltu hitunaraðgerð og ef nauðsyn krefur, hitastig ofnsins.
3. skref	Settu inn: Matvælaskynjari.
Kjöt, alifuglar og fiskur	Pottréttur
Setjið oddinn á Matvælaskynjari inn í miðju kjötsins eða fisksins, í þykkasta hlutann ef hægt er. Gakktu úr skugga um að amk 3/4 af Matvælaskynjari sé inni í fatinu.	Settu oddinn á Matvælaskynjari nákvæmlega í miðjuna á pottréttfatinu. Matvælaskynjari ætti að vera stöðugt á einum stað við bakstur. Notaðu gegnheilt hráefni til að ná því. Notaðu brúnina á bökunarforminu til að styðja við silíkon handfangið á Matvælaskynjari. Endinn á Matvælaskynjari ætti ekki að snerta botninn á bökunarforminu.

VIÐBÓTARSTILLINGAR

	
4. skref	Stingdu Matvælaskynjari í innstunguna framan á ofninum. Skjárinn sýnir núverandi hitastig í: Matvælaskynjari.
5. skref	 - ýttu á til að stilla kjarnahitastigið fyrir mælinn.
6. skref	OK - ýttu á til að staðfesta. Þegar matvælin ná innstilltu hitastigi hjómar merkið. Þú getur valið að stöðva eða halda áfram eldun til að ganga úr skugga um að matvælin séu fullelduð.
7. skref	Taktu Matvælaskynjari tengið úr innstungunni og fjarlægðu fatið úr ofninum. <div data-bbox="213 842 1028 932" style="border: 1px solid black; padding: 5px;"> AÐVÖRUN! Hætta er á bruna þar sem Matvælaskynjari verður heitt. Vertu varkár þegar þú tekur hann úr sambandi og fjarlægir hann úr matnum.</div>



9. VIÐBÓTARSTILLINGAR

9.1 Lás

Þessi aðgerð kemur í veg fyrir að aðgerð heimilistækisins sé breytt fyrir slysi.		
Kveiktu á henni þegar heimilistækið er í gangi - stillt eldun heldur áfram, stjórnborðið er læst. Kveiktu á henni þegar slökkt er á heimilistækinu - ekki er hægt að kveikja á heimilistækinu, stjórnborðið er læst.		
 	 OK - ýttu á og haltu inni til að kveikja á aðgerðinni. Hjóðmerki heyrst.	 OK - ýttu á og haltu inni til að slökka á henni.
 3 x  - blikkar þegar kveikt er á lásnum.		

9.2 Slökkt sjálfvirkt

Af öryggisástæðum slekkur heimilistækið á sér eftir dálítinn tíma ef hitunaraðgerð er í gangi og þú breytir ekki neinum stillingum.

 (°C)	 (klst.)
30 - 115	12.5
120 - 195	8.5
200 - 245	5.5
250 - hámark	3

Slökkt sjálfvirkt virkar ekki með aðgerðunum: Létt, Matvælaskynjari, Tímaseinkun.

9.3 Viftukæling

Þegar heimilistækið gengur kviknar sjálfkrafa á kæliviftunni til að halda yfirborðsflötum heimilistækisins svölum. Ef þú slekkur á heimilistækinu gengur kæliviftan áfram þangað til heimilistækið kólnar.

9.4 Vélræn hurðarlæsing

Hurðin er ólæst þegar þú kaupir ofninn.

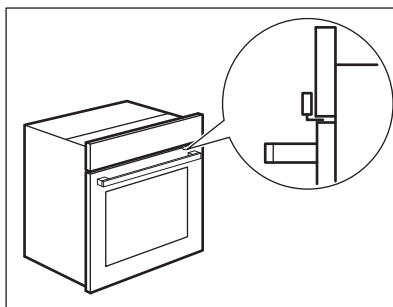

VIÐBÓTARSTILLINGAR

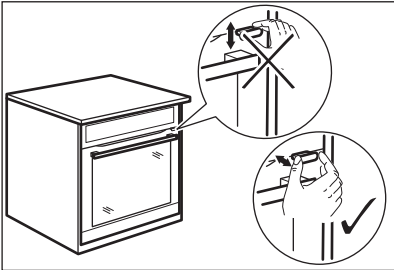
<p> VARÚÐ! Ekki fjarlægja hurðarlæsingu lóðrétt. Ekki ýta á hurðarlásinn þegar þú lokar ofnhurðinni.</p>	
--	---

9.5 Hvernig á að nota: Vélræn hurðarlæsing

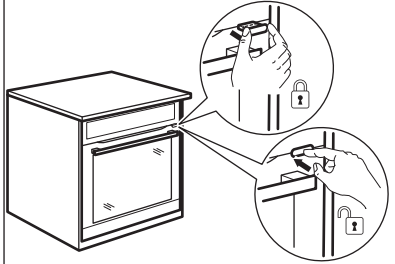
1. skref	Til að læsa hurðinni skaltu toga hurðarlæsingu fram á við þar til hún læsist.
2. skref	Til að aflæsa hurðinni skaltu ýta hurðarlásnum aftur inn í spjaldið. 

Læsta hurðin opnuð

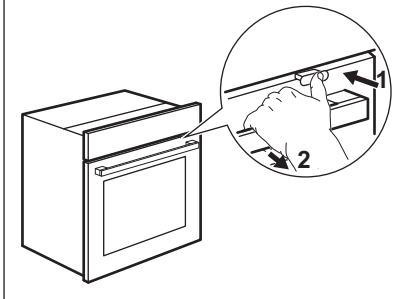
Þú getur opnað hurðina þegar hurðarlæsingin er á.	
1. skref	Ýttu aðeins á hurðarlæsingu og opnaðu hurðina með því að toga í handfangið. 
Þegar þú lokar hurðinni skaltu ganga úr skugga um að hurðarlæsingin haldist læst.	

10. GÓÐ RÁÐ

10.1 Ráðleggingar um eldun





Hitastigin og eldunartíminn á töflunum er aðeins til viðmiðunar. Það fer eftir uppskriftunum og gæðum og magni þess hráefnis sem notað er. Heimilistækið þitt kann að baka eða steikja á annan hátt en það heimilistæki sem þú hafðir áður. Ábendingarnar hér að neðan mæla með stillingum á hita, eldunartíma og hillustöðu fyrir tiltekna matartegundir. Ef þú finnur ekki stillingarnar fyrir ákveðna uppskrift skaltu leita að svipaðri uppskrift.

10.2 Bökun með rökum blæstri

Til að fá sem bestan árangur skaltu fylgja uppástungunum sem taldar eru upp í töflunni hér að neðan.

Notaðu þriðju hillustöðu.

	 (°C)	 (mín.)
Pastagrátín	200 - 220	45 - 55
Kartöflugrátín	180 - 200	70 - 85
Moussaka	170 - 190	70 - 95
Lasagna	180 - 200	75 - 90
Cannelloni	180 - 200	70 - 85
Brauðbúðingur	190 - 200	55 - 70
Hrísgrjónagrautur	170 - 190	45 - 60
Eplakaka, gerð úr svampkökublöndu (kringlótt kökuform)	160 - 170	70 - 80
Hvítt brauð	190 - 200	55 - 70

10.3 Bökun með rökum blæstri - ráðlagðir fylgihlutir





Notaðu dökk form og ílát sem endurkasta ekki ljósi. Þau gleypa betur hita en ljósir litir og diskar sem endurkasta ljósi.

 Pitsupanna	 Bökunarplata	 Bökunarform	 Kökuform
Dökkt, án endurskins 28 cm þvermál	Dökkt, án endurskins 26 cm þvermál	Keramík 8 cm þvermál, 5 cm hæð	Dökkt, án endurskins 28 cm þvermál

10.4 Eldunartöflur fyrir prófunarstofur





Upplýsingar fyrir prófunarstofnanir

Prófanir í samræmi við: EN 60350, IEC 60350.
Bakstur á einni hæð - bakstur í fornum





		 °C	 mín	
Fitulaus svampkaka	Eldun með hefðbundnum blæstri	160	45 - 60	2
Fitulaus svampkaka	Hefðbundin matreiðsla	160	45 - 60	2
Eplabaka, 2 dósir Ø20 cm	Eldun með hefðbundnum blæstri	160	55 - 65	2
Eplabaka, 2 dósir Ø20 cm	Hefðbundin matreiðsla	180	55 - 65	1
Smjörbrauð	Eldun með hefðbundnum blæstri	140	25 - 35	2
Smjörbrauð	Hefðbundin matreiðsla	140	25 - 35	2

Bakstur á einni hæð - kekkið
Notaðu þriðju hillustöðu.

UMHIRÐA OG HREINSUN

		 °C	 mín
Litlar kökur, 20 á plötu, forhitaðu tóman ofninn	Eldun með hefðbundnum blæstri	150	20 - 30
Litlar kökur, 20 á plötu, forhitaðu tóman ofninn	Hefðbundin matreiðsla	170	20 - 30





Bakstur á mörgum hæðum - kekjkökur

		 °C	 mín	
Smjörbrauð	Eldun með hefðbundnum blæstri	140	25 - 45	2 / 4
Litlar kökur, 20 á plötu, forhitaðu tóman ofninn	Eldun með hefðbundnum blæstri	150	25 - 35	1 / 4
Fitulaus svampkaka	Eldun með hefðbundnum blæstri	160	45 - 55	2 / 4
Eplabaka, 1 dós fyrir hverja grind (Ø 20 cm)	Eldun með hefðbundnum blæstri	160	55 - 65	2 / 4

Grill

Forhitaðu tóman ofninn í 5 mínútur.

Grillaðu með hámarkshitastillingunni.

		 mín	
Bauðrist	Grill	1 - 2	5
Nautasteik, snúa þegar tími er hálfnaður	Grill	24 - 30	4



11. UMHIRÐA OG HREINSUN



ADVÖRUN!

Sjá kafla um Öryggismál.

11.1 Athugasemdir varðandi þrif

 Hreinsiefni	Hreinsaðu heimilistækið að framan eingöngu með trefjaklút með volgu vatni og mildu hreinsiefni.
	Notaðu þrifalausn til að þrifa málmfleti.
	Þrifðu bletti með mildu hreinsiefni.
 Dagleg notkun	Hreinsaðu ofnhólfíð eftir hverja notkun. Fituuppsöfnun eða aðrar leifar geta valdið eldsvoða.
	Ekki geyma mat í heimilistækinu lengur en í 20 mínútur. Þurrkaðu hólfíð eingöngu með trefjaklút eftir hverja notkun.
 Aukabúnaður	Þrifðu alla aukahluti eftir hverja notkun og leyfðu þeim að þorna. Notið eingöngu trefjaklút með heitu vatni og mildu hreinsiefni. Ekki láta aukahlutina í uppþvottavél.
	Ekki þrifa viðloðunarfríu aukahlutina með slípandi hreinsiefni eða hlutum með beittum brúnum.

11.2 Hvernig á að þrifa: Drifverk ofnbotnsins

Gufuhreinsaðu hólf ofnrýmisins til að fjarlægja kalksteinsleifar eftir eldun.

1. skref	2. skref	3. skref
Helltu: 250 ml af hvítu ediki í hólf ofnrýmisins. Notaðu að hámarki 6% edik án neinna íblöndunarefna.	Láttu edikið leysa upp kalksteinsleifarnar við umhverfishita í 30 mínútur.	Hreinsaðu hólfíð með volgu vatni og mjúkum klút.
Fyrir aðgerðina SteamBake hreinsaðu ofninn á eftir 5 - 10 eldanir.		

11.3 Hvernig á að fjarlægja: Hilluberar

Til að hreinsa ofninn skaltu fjarlægja hilluberana.

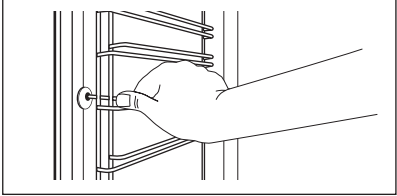
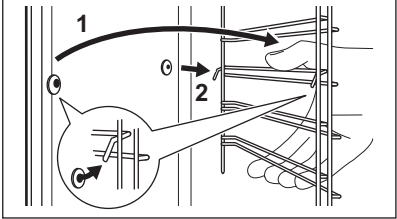
1. skref	Slökktu á ofninum og hinkraðu þar til hann hefur kólnað.	
2. skref	Togaðu framhluta hilluberans frá hliðarveggnum.	
3. skref	Togaðu afturenda hilluberans frá hliðarveggnum og fjarlægðu hann.	
4. skref	Komdu hilluberunum fyrir í öfugri röð.	

11.4 Hvernig á að nota: Hreinsun með eldglæðingu

Hreinsið ofninn með Hreinsun með eldglæðingu.



ADVÖRUN!

Hætta er á bruna.



VARÚÐ!

Ef önnur heimilistæki eru uppsett í sama skáp skal ekki nota þau á meðan þessi aðgerð er framkvæmd. Það getur valdið skemmdum á ofninum.



Fyrir Hreinsun með eldglæðingu:

Slökktu á ofninum og hinkraðu þar til hann hefur kólnað.	Fjarlægðu allan aukabúnað og lausa hillubera.	Hreinsaðu ofnbotninn og innri hurðargler með volgu vatni, mjúku klút og mildu þvottaefni.
--	---	---

Hreinsun með eldglæðingu

1. skref	Farið í valmynd: Hreinsun  .	
Valkostur	Tímalengd	
C1 - Létt hreinsun	1 h	
C2 - Venjuleg hreinsun	1 h 30 min	

UMHIRÐA OG HREINSUN

Hreinsun með eldglæðingu	
C3 - Ítarleg hreinsun	3 h
2. skref	OK - ýtið til að velja hreinsunarkerfi.
3. skref	OK - ýttu á til að hefja hreinsun.
4. skref	Eftir hreinsun skaltu snúa hnúðnum fyrir hitunaraðgerðir í slökkva-stöðuna.
 Þegar hreinsun hefst læsist hurðin á ofninum og ljósið er slökkt. Þar til hurðin fer úr lás og skjárást sýnir:  .	



Þegar hreinsun lýkur:		
Slökktu á ofninum og hink-raðu þar til hann hefur kólnað.	Hreinsaðu rýmið með mjúkum klút.	Fjarlægðu leifar í botni rýmisins.

11.5 Áminning um hreinsun

Ofninn minnir þig á að hreinsa með eldglærinu.	
 blikkar á skjánum í 5 sek eftir hverja eldun-arlotu.	Til að slökka á áminningunni skal fara í Valmynd og velja Stillingar, Áminning um hreinsun.

11.6 Hvernig á að fjarlægja og setja upp: Hurð

Þú getur fjarlægt hurðina og innri glerplöturnar til að hreinsa þær. Fjöldi glerplata er mismunandi eftir gerðum.

	AÐVÖRUN! Hurðin er þung.
	VARÚÐ! Meðhöndlaðu glerið varlega, einkum í kringum brúnir fremri plötunnar. Glerið getur brotnað.

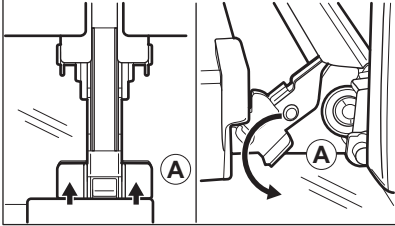
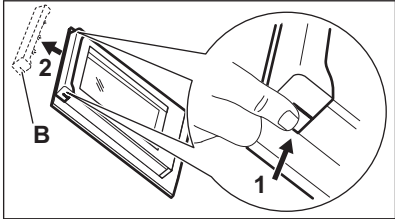
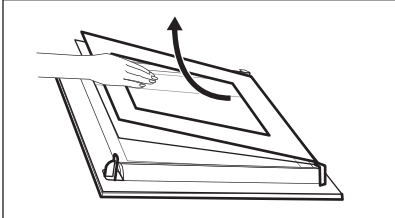
1. skref	Opnaðu hurðina að fullu.	
2. skref	Lyftu og þrýstu á klemmustangirnar (A) á hurðarlömunum tveimur.	
3. skref	Lokaðu ofnhurðinni í fyrstu opnunarstöðu (um það bil 70° halli). Haltu hurðinni á báðum hliðum og togaðu hana frá ofninum skáhallt upp. Settu hurðina með ytri hliðina niður á mjúkan klút á stöðugan flöt.	
4. skref	Haltu í hurðarklæðninguna (B) við efstu brún hurðarinnar á báðum hliðum og þrýstu inn á við til að losa klemmupétti.	
5. skref	Togaðu hurðarklæðninguna fram á við til að fjarlægja hana.	
6. skref	Haltu hurðarglerplötunum á efstu brún á hverri fyrir sig og togaðu þær upp úr rásinni.	
7. skref	Hreinsaðu glerplötuna með vatni og sápu. Þurrkaðu glerplötuna varlega. Ekki skal hreinsa glerplöturnar í uppþvottavél.	
8. skref	Eftir hreinsun skal framkvæma ofangreind skref í öfugri röð.	
9. skref	Settu litlu glerplötuna í fyrst, og síðan þá stærri og hurðina. Gakktu úr skugga um að glerin séu ísett í réttri stöðu, annars kann yfirborð hurðarinnar að ofhitna.	

11.7 Hvernig á að endurnýja: Ljós



ADVÖRUN!

Hætta á raflosti.

Ljósíð getur verið heitt.

BILANALET

Áður en skipt er um ljósaperu:

1. skref	2. skref	3. skref
Slökktu á ofninum. Hinkraðu þar til ofninn er orðinn kaldur.	Taktu ofninn úr sambandi við rafmagn.	Settu klút á botn rýmisins.

Toppljós

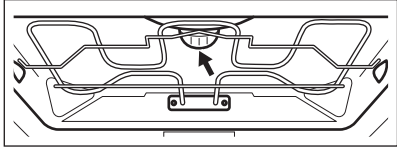
1. skref	Snúðu glerhlífinni til að fjarlægja hana.	
2. skref	Hreinsaðu glerhlífina.	
3. skref	Skiptu um peru með viðeigandi 300 °C hitapolinni ljósaperu.	
4. skref	Komdu glerhlífinni fyrir.	

Hliðarljósapera

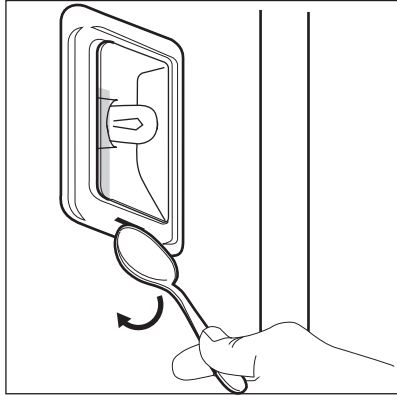
1. skref	Fjarlægðu vinstri hillubera til að fá aðgang að ljósaperunni.	
2. skref	Notaðu mjóan, bitlausan hlut (t.d. teskeið) til að fjarlægja glerhlífina.	
3. skref	Hreinsaðu glerhlífina.	
4. skref	Skiptu um peru með viðeigandi 300 °C hitapolinni ljósaperu.	
5. skref	Komdu glerhlífinni fyrir.	
6. skref	Komdu vinstri hillubera fyrir.	

12. BILANALET



ADVÖRUN!

Sjá kafla um Öryggismál.

12.1 Hvað skal gera ef...

Hafðu samband við viðurkennda þjónustumiðstöð ef um atvik er að ræða sem ekki er að finna í þessari töflu.



Ekki kviknar á heimilistækinu eða það hitnar ekki

Vandamál	Athugaðu eftirfarandi...
Ekki er hægt að ræsa eða nota heimilistækið.	Heimilistækið er rétt tengt við rafmagn.
Heimilistækið hitnar ekki.	Slökkt hefur verið á Slökkt sjálfvirkt-aðgerðinni.
Heimilistækið hitnar ekki.	Hurðin á heimilistækinu er lokuð.
Heimilistækið hitnar ekki.	Rafmagnsörygginu hefur ekki slegið út.
Heimilistækið hitnar ekki.	Slökkt er á lásnum.



Íhlutir

Vandamál	Athugaðu eftirfarandi...
Slökkt er á ljósinu.	Bökun með rökum blæstri - kveikt.
Ljósíð virkar ekki.	Ljósaperan er ónýtt.
Matvælaskynjari virkar ekki.	Klío Matvælaskynjari er að fullu sett inn í innstunguna.



Villukóðar

Skjárinn sýnir...	Athugaðu eftirfarandi...
Villukóði C2	Þú tókst Matvælaskynjari klóna úr sambandi.
Villukóði C3	Hurðin á heimilistækinu er lokuð eða hurðarlæsing er ekki biluð.
Villukóði F102	Hurðin á heimilistækinu er lokuð.

ORKUNÝTNI

 Villukóðar	
Villukóði F102	Hurðarlæsingin er ekki biluð.
00:00	Rafmagnið fór af. Stílltu tíma dags.
Ef skjárin sýnir villukóða sem er ekki í þessari töflu skaltu slökkva og kveikja aftur á öryggistöflunni á heimilinu og endurræsa síðan heimilistækið. Ef villukóðinn kemur aftur upp skaltu hafa samband við viðurkennda þjónustumiðstöð.	

 Hreinsun	
Vandamál	Athugaðu eftirfarandi...
Vatnið lekur út úr holrými ofnhólsins.	Það er of mikið vatn í holrými ofnhólsins.

12.2 Þjónustugögn

Ef þú getur ekki sjálf(ur) fundið lausn á vandamálinu skaltu hafa samband við söluaðila eða viðurkennda þjónustumiðstöð.

Þær nauðsynlegu upplýsingar sem þjónustumiðstöðin þarf á að halda eru á merkiplötunni. Merkiplatan er á fremri ramma rýmis heimilistækisins. Fjarlægðu ekki merkiplötuna af rými heimilistækisins.

Við mælum með því að þú skrifir upplýsingarnar hér:	
Gerð (MOD.)
Vörunúmer (PNC)
Raðnúmer (S.N.)

13. ORKUNÝTNI

13.1 Vöruupplýsingar og vöruupplýsingaskjal

Heiti birgja	Electrolux
--------------	------------

Auðkenni tegundar	COP827V 944032113 COP827X 944032112 EO82PBK 944032114	
Orkunýtnistuðull	81.2	
Orkunýtniflokkur	A+	
Orkunotkun með staðlaðri hleðslu, hefðbundinn hamur	1.09 kWh/lotu	
Orkunotkun með staðlaðri hleðslu, viftudrifinn hamur	0.69 kWh/lotu	
Fjöldi holrýma	1	
Hitagjafi	Rafmagn	
Hljóðstyrkur	71 l	
Tegund ofns	Innbyggður ofn	
Massi	COP827V	35.0 kg
	COP827X	35.0 kg
	EO82PBK	35.0 kg

IEC/EN 60350-1 - Rafmagnseldunartæki til heimilisnota - 1. hluti: Svið, ofnar, gufuofnar og grill - Tegundir afkastamælinga.

13.2 Orkusparnaður



Heimilistækið hefur eiginleika sem hjálpa þér að spara orku við hversdagslega matreiðslu.

Gættu þess að hurðin á heimilistækinu sé almennilega lokað þegar tækið er í gangi. Ekki opna hurðina á heimilistækinu of oft á meðan eldað er. Haltu kanti hurðarinnar hreinum og gættu þess að hann sé vel festur á sínum stað.

Notaðu eldhúsáhöld úr málm til að bæta orkusparnað.

Þegar mögulegt er skal ekki forhita heimilistækið fyrir eldun.

Hafðu eins stutt hlé í bakstrinum og mögulegt er þegar þú undirbýrð nokkra rétti í einu.

Eldun með viftu

Þegar mögulegt er skaltu nota eldunaraðgerðir með viftu til að spara orku.

Afgangshiti

Áfram er kveikt á ljósinu og viftunni. Þegar þú slekkur á heimilistækinu sýnir skjárin afgangshitann. Þú getur notað þann hita til að halda matnum volgum.

Þegar eldun tekur lengri tíma en 30 mínútur skaltu lækka hita heimilistækisins eins mikið og hægt er 3 - 10 mínútum áður en eldun er lokið. Afgangshiti inn í heimilistækinu mun halda áfram að elda matinn.

SKIPULAG VALMYNDAR

Notaðu afgangshitann til að hita upp aðra rétti.

Halda mat heitum

Veldu lægstu mögulegu hitastillingu til að nota afgangshita og halda máltíð heitri. Vísirinn fyrir afgangshita eða hitastig birtist á skjánum.

Eldun með ljósið slökkt

Slökktu á ljósinu meðan á eldun stendur. Kveiktu aðeins á því þegar þú þarft þess.

Bökun með rökum blæstri

Aðgerð hönnuð til að spara orku á meðan eldað er.



Þegar þú notar þessa aðgerð slokknar ljósið sjálfkrafa eftir 30 sekúndur. Þú getur kveikt aftur á ljósinu en sú aðgerð minnkar væntanlegan orkusparnað.

14. SKIPULAG VALMYNDAR

14.1 Valmynd

1. skref	2. skref	3. skref	4. skref	5. skref
				
 - veldu til að fara í Valmynd.	Veldu valkostinn í Valmynd samsetningunni og ýttu á OK.	Veldu hitastillinguna.	OK - ýttu á til að staðfesta stillingu.	Breyttu gildinu og ýttu á OK.



Snúðu hnúðnum fyrir hitunaraðgerðir í slökkva-stöðuna til að fara út úr Valmynd.

Valmynd uppbygging		
Eldunaraðstoð 	Hreinsun 	Stillingar 

Stillingar					
01	Tími dags	Breyta	02	Skjábirta	1 - 5
03	Lykiltónar	1 - Píp 2 - Smellur 3 - Hljóð af	04	Hljóðstyrkur hljóðgjafa	1 - 4
05	Matvælaskynjari Aðgerð	1 - Viðvörðun og stöðva 2 - Viðvörðun	06	Upptalning	Kveikja / Slökkva

Stillingar					
07	Létt	Kveikja / Slökkva	08	Hröð upphitun	Kveikja / Slökkva
09	Áminning um hreinsun	Kveikja / Slökkva	10	Wi-Fi	Kveikja / Slökkva
11	Sjálfvirk fjarstýring	Kveikja / Slökkva	12	Gleyma netkerfi	Já / Nei
13	Kynningarhamur	Virkjunarkóði: 2468	14	Útgáfa hugbúnaðar	Athuga
15	Endursetja allar stillingar	Já / Nei			

15. UMHVERFISMÁL

Endurvinnna þarf öll efni merkt táknum . Setjið umbúðirnar í viðeigandi sorpílát til endurvinnslu. Leggið ykkar að mörkum til verndar umhverfinu og heilsu manna og dýra og endurvinnið rusl sem fylgir raftækjum og rafrænum búnaði. Hendið ekki heimilistækjum sem merkt eru með táknum  í venjulegt heimilisrusl. Farið með vöruna í næstu endurvinnslustöð eða hafið samband við sveitarfélagið.

VELKOMMEN TIL ELECTROLUX! TAKK FOR AT DU VALGTE APPARATET VÅRT.



Som en del av vårt bærekraftighetsprosjekt, reduserer vi papirsavfall og tilbyr fullstendig brukerhåndbøker på nettet. Få tilgang til de fullstendige håndbøkene på electrolux.com/manuals



Få råd om bruk, brosjyrer, løse problemer, service- og reparasjonsinformasjon electrolux.com/support



For flere oppskrifter, tips, feilsøking last ned **My Electrolux Kitchen** appen.



INNHOOLD

1. SIKKERHETSINFORMASJON.....	160	6.4 Slik stiller du inn:	
1.1 Sikkerhet for barn og sårbare mennesker.....	160	Assistert matlaging.....	172
1.2 Generell sikkerhet.....	160	6.5 Assistert matlaging.....	172
2. SIKKERHETSANVISNINGER.....	161	7. KLOKKEFUNKSJONER.....	176
2.1 Montering.....	161	7.1 Klokkefunksjonene.....	176
2.2 Elektrisk tilkobling.....	162	7.2	
2.3 Bruk.....	163	Slik stiller du inn: Klokkefunksjonene.....	177
2.4 Stell og rengjøring.....	164	8. BRUKE TILBEHØRET.....	178
2.5 Pyrolytisk rengjøring.....	164	8.1 Innsetting av tilbehør.....	178
2.6 Innvendig lys.....	165	8.2 Steketermometer.....	179
2.7 Tjenester.....	165	9. TILLEGGSFUNKSJONER.....	180
2.8 Avfallshåndtering.....	165	9.1 Sperre.....	180
3. PRODUKTBEKRIVELSE.....	165	9.2 Automatisk utkopling.....	181
3.1 Generell oversikt.....	165	9.3 Kjølevifte.....	181
3.2 Tilbehør.....	166	9.4 Mekanisk dørlås.....	181
4. BETJENINGSPANEL.....	166	9.5 Slik bruker du: Mekanisk dørlås... ..	182
4.1 Skjult lås.....	166	10. RÅD OG TIPS.....	183
4.2 Oversikt over betjeningspanel.....	167	10.1 Råd om tilberedning.....	183
4.3 Display.....	167	10.2 Baking med fukt.....	183
5. FØR FØRSTE GANGS BRUK.....	168	10.3 Baking med fukt – anbefalt tilbehør.....	183
5.1 Første gangs rengjøring.....	168	10.4 Tilberedningstabeller for testinstitutter.....	184
5.2 Første gangs forvarming.....	168	11. STELL OG RENGJØRING.....	185
5.3 Trådløs tilkobling 	168	11.1 Merknader om rengjøring.....	186
5.4 Programvarelisenser.....	169	11.2 Slik rengjør du: Gravert ovnsrom.....	186
6. DAGLIG BRUK.....	169	11.3 Slik fjerner du: Gyllestøtter	186
6.1		11.4 Bruk: Pyrolytisk rengjøring.....	187
Slik stiller du inn: Varmefunksjoner....	169	11.5 Rengjøringspåminnelse.....	188
6.2 Varmefunksjoner.....	170	11.6 Slik fjerner og monterer du: Dør	188
6.3 Merknader om: Baking med fukt..	171	11.7 Slik bytter du: Ovnslampe.....	189

12. FEILSØKING.....	190	13.2 Energisparing.....	193
12.1 Hva må gjøres, hvis.....	191	14. MENYSTRUKTUR.....	194
12.2 Servicedata.....	192	14.1 Meny.....	194
13. ENERGIEFFEKTIV.....	192	15. BESKYTTELSE AV MILJØET.....	195
13.1 Produktinformasjon og produktinformasjonsark.....	192		

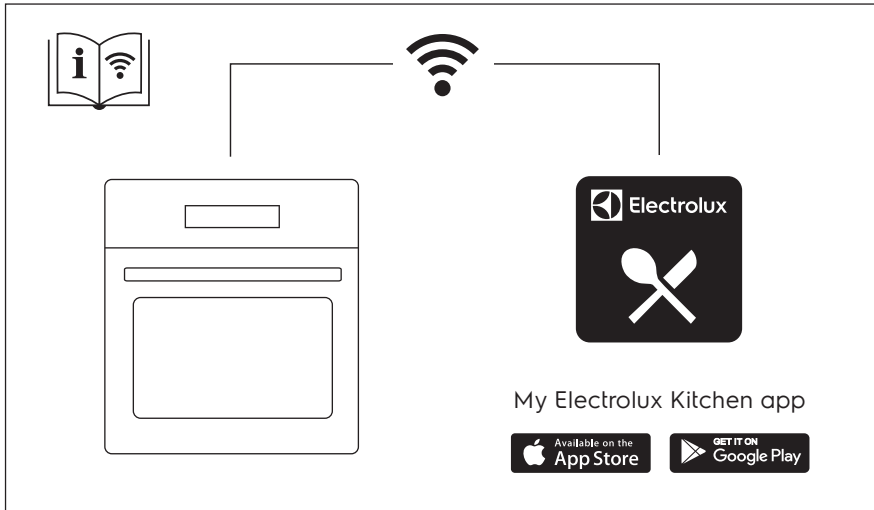

Med forbehold om endringer.

1. ⚠️ SIKKERHETSINFORMASJON

Les medfølgende instruksjoner nøye innen du installerer og bruker apparatet. Produsenten er ikke ansvarlig for personskader eller andre skader som følge av feilaktig montering eller bruk. Hold alltid instruksjonene på et trygt og tilgjengelig sted for fremtidig referanse.

1.1 Sikkerhet for barn og sårbare mennesker

- Dette produktet kan brukes av barn fra 8 år og oppover og personer med reduserte fysiske, sensoriske eller mentale evner eller manglende erfaring og kunnskap, dersom de får tilsyn eller instruksjoner om bruken av produktet på en sikker måte, og forstår farene som er involvert. Barn under 8 år og personer med svært omfattende og komplekse funksjonsnedsettelse må holdes på avstand fra produktet med mindre de er under tilsyn til enhver tid.
- Barn bør være under oppsyn for å sikre at de ikke leker med produktet og mobile enheter med My Electrolux Kitchen .
- Oppbevar all emballasje utilgjengelig for barn og kast den på riktig måte.
- ADVARSEL: Produktet og tilgjengelige deler blir varme under bruk. Hold barn og kjæledyr borte fra apparatet når det er i bruk og når det kjøles ned.
- Hvis produktet har en barnesikring, bør den aktiveres.
- Rengjøring og vedlikehold av produktet skal ikke utføres av barn.

1.2 Generell sikkerhet

- Dette produktet skal kun brukes til matlaging.
- Dette produktet er beregnet for bruk innendørs.
- Dette produktet kan brukes på kontorer, hotellrom, rom for bed & breakfast, gårdsgjestehus og andre lignende steder hvor slik bruk ikke overstiger (gjennomsnittlig) bruksnivåer for husholdningsrom.

- Bare en kvalifisert person må montere produktet og skifte ut kabelen.
- Bruk ikke produktet før du installerer det i en innebygget enhet.
- Trekk støpselet ut av stikkontakten før du utfører vedlikehold.
- Om stikkontakten er skadet må den erstattes av produsenten, et autorisert servicesenter eller tilsvarende kvalifiserte personer for å unngå at den kan utgjøre en elektrisk fare.
- **ADVARSEL:** Sørg for at produktet er slått av før du bytter lampen for å unngå fare for elektrisk støt.
- **ADVARSEL:** Produktet og tilgjengelige deler blir varme under bruk. Vær forsiktig så du ikke berører varmeelementene eller produktrommets overflate.
- Bruk alltid grillvotter til å fjerne eller sette inn tilbehør eller ovnsutstyr.
- Bruk kun matsensoren (steketermometeret) som anbefales for dette produktet.
- For å fjerne ovnsstigene, må du først trekke dem ut i front og siden i bakkant. Monter ovnsstigene i motsatt rekkefølge.
- Ikke bruk damprengjøring til å rengjøre produktet.
- Ikke bruk skurende rengjøringsmidler eller skarpe skrapegjenstander av metall for å rengjøre glassdøren, da dette kan ripe opp glasset og føre til at glasset blir matt.
- Før pyrolytisk rengjøring må alt tilbehør og overflødige avleiringer/søl fjernes fra ovnen.

2. SIKKERHETSANVISNINGER

2.1 Montering

**ADVARSEL!**

Bare en kvalifisert person må montere dette produktet.

- Fjern all emballasje.
- Ikke monter eller bruk et skadet produkt.
- Følg installasjonsanvisningene som følger med produktet.

SIKKERHETSANVISNINGER

- Vær alltid forsiktig når du flytter produktet. Det er tungt. Bruk alltid vernebriller og lukket føttøy.
- Ikke dra eller løft produktet etter håndtaket.
- Monter produktet på et trygt og egnet sted som oppfyller monteringskrav.
- Overhold minimumsavstanden fra andre produkter og enheter.
- Før du monterer produktet, sjekk at produktdøren åpner uten hindring.
- Produktet er utstyrt med et elektrisk kjølesystem. Det må brukes med elektrisk strømforsyning.
- Innbyggingseenheten må møte kravene til stabilitet i DIN 68930.

Minstehøyde for skap (minstehøyde for skap under benkeplate)	578 (600) mm
Skapbredde	560 mm
Skapdybde	550 (550) mm
Høyden av fronten av produktet	594 mm
Høyden av baksiden av produktet	576 mm
Bredden av fronten av produktet	595 mm
Bredden av baksiden av produktet	559 mm
Dybden av produktet	567 mm
Produktets innebygde dybde	546 mm
Dybde med døren åpen	1027 mm
Minsteåpning for ventilasjon. Åpning er plassert på nedre bakside	560x20 mm
Lengden på strømledningen. Strømledningen finner du i høyre hjørne på baksiden	1500 mm
Monteringsskruer	4x25 mm

2.2 Elektrisk tilkobling



ADVARSEL!

Fare for brann og elektrisk støt.

- Alle elektriske tilkoblinger skal utføres av en kvalifisert elektriker.
- Produktet må være jordet.
- Kontroller at parametrene på typeskiltet er kompatible med de elektriske spesifikasjonene i strømforsyningen.

- Bruk alltid en korrekt montert, jordnet stikkontakt.
- Ikke bruk grenuttak eller skjøteledninger.
- Pass på at støpselet og strømkabelen ikke påføres skade. Hvis strømkabelen må erstattes, må dette utføres av vårt Autoriserte servicesenter.
- Strømkablene må ikke berøre eller komme nær apparatets dør eller sprekken under apparatet, spesielt ikke når den er i bruk eller når døren er varm.
- Beskyttelsen mot elektrisk støt fra strømførende og isolerte deler må festes på en måte som gjør at den ikke kan fjernes uten verktøy.
- Ikke sett støpselet i stikkontakten før monteringen er fullført. Påse at det er tilgang til stikkontakten etter monteringen.
- Hvis stikkontakten er løs skal du ikke sette i støpselet.
- Ikke trekk i kabelen for å koble fra produktet. Trekk alltid i selve støpselet.
- Bruk kun korrekte isoleringsenheter: vernebrytere, sikringer (sikringer av skrutypen fjernet fra holderen), jordfeilbrytere og kontaktorer.
- Den elektriske monteringen må ha en isoleringsenhet som lar deg frakoble apparatet fra strømmettet ved alle poler. Isoleringsenheten må ha en kontaktåpningsbredde på minst 3 mm.
- Lukk døren til apparatet helt før du setter støpselet i stikkontakten.
- Produktet leveres med støpsel og strømledning.

2.3 Bruk



ADVARSEL!

Risiko for skade, brannskader og elektrisk støt eller eksplosjon.

- Produktets spesifikasjoner må ikke endres.
- Pass på at ventilasjonsåpningene ikke er blokkerte.
- Ikke la produktet være uten tilsyn mens det er i drift.
- Slå av produktet etter hver bruk.
- Vær forsiktig når du åpner døren til produktet når det er i bruk. Varmluft kan slippe ut.
- Ikke bruk produktet med våte hender eller når det er i kontakt med vann.
- Ikke belast døren når den er åpen.
- Bruk ikke produktet som arbeids- eller oppbevaringsflate.
- Åpne døren til produktet forsiktig. Bruk av ingredienser med alkohol kan føre til en blanding av alkohol og luft.
- Ikke la gnister eller åpne flammer komme i kontakt med produktet når du åpner døren.
- Legg ikke brennbare produkter, eller gjenstander som er fuktet med brennbare produkter, inn i eller i nærheten av apparatet.
- Ikke del Wi-Fi-passordet ditt.



ADVARSEL!

Fare for skade på produktet.

- For å forhindre skade på emaljen:
 - ikke plasser ovnsutstyr eller andre gjenstander direkte i bunnen av produktet.
 - ikke legg aluminiumsfolie direkte på bunnen av rommet i produktet.
 - ikke tøm vann direkte inn i det varme produktet.
 - ikke oppbevar fuktig servise eller mat i produktet når tilberedningen er ferdig.
 - vær forsiktig når du fjerner eller monterer tilbehøret.
- Misfarge på produktets emalje eller rustfritt stål har ingen innvirkning på funksjonen.

SIKKERHETSANVISNINGER

- Bruk en grill-/stekepanne for bløte kaker. Fruktsaft gir permanente flekker.
- Tilbered alltid med produktets dør lukket.
- Hvis produktet er montert bak et møbeldør, må du sørge for at døren aldri er lukket når produktet er i drift. Varme og fuktighet kan bygge seg opp bak et lukket møbeldør og dermed forårsake skade på apparatet, boligen eller gulvet. Ikke lukk møbeldøren før produktet er helt avkjølt etter bruk.

2.4 Stell og rengjøring



ADVARSEL!

Risiko for skade, brann eller skade på produktet.

- Slå av apparatet og trekk støpselet ut av stikkontakten før rengjøring og vedlikehold.
- Påse at produktet er kaldt. Det er fare for at glasspanelene kan knuses.
- Erstatt umiddelbart panelene til glassdørene om disse har blitt skadet. Kontakt det autoriserte servicesenteret.
- Vær forsiktig når du fjerner døren fra produktet. Døren er tung!
- Rengjør apparatet med jevne mellomrom for å forhindre skade på overflaten.
- Rengjør apparatet med en fuktet myk klut. Bruk kun nøytralt vaskemiddel. Bruk ikke slipепrodukter, slipende rengjøringsputer, løsemidler eller metallobjekter.
- Følg sikkerhetsanvisningene på pakken hvis du bruker ovnspray.

2.5 Pyrolytisk rengjøring



ADVARSEL!

Fare for skade / Brann / Kjemiske utslipp (damp) i pyrolytisk modus.

- Før du utfører pyrolytisk rengjøring og innledende forvarming skal du fjerne følgende fra ovnsrommet:
 - eventuelle overflødig matrester, olje eller fett/avleiringer.
 - alle uttakbare gjenstander (inkludert hyller, sideskinner osv. som følger med produktet) spesielt Superclean gryter, panner, brett, redskaper osv.
- Les alle instruksjonene for pyrolytisk rengjøring nøye.
- Hold barn borte fra apparatet mens pyrolytisk rengjøring er i gang. Produktet blir svært varmt og varm luft slippes ut fra ventilasjonsåpningene foran.
- Pyrolytisk rengjøring er en operasjon med høy temperatur som kan frigjøre røyk fra matlagingsrester og konstruksjonsmaterialer, og derfor anbefales forbrukere på det sterkeste å:
 - sørg for god ventilasjon under og etter hver pyrolytiske rengjøring.
 - sørg for god ventilasjon under og etter første forvarming.
- Ikke søl eller påfør vann på ovnsdøren under og etter den pyrolytiske rengjøringen for å unngå å skade glasspanelene.
- Røyk som frigris fra alle pyrolytiske ovner / matrester som beskrevet, er ikke skadelige for mennesker, inkludert barn, eller personer med medisinske tilstander.
- Hold kjæledyr unna produktet under og etter pyrolytisk rengjøring og innledende forvarming. Små kjæledyr (spesielt fugler og reptiler) kan være svært følsomme for temperaturendringer og avgitt røyk.
- Non-stick-overflater på gryter, panner, brett, kjøkkenutstyr osv. kan skades av den høye temperaturen ved pyrolytisk rengjøring av alle pyrolytiske ovner og kan også være en kilde for lave nivåer av skadelige gasser.

2.6 Innvendig lys



ADVARSEL!

Fare for elektrisk støt.

- Angående lampen(e) i dette produktet og reservedeler som selges separat: Disse lampene er ment å motstå ekstreme fysiske forhold i husholdningsprodukter, for eksempel temperatur, vibrasjon, fuktighet, eller er ment å signalisere informasjon om produktets driftsstatus. De er ikke ment å brukes i andre bruksområder og egner seg ikke til rombelysning.
- Dette produktet inneholder en lyskilde med energieffektivitetsklasse G.
- Bruk kun lyspærer med tilsvarende spesifikasjoner.

2.7 Tjenester

- Kontakt det autoriserte servicesenteret for å reparere apparatet.
- Bruk kun originale reservedeler.

2.8 Avfallshåndtering



ADVARSEL!

Fare for skade og kvelning.

- Kontakt kommunen din for informasjon om hvordan du kaster apparatet.
- Koble produktet fra strømmen.
- Kutt av strømkabelen, lukk produktet og kast den.
- Fjern dørlåsen for å forhindre at barn, eller kjæledyr kan bli innestengt i apparatet.

3. PRODUKTBEKRIVELSE

3.1 Generell oversikt

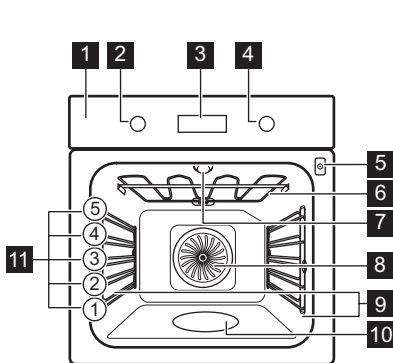

- 1 Betjeningspanel
- 2 Bryter for ovnsfunksjoner
- 3 Display
- 4 Betjeningsbryter
- 5 Kontakt til steketermometer
- 6 Varmeelement
- 7 Lys
- 8 Vifte
- 9 Uttakbare brettstiger
- 10 Gravert ovnsrom
- 11 Hyllenivåer

BETJENINGSPANEL

3.2 Tilbehør

Rist

For kokekar, kakeformer, steker.

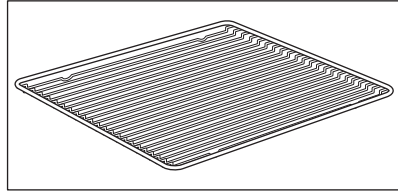

Stekebrett

For kaker og kjeks.

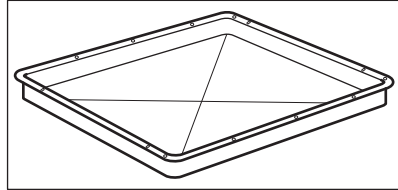

Grill-/stekepanne

For å bake eller steke eller for å samle opp fett.

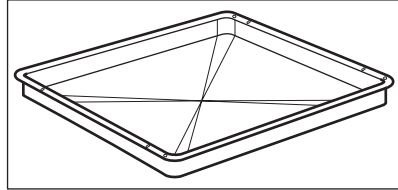

Proffbrett

For rundstykker, saltstenger og småkaker. Egnert for dampfunksjoner. Misfarging av overflaten har ingen effekt på funksjonaliteten.

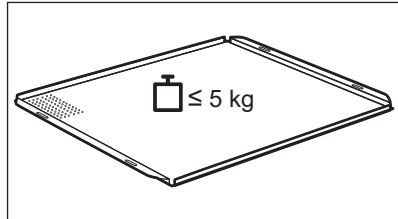

Steketermometer

Måler temperaturen i maten.

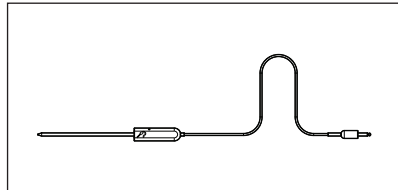







4. BETJENINGSPANEL

4.1 Skjult lås

For å bruke produktet, trykker du på bryteren. Bryteren kommer ut.







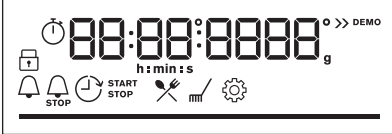



4.2 Oversikt over betjeningspanel

				OK		
Timer	Hurtigoppvarming	Lys	Steketermometer	Bekreft innstilling	Trykk på	Drei bryteren
Velg en ovnsfunksjon for å slå på produktet.						
Vri bryteren for ovnsfunksjoner til av-posisjonen for å slå av ovnen.						



4.3 Display

	Display med nøkkelfunksjoner.
---	-------------------------------

Displayindikatorer

Grunnleggende indikatorer				
 Sperr	 Assistert matlaging	 Rengjøring	 Innstillinger	 Hurtigoppvarming
Timer-indikatorer				
 Varselur	 Sluttid	 Utsatt tid	 Tidsinnstilling	
 Wi-Fi-tilkoblingen er slått på.		 Fjernkontroll er slått på.		
Wi-Fi-indikator – blinker når apparatet kan kobles til Wi-Fi.		Fjernkontroll-indikator – produktet kan fjernstyres.		

FØR FØRSTE GANGS BRUK

Fremdriftslinje – for temperatur eller tid. Linjen er helt rød når ovnen når den innstilte temperaturen.	
Indikator for matlaging med damp	
Steketermometer indikator	





5. FØR FØRSTE GANGS BRUK







ADVARSEL!

Se etter i Sikkerhetskapitlene.

5.1 Første gangs rengjøring

Rengjør den tomme ovnen før første bruk og angi tiden:			
			 00:00 Still inn tiden. Trykk på OK.

5.2 Første gangs forvarming

 Forvarm den tomme ovnen før første gangs bruk.	
Steg 1	Ta ut alt tilbehør og avtakbare brettstiger fra ovnen.
Steg 2	Velg maksimumstemperaturen for funksjonen:  La ovnen stå på i 1 time.
Steg 3	Velg maksimumstemperaturen for funksjonen:  La ovnen stå på i 15 minutter.
 Ovnens kan avgi lukt og røyk under forvarming. Sørg for tilstrekkelig ventilasjon i rommet.	

5.3 Trådløs tilkobling

For å koble til produktet trenger du:

- Trådløst nettverk med internettilkobling.

- Mobilenhet koblet til det samme trådløse nettverket.

Steg 1	Slik laster du ned My Electrolux Kitchen appen: Skann QR-koden på typeskiltet med kameraet på mobilenheten for å bli omdirigert til Electrolux-hjemmesiden. Typeskiltet er plassert på den fremre rammen til produktet. Du kan også laste ned appen direkte fra app store.
Steg 2	Følg appens introduksjonsinstruksjoner.
Steg 3	Vri knappen for varmefunksjonene for å velge:  .
Steg 4	Vri på kontrollbryteren for å velge: Innstillinger. Slå på Wi-Fi. Se kapittelet "Menystruktur".

Frekvens	2,4 GHz WLAN
	2400–2483,5 Mhz
Protokoll	IEEE 802.11 b DSSS, 802.11 g/n OFDM
Maks effekt	EIRP < 20 dBm (100 mW)
Wi-Fi-modul	NIUS-50

5.4 Programvarelisenser

Programvaren i dette produktet inneholder komponenter som er basert på programvarer fra gratis og åpne kilder. Electrolux erkjenner bidragene fra åpne programvare og robotsamfunn til utviklingsprosjektet.

For å få tilgang til kildekoden for disse gratis og åpne programvarekomponentene med lisensvilkår som krever publisering, og for å se deres fullstendige informasjon om opphavsrett og gjeldende lisensvilkår, gå til: <http://electrolux.opensoftwarerepository.com> (mappe NIUS).

6. DAGLIG BRUK



ADVARSEL!



Se etter i Sikkerhetskapitlene.

6.1 Slik stiller du inn: Varmefunksjoner

Steg 1	Vri bryteren for ovnsfunksjoner og velg en ovnsfunksjon.
Steg 2	Vri kontrollbryteren for å sette temperaturen.
 – trykk og hold for å slå på funksjonen: Hurtigoppvarming. Den er ikke tilgjengelig for enkelte ovnsfunksjoner.	

Matlaging med damp



Kontroller at ovnen er kald.







Steg 1	Steg 2	Steg 3	Steg 4
			Forvarm den tomme ovnen i 10 min. for å danne fuktighet. Legg maten i ovnen.
Fyll hulrommet med vann fra springen.	Velg ovnsfunksjonen med damp.	Still inn temperaturen.	
<p>i Hulrommet har maksimal kapasitet på 250 ml. Fyll ikke vann på nytt under matlaging eller når ovnen er varm.</p>			

Når dampkokingen er ferdig:

Steg 1	Steg 2	Steg 3
Vri bryteren for ovnsfunksjonene til av-posisjonen for å slå av ovnen.	Åpne døren forsiktig. Frigitt fuktighet kan forårsake brannskader.	Kontroller at ovnen er kald. Fjern gjenværende vann fra ovnsrommet.

6.2 Varmefunksjoner

Varmefunksjon	Anvendelse
 <p>Ekte Varmluft</p>	Slik baker du på opptil tre hyllnivåer samtidig og tørker mat. Angi temperaturen 20–40 °C lavere enn Over- og undervarme.
 <p>Over- og undervarme</p>	For å bake og steke på ett hyllnivå.
 <p>SteamBake</p>	For å tilføre fuktighet under tilberedningen. For å få riktig farge og sprø skorpe under baking. For å gjenoppvarme mat med saftigere resultater. Hermetisering av frukt eller grønnsaker.

Varmefunksjon	Anvendelse
 Pizzafunksjon	Slik steker du pizza. For å oppnå en mer intens bruning og sprø bunn.
 Undervarme	For å hermetisere mat og bake kaker med sprø bunn.
 Frossen mat	For å gjøre halvfabrikata og hurtigmat (f.eks. pommefrites, potetbåter og vårruller) sprøere.
 Baking med fukt	Denne funksjonen er laget med tanke på å spare energi når man lager mat. Når du bruker denne funksjonen, kan temperaturen i ovnsrommet variere fra den angitte temperaturen. Restvarmen brukes. Varmeeffekten kan reduseres. For mer informasjon, se kapittelet «Daglig bruk», merknader om: Baking med fukt.
 Grill	Slik griller du tynne matstykker og rister brød.
 Gratinerer med vifte	For å steke store kjøttstykker eller fjærfe på én brett plassering. For å gratinere og brune.
 Meny	For å gå inn i Meny: Assistert matlaging, Rengjøring, Innstillinger.



Ekte Varmluft, Over- og undervarme: Når du stiller inn temperaturen under 80 °C, slås lampen automatisk av etter 30 sekunder.

6.3 Merknader om: Baking med fukt

Denne funksjonen blir brukt til å overholde energieffektivitetsklassen og økodesignkrav (i henhold til EU 65/2014 og EU 66/2014). Tester i henhold til:

IEC/EN 60350-1

Stekeovnsdøren skal være lukket under tilberedning slik at funksjonen ikke forstyrres, og ovnen er i drift med høyest mulig energieffektivitet.







Når du bruker denne funksjonen, slås ovnslampen automatisk av etter 30 sekunder.

For matlaginginstruksjonene se kapittelet «Råd og tips» Baking med fukt. For generelle anbefalinger om energisparing se kapittelet «Energieffektivitet», Energisparing.





6.4 Slik stiller du inn: Assistert matlaging

Hver rett i denne undermenyen har en anbefalt ovnsfunksjon og temperatur. Bruk funksjonen til å tilberede en rett raskt med standardinnstillinger. Du kan også justere tiden og temperaturen under matlagingen.









For enkelte av rettene kan du også lage mat med:	Tilberedningsgrad:
<ul style="list-style-type: none"> • Steketermometer 	<ul style="list-style-type: none"> • Rå • Medium – rosa • Godt stekt























Steg 1	Steg 2	Steg 3	Steg 4
 	 	 P1 - P45	 OK
Gå inn i menyen.	Velg Assistert matlaging. Trykk OK .	Velg retten. Trykk på OK .	Sett retten inn i ovnen. Bekreft innstilling.



















6.5 Assistert matlaging

Bildetekst	
	Steketermometer tilgjengelig. Plasser Steketermometer i den tykkeste delen av retten. Stekeovnen slår seg av når den innstilte Steketermometer temperaturen er nådd.
	Vannmengden til dampfunksjonen.
	Forvarm produktet før du starter tilberedningen.
	Brethøyde.















Displayet viser **P** og et **nummer** på retten som du kan kontrollere i tabellen. Når funksjonen er ferdig, kontroller at maten er klar.

	Rett	Vekt	Brethøyde / tilbehør
1	Roastbiff, rå	1 - 1.5 kg; 4–5 cm tykke stykker	 2; stekebrett Stek kjøttet i et par minutter i en varm panne. Sett inn i produktet.
2	Roastbiff, medium		
3	Roastbiff, godt stekt		
4	Biff, medium	180 - 220 g per stykk; 3 cm tykke skiver	  3; stekeform på rist Stek kjøttet i et par minutter i en varm panne. Sett inn i produktet.
5	Oksesstek / brasert (ribbe, rund, tykk flanke)	1.5 - 2 kg	 2; stekeform på rist Stek kjøttet i et par minutter i en varm panne. Tilsett væske. Sett inn i produktet.
6	Roastbiff, rå (langtidssteking)	1 - 1.5 kg; 4–5 cm tykke stykker	 2; stekebrett Bruk favorittkrydderet ditt eller bare salt og nykvernet pepper. Stek kjøttet i et par minutter i en varm panne. Sett inn i produktet.
7	Roastbiff, medium (langtidssteking)		
8	Roastbiff, godt stekt (langtidssteking)		
9	Filet, rå (langtidssteking)	0,5–1,5 kg; 5–6 cm tykke stykker	 2; stekebrett Bruk favorittkrydderet ditt eller bare salt og nykvernet pepper. Stek kjøttet i et par minutter i en varm panne. Sett inn i produktet.
10	Filet, middels (langtidssteking)		
11	Filet, fullført (langtidssteking)		
12	Kalvestek (f.eks. skulder)	0.8 - 1.5 kg; 4 cm tykke stykker	 2; stekeform på rist Bruk favorittkrydderet ditt. Tilsett væske. Stek det tildekket.
13	Svinestek eller skulder	1.5 - 2 kg	 2; stekeform på rist Snu kjøttet etter halve steketiden.

	Rett	Vekt	Brethøyde / tilbehør
14	Pulled pork (langsom tilberedning)	1.5 - 2 kg	  2; stekebrett Bruk favorittkrydderet ditt. Snu kjøttet etter halve tilberedningstiden for å få en jevn stekefarge.
15	Fersk filet	1 - 1.5 kg; 5–6 cm tykke stykker	  2; stekeform på rist Bruk favorittkrydderet ditt.
16	Spareribs	2 - 3 kg; bruk rå, 2–3 cm tykke ribber	 3; langpanne Tilsett væske for å dekke bunnen av en form. Snu kjøttet etter halve steketiden.
17	Lammelår med ben	1.5 - 2 kg; 7–9 cm tykke stykker	  2; stekeform på stekebrett Tilsett væske. Snu kjøttet etter halve steketiden.
18	Hel kylling	1 - 1.5 kg; fersk	  2;  200 ml; gryterett på stekebrett Bruk favorittkrydderet ditt. Snu kyllingen etter halve tilberedningstiden for å få en jevn stekefarge.
19	Halv kylling	0.5 - 0.8 kg	  3; stekebrett Bruk favorittkrydderet ditt.
20	Kyllingbryst	180 - 200 g per stykk	   2; gryterett på rist Bruk favorittkrydderet ditt. Stek kjøttet i et par minutter i en varm panne.
21	Kyllinglår, ferske	-	  3; stekebrett Hvis du marinerer kyllingbein først, angi lavere temperatur og kok dem lenger.
22	Hel and	2 - 3 kg	  2; stekeform på rist Bruk favorittkrydderet ditt. Legg kjøttet på stekebrett. Snu anden etter halve steketiden.
23	Hel gås	4 - 5 kg	  2; langpanne Bruk favorittkrydderet ditt. Legg kjøttet på stekebrettet. Snu gåsen etter halve steketiden.
24	Kjøttpudding	1 kg	  2; rist Bruk favorittkrydderet ditt.





	Rett	Vekt	Bretthøyde / tilbehør
25	Hel fisk, grillet	0.5 - 1 kg per fisk	 2; stekebrett Fyll fisken med smør og bruk favorittkrydder og urter.
26	Fiskefilét	-	 3; gryterett på rist Bruk favorittkrydderet ditt.
27	Ostekake	-	 2;  28 cm rund form på rist
28	Eplekake	-	 2;  100–150 ml; stekebrett
29	Epleterte	-	 2; paiform på rist
30	Eplekake	-	 2;  100–150 ml;  22 cm paiform på rist
31	Brownies	2 kg av deig	 3; langpanne
32	Sjokolademuffins	-	 2;  100–150 ml; muffinsbrett på rist
33	Brødkake	-	 2; loff-form på rist
34	Bakte poteter	1 kg	 2; stekebrett Legg hele poteter med skinn rett på stekebrettet.
35	Kiler	1 kg	 3; stekebrett med bakepapir Bruk favorittkrydderet ditt. Skjær potetene i biter.
36	Stekt blandede grønnsaker	1 - 1.5 kg	 3; stekebrett med bakepapir Bruk favorittkrydderet ditt. Del grønnsakene i stykker.
37	Croquetter, fros- sen	0.5 kg	 3; stekebrett
38	Pommes frites, frossen	0.75 kg	 3; stekebrett

KLOKKEFUNKSJONER

	Rett	Vekt	Breththøyde / tilbehør
39	Kjøtt / grønnsakslasagne med tørre nudeltallerkener	1 - 1.5 kg	 2; gryterett på rist
40	Potetgrateng (råpoteter)	1 - 1.5 kg	 1; gryterett på rist Roter retten etter halve tilberedningstiden.
41	Fersk pizza, tynn	-	  2;  100 ml; stekebrett med bakepapir
42	Pizza fersk, tykk	-	  2; stekebrett med bakepapir
43	Quiche	-	 2; stekeform på rist
44	Baguette / Ciabatta / loff	0.8 kg	  2;  150 ml; stekebrett med bakepapir Det trengs mer tid for loff.
45	Kornet / rugbrød / mørkt brød i brødform	1 kg	  2;  150 ml; stekebrett med bakepapir / rist







7. KLOKKEFUNKSJONER







7.1 Klokkefunksjonene

Klokkefunksjon	Anvendelse
 Varselur	Når tidtakeren er ferdig høres et lydsignal.
 Tilberedningstid	Når tidtakeren er ferdig høres lydsignal og ovnsfunksjonen stopper.
 Utsatt tid	For å utsette starten og/eller slutten på tilberedningen.
 Tidsinnstilling	Maksimaltid er 23 t 59 min. Denne funksjonen har ingen innvirkning på bruk av ovnen. For å slå av og på Tidsinnstilling velg: Meny, Innstillinger.

7.2 Slik stiller du inn: Klokkefunksjonene









Slik angir du: Tid på dagen		
Steg 1	Steg 2	Steg 3
		
For å endre klokkeslett, gå inn i menyen og velg Innstillinger, Klokkeslett.	Still klokken.	Trykk på: OK.

Slik angir du: Varselur			
Steg 1	Displayet viser: 00:00 	Steg 2	Steg 3
			
Trykk på: 		Angi Varselur	Trykk på: OK.
 Timeren starter nedtellingen med det samme.			

Slik angir du: Tilberedningstid				
Steg 1	Steg 2	Displayet viser: 00:00  STOP	Steg 3	Steg 4
				
Velg en ovnsfunksjon og still inn temperaturen.	Trykk gjentatte ganger: 		Still inn tilberedningstiden.	Trykk på: OK.
 Timeren starter nedtellingen med det samme.				

BRUKE TILBEHØRET

Slik angir du: Utsatt tid

Steg 1	Steg 2		Steg 3	Steg 4		Steg 5	Steg 6
		Display- et viser: tid på dagen 			Display- et viser: --- 		
Velg ovns- funk- sjon.	Trykk gjentatte ganger: 	START	Angi starttid.	Trykk på: OK.	STOPP	Angi fer- digtid.	Trykk på: OK.

 Timer startet å telle ned ved innstilt starttid.

8. BRUKE TILBEHØRET



ADVARSEL!

Se etter i Sikkerhetskapitlene.

8.1 Innsetting av tilbehør

Små fordypninger øverst for å øke sikkerheten. Fordypningene er også tippebeskyttet. Den høye kanten rundt risten forhindrer at kokekar sklir av risten.

Rist:

Sett ristene inn mellom sporene på brettstigen.

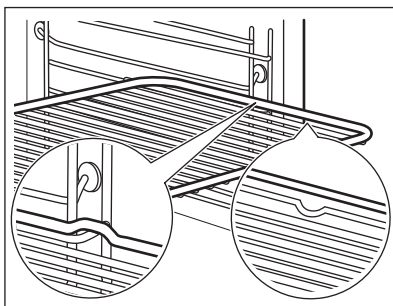

Stekebrett / Langpanne:
Skyv brettet inn i sporene på brettstigene.

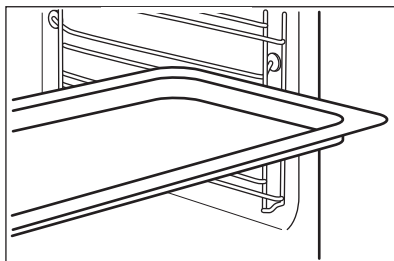

8.2 Steketermometer

Steketermometer – måler temperaturen inne i maten.

To temperaturer må stilles inn:

°C
Ovnstemperaturen.

Kjernetemperaturen.

Slik får du best tilberedningsresultater:

Ingrediensene bør holde
romtemperatur.



Ikke bruk det til flytende
retter.

Det må stå i retten under tilbered-
ningen.

Bruk: Steketermometer



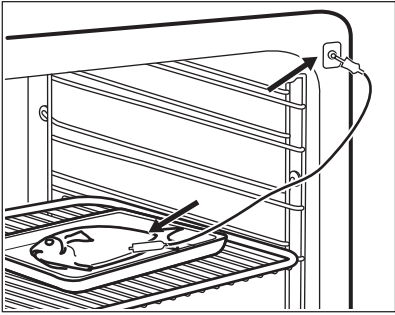
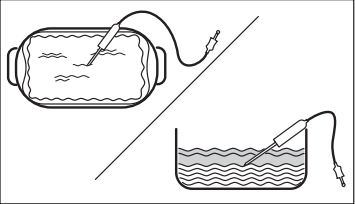



Steg 1	Slå på ovnen.
Steg 2	Angi varmefunksjon og, om nødvendig, ovnstemperatur.
Steg 3	Sett inn: Steketermometer.
Kjøtt, fjærkre og fisk	Gryterett
Sett spissen på Steketermometer inn i midten av kjøttet eller fisken, helst i den tykkeste delen. Sørg for at minst 3/4 av Steketermometer er inne i retten.	Sett spissen på Steketermometer nøyaktig i midten av gryteretten. Steketermometer bør stå stødig på samme sted under steking. For å oppnå dette kan du bruke en solid ingrediens. Bruk kanten av formen som støtte for silikonhåndtaket på Steketermometer. Tuppen av Steketermometer ikke berører bunnen av formen.

TILLEGGSFUNKSJONER

	
Steg 4	Sett Steketermometer i kontakten på fremsiden av ovnen. Displayet viser den aktuelle temperaturen til: Steketermometer.
Steg 5	 – trykk for å angi kjernetemperaturen til sensoren.
Steg 6	OK – trykk for å bekrefte. Når retten når den angitte temperaturen, hører du et lydsignal. Du kan velge å stoppe eller å fortsette tilberedningen for å sikre at maten er godt stekt.
Steg 7	Fjern Steketermometer pluggen fra kontakten og ta retten ut av ovnen. <div data-bbox="213 842 1028 959" style="border: 1px solid black; padding: 5px;"> ADVARSEL! Siden Steketermometer blir svært varm er det en risiko for brannskader. Vær forsiktig når du trekker ut pluggen på sensoren og fjerner den fra maten.</div>



9. TILLEGGSFUNKSJONER

9.1 Sperre

Denne funksjonen forhindrer at produktfunksjonen endres ved et uhell.		
Slå den på når produktet er i gang – den angitte matlagingen fortsetter, betjeningspanelet er låst. Slå den på når produktet er av – den kan ikke slås på, betjeningspanelet er låst.		
 	 OK – trykk og hold for å slå på funksjonen. Det høres et lydsignal.	 OK – trykk og hold inne for å slå den av.
 3 x  – blinker når låsen er slått på.		

9.2 Automatisk utkobling

Av sikkerhetsmessige hensyn slår ovnen seg av etter en viss tid dersom en ovnsfunksjon er i bruk og ingen innstillinger endres.

 (°C)	 (t)
30 - 115	12.5
120 - 195	8.5
200 - 245	5.5
250 – maksimum	3

Automatisk utkobling virker ikke med funksjonene: Lys, Steketermometer, Utsatt tid.

9.3 Kjølevifte

Når produktet er i bruk, slår kjøleviften seg på automatisk for å holde produktets overflater kalde. Hvis du slår av produktet, er kjøleviften aktiv til produktet avkjøles.

9.4 Mekanisk dørlås

Dørlåsen er ulåst når du kjøper ovnen.

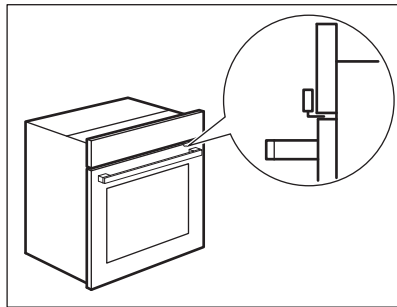

<p> FORSIKTIG! Ikke flytt dørlåsen verti- kalt. Ikke skyv på dørlåsen når du lukker ovnsdøren.</p>	
--	--

9.5 Slik bruker du: Mekanisk dørlås

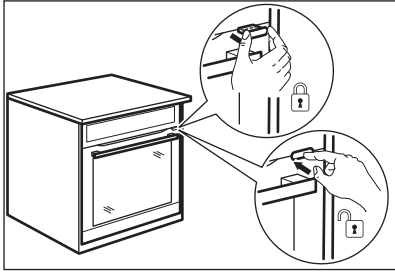
Steg 1	For å låse døren trekker du dørlåsen fremover til den låser seg.
Steg 2	For å låse opp døren skyver du dørlåsen tilbake inn i panelet. 

Slik åpner du den låste døren

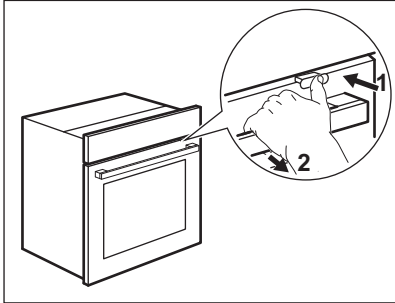
Du kan åpne døren når dørlåsen er låst.	
Steg 1	Skyv litt på dørlåsen og åpne døren ved å trekke i håndtaket. 
Når du lukker døren, må du påse at dørlåsen forblir låst.	

10. RÅD OG TIPS

10.1 Råd om tilberedning





Temperaturer og steketider i tabellene er kun veiledende. De avhenger av oppskriftene og kvalitet og mengde ingredienser som brukes.

Produktet ditt kan muligens bake eller steke på en annen måte enn det gamle produktet ditt gjorde. Antydningene nedenfor viser anbefalte innstillinger for temperatur, tilberedningstid og hylleplassering for spesifikke mattyper.

Hvis du ikke finner opplysningene for en spesiell oppskrift, kan du ta utgangspunkt i en tilsvarende rett.



10.2 Baking med fukt

Følg forslagene i tabellen for best mulig resultater. Bruk den tredje brett plasseringen.

	 (°C)	 (min)
Pastagrøteng	200 - 220	45 - 55
Potetgrøteng	180 - 200	70 - 85
Moussaka	170 - 190	70 - 95
Lasagne	180 - 200	75 - 90
Cannelloni	180 - 200	70 - 85
Brøduppuding	190 - 200	55 - 70
Risuppuding	170 - 190	45 - 60
Eplekake av formkakedeig (rund kakeform)	160 - 170	70 - 80
Loff	190 - 200	55 - 70

10.3 Baking med fukt – anbefalt tilbehør

Bruk mørke og ikke-refleksive bokser og beholderen. De har bedre varmeabsorbering enn den lette fargen og de reflekserne rettene.

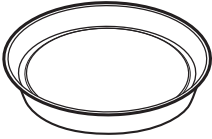



			
Pizzapanne	Kakeform	Ramekins	Form for karamellpudding
Mørk, ikke-reflekterende 28 cm diameter	Mørk, ikke-reflekterende 26 cm diameter	Keramisk 8 cm diameter, 5 cm høyde	Mørk, ikke-reflekterende 28 cm diameter

10.4 Tilberedningstabeller for testinstitutter

Informasjon for testinstitutter





Tester i henhold til: EN 60350, IEC 60350.

Baking i én høyde – baking i former





		 °C	 min	
Fettfritt formkake	Ekte Varmluft	160	45 - 60	2
Fettfritt formkake	Over- og undervarme	160	45 - 60	2
Eplepai, 2 former Ø 20 cm	Ekte Varmluft	160	55 - 65	2
Eplepai, 2 former Ø 20 cm	Over- og undervarme	180	55 - 65	1
Kjeks	Ekte Varmluft	140	25 - 35	2
Kjeks	Over- og undervarme	140	25 - 35	2

Baking i én høyde – kjeks
Bruk det tredje hyllenivået.

STELL OG RENGJØRING





		 °C	 min
Småkaker, 20 stk. per stekebrett, forvarm den tomme ovnen	Ekte Varmluft	150	20 - 30
Småkaker, 20 stk. per stekebrett, forvarm den tomme ovnen	Over- og undervarme	170	20 - 30

Baking i flere høyder – kjeks

		 °C	 min	
Kjeks	Ekte Varmluft	140	25 - 45	2 / 4
Småkaker, 20 stk. per stekebrett, forvarm den tomme ovnen	Ekte Varmluft	150	25 - 35	1 / 4
Fettfritt formkake	Ekte Varmluft	160	45 - 55	2 / 4
Eplepai, 1 boks per rist (Ø 20 cm)	Ekte Varmluft	160	55 - 65	2 / 4

Grill

Forvarm den tomme ovnen i 5 minutter.
Grill med maksimum temperaturinnstilling.

		 min	
Smørbrød	Grill	1 - 2	5
Storfestek, snu halvveis	Grill	24 - 30	4



11. STELL OG RENGJØRING



ADVARSEL!

Se etter i Sikkerhetskapitlene.

11.1 Merknader om rengjøring

 Rengjøringsmidler	Rengjør produktets forside kun med en mikrofiberklut med varmt vann og et mildt vaskemiddel.
	Bruk en rengjøringsløsning for å rengjøre metalloverflater.
	Rengjør flekker med et mildt vaskemiddel.
 Hverdagsbruk	Rengjør ovnsrommet etter bruk. Fettopsamling eller andre rester kan føre til brann.
	Ikke oppbevar maten i produktet lenger enn 20 minutter. Tørk ovnsrommet kun med en mikrofiberklut etter hver bruk.
 Tilbehør	Rengjør alt tilbehør etter hver bruk og la det tørke. Bruk kun en mikrofiberklut med varmt vann og et mildt vaskemiddel. Ikke rengjør tilbehøret i en oppvaskmaskin.
	Rengjør ikke tilbehør med slippbelegg med sterke vaskemidler eller skarpe gjenstander.

11.2 Slik rengjør du: Gravert ovnsrom

Rengjør ovnsrommet for å fjerne kalkrester etter damptilberedning.

Steg 1	Steg 2	Steg 3
Hell 250 ml hvit eddik i ovnsrommet. Bruk maks 6 % eddik uten tilsetningsmidler.	La eddiken løse opp kalkrestene i romtemperatur i 30 minutter.	Rengjør ovnsrommet med varmt vann og en myk klut.
For funksjonen: SteamBake rengjør ovnen for hver 5. – 10. kokesyklus.		

11.3 Slik fjerner du: Gyllestøtter

Fjern brettstignene for å rengjøre ovnen.

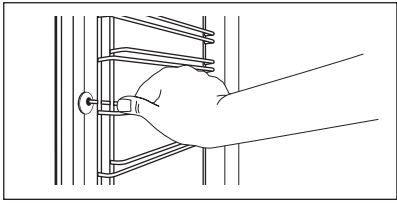
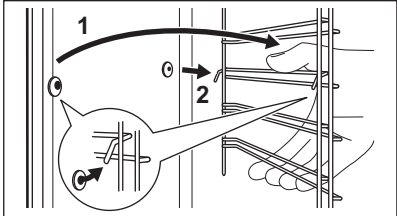
Steg 1	Slå av ovnen og vent til den har kjølt seg ned.	
Steg 2	Trekk den fremre delen av ovnsstigen ut fra sideveggen.	
Steg 3	Trekk den bakre delen av hyllestøtten ut fra sideveggen og ta den ut.	
Steg 4	Monter hyllestøttene i motsatt rekkefølge.	

11.4 Bruk: Pyrolytisk rengjøring

Rengjør ovnen med Pyrolytisk rengjøring.



ADVARSEL!

Fare for brannskader.



FORSIKTIG!

Hvis det er andre produkter montert i samme kabinett må du ikke bruke dem samtidig som denne funksjonen. Dette kan skade ovnen.



Før Pyrolytisk rengjøring:

Slå ovnen av, og vent til den er kald.	Fjern alt tilbehør og alle uttakbare hyllestøtter.	Rengjør ovnsogn og det innvendige dørglasset med varmt vann, en myk klut og et skånsomt vaskemiddel.
--	--	--

Pyrolytisk rengjøring

Steg 1	Gå inn i meny: Rengjøring $\frac{mm}{}$.	
Mulighet	Varighet	
C1 - Lett rengjøring	1 h	
C2 - Normal rengjøring	1 h 30 min	

STELL OG RENGJØRING

Pyrolytisk rengjøring	
C3 - Grundig rengjøring	3 h
Steg 2	OK - trykk for å velge rengjøringsprogrammet.
Steg 3	OK – trykk for å starte rengjøringen.
Steg 4	Etter rengjøring, dreier bryteren for varmefunksjoner til av-posisjonen.
 Når rengjøringen starter, er ovnsdøren låst og lampen er av. Frem til døren låses opp, viser displayet:  .	

Når rengjøringen er over:		
Slå ovnen av, og vent til den er kald.	Rengjør ovnsrommet med en myk klut.	Fjern resten fra bunnen av ovnen.

11.5 Rengjøringspåminnelse

Ovnen påminner deg når den skal rengjøres med pyrolytisk rengjøring.	
 blinker i displayet i 5 sekunder etter hver tilberedningsøkt.	For å slå av påminnelsen, må du taste inn Meny og velg Innstillinger, Rengjøringspåminnelse.

11.6 Slik fjerner og monterer du: Dør

Du kan fjerne døren og det indre glasspanelet for å rengjøre det. Antall glass er forskjellig for ulike modeller.

 ADVARSEL! Døren er tung.

 FORSIKTIG! Hånder glasset forsiktig, særlig på kantene på frontpanelet. Glasset kan knuse.

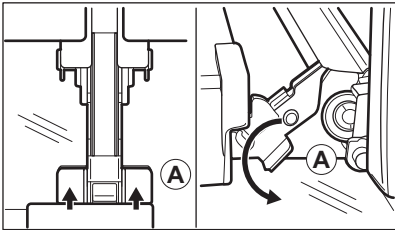
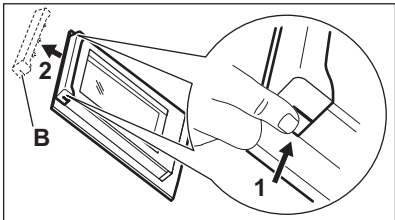
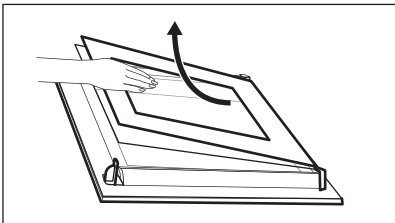
Steg 1	Åpne døren helt.	
Steg 2	Løft og trykk klemmefestene (A) på begge dørhengslene.	
Steg 3	Lukk døren til første åpneposisjon (ved tilnærmet 70° vinkel). Hold ovnsdøren i begge sider og trekk den ut og opp fra ovnen. Legg døren med utsiden ned på et mykt og stabilt underlag.	
Steg 4	Hold dørlisten (B) øverst på døren på begge sider og trykk innover for å frigjøre klipslåsen.	
Steg 5	Trekk dørlisten mot deg for å fjerne den.	
Steg 6	Hold et og et glass øverst i kanten og trekk dem oppover og ut av føringen.	
Steg 7	Rengjør glasspanelet med såpe og vann. Tørk glasspanelet grundig. Ikke rengjør glasspanelene i oppvaskmaskinen.	
Steg 8	Gjenta stegene ovenfor i motsatt rekkefølge etter rengjøring.	
Steg 9	Monter det minste panelet først, så det store, og til slutt døren. Kontroller at glassene er satt inn og ligger i riktig posisjon, ellers kan overflaten på døren overopphetes.	

11.7 Slik bytter du: Ovnslampe



ADVARSEL!

Fare for elektrisk støt.
Lampen kan være varm.

FEILSØKING

Før du skifter pæren:

Steg 1	Steg 2	Steg 3
Slå av ovnen. Vent til ovnen er avkjølt.	Koble fra strømtilførselen til ovnen.	Legg en klut på bunnen i ovnsrommet.

Øverste ovnslampe

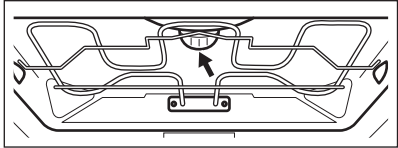
Steg 1	Drei glassdekselet for å ta det av.	
Steg 2	Rengjør glassdekselet.	
Steg 3	Erstatt pæren med en egnet varmebestandig lyspære som tåler 300 °C.	
Steg 4	Monter glassdekselet.	

Sidelampe

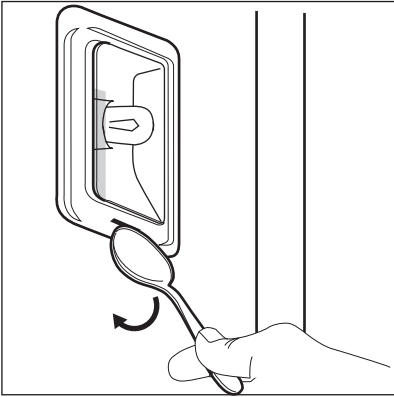
Steg 1	Fjern den venstre hyllestøtten for å nå lampen.	
Steg 2	Bruk en smal, stump gjenstand (f.eks. en teskje) for å fjerne glassdekselet.	
Steg 3	Rengjør glassdekselet.	
Steg 4	Erstatt pæren med en egnet varmebestandig lyspære som tåler 300 °C.	
Steg 5	Monter glassdekselet.	
Steg 6	Monter den venstre hyllestøtten.	

12. FEILSØKING



ADVARSEL!

Se etter i Sikkerhetskapitlene.

12.1 Hva må gjøres, hvis...

tilfeller som ikke er inkludert i denne tabellen, ta kontakt med et autorisert servicesenter.



Produktet ikke slår seg på eller blir ikke oppvarmet

Problem	Kontroller at...
Du kan ikke aktivere eller betjene apparatet.	Apparatet er riktig koblet til strømforsyningen.
Produktet blir ikke varmt.	Den automatiske utkoplingsfunksjonen er deaktivert.
Produktet blir ikke varmt.	Døren til produktet er lukket.
Produktet blir ikke varmt.	Sikringen har gått.
Produktet blir ikke varmt.	Låsen er av.



Komponenter

Problem	Kontroller at...
Lampen er slått av.	Baking med fukt – er slått på.
Lampen fungerer ikke.	Lyspæren har gått.
Steketermometer starter ikke.	Pluggen til Steketermometer er satt helt inn i kontakten.



Feilkoder

Displayet viser ...	Kontroller at...
Err C2	Du trakk Steketermometer -støpslet ut av stikkontakten.
Err C3	Døren er lukket eller dørlåsen er ikke ødelagt.
Err F102	Døren til produktet er lukket.

ENERGIEFFEKTIV



Feilkoder

Err F102

Dørlåsen er ikke ødelagt.

00:00

Det var strømbrudd. Angi tid på dagen.

Hvis displayet viser en feilkode som ikke står i denne tabellen, må du slå sikringene i huset av og på for å starte ovnen på nytt. Hvis feilmeldingen vises igjen, ta kontakt med et autorisert service-senter.



Rengjøring

Problem

Kontroller at...

Vannet lekker ut av ovnen.

Det er for mye vann i ovnen.

12.2 Servicedata

Hvis du ikke greier å løse problemet selv, kontakter du forhandleren eller et autorisert servicesenter.

Du finner informasjon som servicesenteret behøver på typeskiltet. Typeskiltet er plassert på den fremre rammen til produktrommet. Ikke fjern typeskiltet fra produktrommet.

Vi anbefaler at du noterer opplysningene her:

Modell (MOD.)

.....

Produktnummer (PNC)

.....

Serienummer (S.N.)

.....

13. ENERGIEFFEKTIV

13.1 Produktinformasjon og produktinformasjonsark

Leverandørens navn

Electrolux

Modellidentifikasjon

COP827V 944032113
COP827X 944032112
EO82PBK 944032114

Energieffektivitetsindeks	81.2	
Energieffektivitetsklasse	A+	
Energiforbruk med standard matmengde, over- og under-varme	1.09 kWt/syklus	
Energiforbruk med standardbelastning, viftemodus	0.69 kWt/syklus	
Antall ovner	1	
Varmekilde	Elektrisitet	
Volum	71 l	
Ovnstyper	Innebygd ovn	
Masse	COP827V	35.0 kg
	COP827X	35.0 kg
	EO82PBK	35.0 kg

EN 60350-1 - Elektriske husholdningsapparater for matlaging – del 1: Sortiment, ovner, dampovner og griller – metoder for måling av ytelse.

13.2 Energisparing



Produktet har noen funksjoner som hjelper deg å spare energi under vanlig matlaging.

Sørg for at produktets dør er lukket når produktet er i bruk. Ikke åpne produkt døren for ofte under matlaging. Hold dørpakningen ren og sørg for at den sitter godt på plass.

Bruk kokekar i metall for å øke energisparingen.

Når det er mulig skal du ikke forvarme produktet før matlaging.

Hold pausene mellom stekingene så kort som mulig når du lager flere retter om gangen.

Tilberedning med varmluft

Bruk om mulig tilberedningsfunksjoner med varmluft for å spare strøm.

Restvarme

Viften og ovnslampen vil fortsette å fungere. Når du slår av produktet viser skjermen restvarmen. Denne varmen kan du bruke til å holde maten varm.

Når tilberedningstiden er lengre enn 30 min, reduser produktets temperatur til minimum 3 - 10 min før matlagingen avsluttes. Restvarmen inne i produktet fortsetter å tilberede.

Bruk restvarmen til å varme opp andre retter.

Slik holder du maten varm

Hvis du vil bruke restvarmen til å holde måltidet varmt, velg lavest mulig temperaturinnstilling. Displayet viser restvarmeindikatoren eller -temperaturen.

MENYSTRUKTUR

Matlaging med lampen av

Slå av lampen under matlaging. Slå den på kun når du behøver den.







Baking med fukt



Funksjonen er laget med tanke på å spare strøm under matlaging.

Når du bruker denne funksjonen, slås ovnslampen automatisk av etter 30 s. Du kan slå på ovnslampen igjen, men dette reduserer forventet energibesparing.

14. MENYSTRUKTUR

14.1 Meny



Steg 1	Steg 2	Steg 3	Steg 4	Steg 5
				
 – velg for å gå inn i Meny.	Velg alternativet fra Meny strukturen og trykk på OK.	Velg innstillingen.	OK – trykk for å bekrefte innstillingen.	Juster verdien og trykk OK.
Vri bryteren for ovnsfunksjoner til av-posisjonen for å gå ut av Meny.				

Meny struktur		
Assistert matlaging 	Rengjøring 	Innstillinger 

Innstillinger					
01	Tid på dagen	Endre	02	Skjermlysstyrke	1 - 5
03	Tastelyder	1 – Pip 2 – Klikk 3 – Lyd av	04	Summerlyd	1 - 4
05	Steketermometer Handling	1 – Alarm og stopp 2 – Alarm	06	Tidsinnstilling	På/Av
07	Lys	På/Av	08	Hurtigoppvarming	På/Av
09	Rengjøringspåminnel- se	På/Av	10	Wi-Fi	På/Av

Innstillinger					
11	Automatisk fjernkontroll	På/Av	12	Glem nettverk	Ja / Nei
13	Demomodus	Aktiveringskode: 2468	14	Programvareversjon	Kontroller
15	Tilbakestill alle innstillinger	Ja / Nei			

15. BESKYTTELSE AV MILJØET

Resirkuler materialer som er merket med symbolet . Legg emballasjen i riktige beholdere for å resirkulere det. Bidrar til å beskytte miljøet, menneskers helse og for å resirkulere avfall av elektriske og elektroniske produkter. Ikke kast produkter som er merket med symbolet  sammen med husholdningsavfallet. Produktet kan leveres der hvor tilsvarende produkt selges eller på miljøstasjonen i kommunen. Kontakt kommunen for nærmere opplysninger.

VÄLKOMMEN TILL ELECTROLUX! TACK FÖR ATT DU HAR VALT EN AV VÅRA PRODUKTER.



I vår strävan efter hållbarhet minskar vi på mängden papper och tillhandahåller fullständiga användarmanualer via Internet. Sök upp den fullständiga användarmanualen på electrolux.com/manuals



Hämta tips om användning, broschyrer, felsökning, service- och reparationsinformation electrolux.com/support



Ladda ner **My Electrolux Kitchen**-appen för fler recept, tips och felsökning.



INNEHÅLL

1. SÄKERHETSINFORMATION.....	198	6.3 Anvisningar om: Bakning med fukt.....	210
1.1 Säkerhet för barn och personer med funktionsnedsättning.....	198	6.4 Så här ställer du in:	
1.2 Allmän säkerhet.....	198	Assisterad matlagning.....	211
2. SÄKERHETSINSTRUKTIONER.....	200	6.5 Assisterad matlagning.....	211
2.1 Installation.....	200	7. KLOCKFUNKTIONER.....	215
2.2 Elanslutning.....	201	7.1 Klockfunktioner.....	215
2.3 Använd.....	201	7.2	
2.4 Underhåll och rengöring.....	202	Så här ställer du in: Klockfunktioner..	216
2.5 Pyrolytisk rengöring.....	202	8. ANVÄNDNING AV TILLBEHÖR.....	217
2.6 Invändig belysning.....	203	8.1 Sätta in tillbehör.....	217
2.7 Service.....	203	8.2 Matlagningstermometer.....	218
2.8 Avyttring.....	203	9. TILLVALSFUNKTIONER.....	219
3. PRODUKTBESKRIVNING.....	204	9.1 Knapplås.....	219
3.1 Allmän översikt.....	204	9.2 Automatisk avstängning.....	220
3.2 Tillbehör.....	204	9.3 Kylfläkt.....	220
4. KONTROLLPANELEN.....	205	9.4 Mekaniskt lucklås.....	220
4.1 Infällbara vred.....	205	9.5 Så här använder du: Mekaniskt lucklås.....	221
4.2 Översikt av kontrollpanelen.....	205	10. RÅD OCH TIPS.....	222
4.3 Display.....	206	10.1 Tillagningsrekommendationer....	222
5. FÖRE FÖRSTA ANVÄNDNING.....	206	10.2 Bakning med fukt.....	222
5.1 Första rengöring.....	207	10.3 Bakning med fukt - rekommenderade tillbehör.....	222
5.2 Initial föruppvärmning.....	207	10.4 Tillagningstabeller för testinstitut.....	223
5.3 Trådlös anslutning 	207	11. SKÖTSEL OCH RENGÖRING.....	224
5.4 Programvarulicenser.....	208	11.1 Rengöring.....	225
6. DAGLIG ANVÄNDNING.....	208	11.2 Hur man rengör: Fördjupning i ugnsutrymmet.....	225
6.1		11.3 Hur man tar bort: Ugnsstegar ...	225
Så här ställer du in: Tillagningsfunktioner.....	208		
6.2 Tillagningsfunktioner.....	209		

11.4 Så här använder du:	13. ENERGIEFFEKTIVITET	231
Pyrolytisk rengöring.....	13.1 Produktinformation och	
11.5 Påminnelse om rengöring.....	produktinformationsblad.....	231
11.6	13.2 Energibesparing.....	232
Hur man tar bort och installerar: Lucka	14. MENYSTRUKTUR	233
n.....	14.1 Meny.....	233
11.7 Byte av: Lampa.....	15. MILJÖSKYDD	234
12. FELSÖKNING		229
12.1 Vad gör jag om		230
12.2 Servicedata.....		231

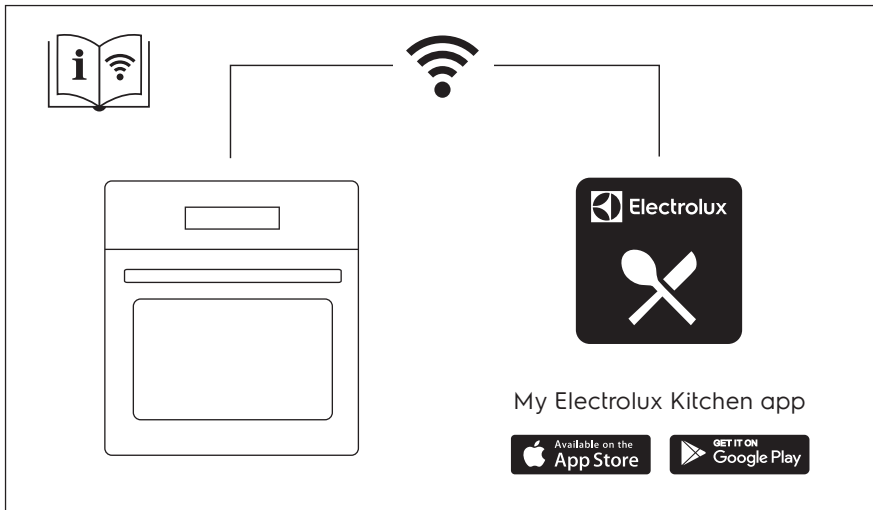

Med reservation för ändringar.

1. ⚠ SÄKERHETSINFORMATION

Läs noga de bifogade instruktionerna före installation och användning av produkten. Tillverkaren är inte ansvarig för eventuella personskador eller andra skador som uppkommit som ett resultat av felaktig installation eller användning. Förvara alltid bruksanvisningen på en säker och tillgänglig plats för framtida bruk.

1.1 Säkerhet för barn och personer med funktionsnedsättning

- Denna produkt kan användas av barn från 8 års ålder och uppåt, och av personer med nedsatt fysisk, sensorisk eller mental förmåga, samt personer med bristande erfarenhet och kunskap om de övervakas eller instrueras om hur produkten används på ett säkert sätt och förstår de risker som är förknippade med användningen. Barn under 8 år eller personer med mycket omfattande och komplexa funktionsnedsättningar ska inte vistas i närheten av produkten utan ständig uppsikt.
- Barn ska hållas under uppsikt så att de inte leker med produkten och mobilenheter med My Electrolux Kitchen .
- Håll allt förpackningsmaterial utom räckhåll för barn och kassera det på lämpligt sätt.
- **WARNING!** Ugnen och åtkomliga delar blir mycket varma under användning. Håll barn och husdjur borta från produkten när den används och när den svalnar.
- Om maskinen har ett barnlås ska den aktiveras.
- Barn får inte utföra rengöring och underhåll av produkten utan uppsikt.

1.2 Allmän säkerhet

- Denna produkt är endast avsedd för matlagning.
- Denna produkt är avsedd för enskilt hushållsbruk inomhus.

- Produkten kan användas i kontor, hotellrum, gårdsgästhus och liknande boenden där sådan användning inte innebär att genomsnittlig hushållsförbrukning överskrids.
- Installation av denna produkt och byte av kabeln får endast utföras av behörig person.
- Använd inte produkten innan den har installerats i inbyggnadsstrukturen.
- Bryt strömförsörjningen till apparaten före utförande av underhåll.
- Om nätsladden är skadad måste den bytas av tillverkaren, tillverkarens auktoriserade servicecenter eller personer med motsvarande utbildning, för att undvika fara.
- **VARNING!** Kontrollera att produkten är avstängd innan du byter lampa för att undvika risk för elektriska stötar.
- **VARNING!** Ugnen och åtkomliga delar blir mycket varma under användning. Var försiktig så att du inte vidrör värmeelementen eller ugnsutrymmet.
- Använd alltid ugnsvantar vid iläggning eller urtagning av tillbehör eller ugnsformar.
- Använd endast matlagningstermometern som rekommenderas för den här produkten.
- För att ta bort en ugnsstege drar du först ut stegen framtill och sedan den bakre delen från sidoväggen. Sätt tillbaka ugnsstegar i omvänd ordning.
- Använd inte ångrengöringsmedel för att rengöra produkten.
- Använd inte skarpa rengöringsmedel med slipeffekt eller vassa metallskrapor för att rengöra luckans glas för att undvika repor, vilka i sin tur kan leda till att glaset spricker.
- Ta bort alla tillbehör från ugnen och avlägsna större avlagringar/spill från utrymmet före pyrolytisk rengöring.

2. SÄKERHETSINSTRUKTIONER

2.1 Installation

**WARNING!**

Endast en behörig person får installera den här produkten.

- Avlägsna allt förpackningsmaterial.
- Installera eller använd inte en skadad produkt.
- Följ installationsinstruktionerna som följer med produkten.
- Var alltid försiktig när produkten rör sig eftersom den är tung. Använd alltid skyddshandskar och täckta skor.
- Dra aldrig produkten i handtaget.
- Installera produkten på en säker och lämplig plats som uppfyller installationskraven.
- Minsta avstånd till andra produkter ska beaktas.
- Kontrollera, före installation av ugnen, att ugnsluckan kan öppnas enkelt utan motstånd.
- Produkten är utrustad med ett elektriskt kylsystem. Den måste användas med den elektriska strömförsörjningen.
- En inbyggnad enhet måste uppfylla stabilitetskraven enligt DIN 68930.

Skåpets minimihöjd (minsta höjd för skåpet under bänk)	578 (600) mm
Skåpets bredd	560 mm
Skåpets djup	550 (550) mm
Höjd på produktens främre del	594 mm
Höjd på produktens bakre del	576 mm
Bredd på produktens främre del	595 mm
Bredd på produktens bakre del	559 mm
Produktens djup	567 mm
Inbyggnadsdjup för produkten	546 mm
Djup med öppen lucka	1027 mm
Minsta storlek på ventilationsöppningen. Öppning placerad nedtill på vänstra sidan	560x20 mm
Nätsladdens längd. Kabeln är placerad i det nedre högra hörnet på baksidan	1500 mm
Monteringskruvar	4x25 mm

2.2 Elanslutning



VARNING!

Risk för brand och elektriska stötar.

- Alla elektriska anslutningar ska göras av en behörig elektriker.
- Produkten måste jordas.
- Se till att de parametrarna på märkskylten överensstämmer med elnätets elektricitet.
- Använd alltid ett korrekt installerat, stötsäkert och jordat eluttag.
- Använd inte grenuttag eller förlängningssladdar.
- Kontrollera så att du inte skadar stickkontakten och nätkabeln. Om produktens nätkabel behöver bytas måste det göras av vårt auktoriserade servicecenter.
- Låt inte nätkablar komma i kontakt med eller komma nära produktens lucka eller nichen nedanför produkten, speciellt inte när den är igång eller om luckan är het.
- Stötskyddet för strömförande och isolerade delar måste fästas på ett sådant sätt att det inte kan tas bort utan verktyg.
- Anslut stickkontakten till eluttaget först vid slutet av installationen. Kontrollera att stickkontakten är åtkomlig efter installationen.
- Anslut inte stickkontakten om vägguttaget sitter löst.
- Dra inte i anslutningssladden för att koppla bort produkten från eluttaget. Ta alltid tag i stickkontakten.
- Använd endast rätt isoleringsenheter: strömbrytare, säkringar (säkringar av skruvtyp tas ur hållaren), jordfelsbrytare och kontaktorer.
- Den elektriska installationen måste ha en isolationsenhet så att du kan koppla från produkten från nätet vid alla poler. Kontaktöppningen på isolationsenheten måste vara minst 3 mm bred.
- Stäng produktens lucka helt innan du ansluter kontakten till eluttaget.
- Denna produkt levereras med en huvudkontakt och en huvudkabel

2.3 Använd



VARNING!

Risk för skador, brännskador, elstötar eller explosion föreligger.

- Ändra inte produktens specifikationer.
- Kontrollera att ventilationsöppningarna inte är blockerade.
- Låt inte produkten stå utan uppsikt under användning.
- Stäng av produkten efter varje användningstillfälle.
- Var försiktig när du öppnar produktens lucka medan produkten är påslagen. Varm luft kan strömma ut.
- Använd inte produkten med våta händer eller när den har kontakt med vatten.
- Tryck inte på den öppna luckan.
- Använd inte produkten som arbets- eller avlastningsyta.
- Öppna luckan försiktigt. Användning av ingredienser med alkohol kan orsaka blandning av alkohol och luft.
- Låt inte gnistor eller öppna lågor komma i kontakt med produkten när du öppnar luckan.
- Placera inte brandfarliga produkter eller föremål som är våta med brandfarliga produkter i, i närheten av eller på produkten.
- Dela inte ditt Wi-Fi-lösenord.

SÄKERHETSINSTRUKTIONER



VARNING!

Risk för skador på produkten föreligger.

- För att förhindra skador eller missfärgning på emaljen:
 - placera inte eldfasta former eller andra föremål direkt på ugsnbotten.
 - lägg inte aluminiumfolie direkt på ugsnbotten.
 - håll inte vatten direkt i den heta produkten.
 - Låt inte fuktiga maträtter eller matvaror stå kvar i produkten när tillagningen är klar.
 - var försiktig när du tar bort eller installerar tillbehören.
- Missfärgning av emaljen eller den rostfria ytan påverkar inte produktens funktion.
- Använd en djup form för mjuka kakor. Fruktjuice kan orsaka fläckar som inte går att ta bort.
- Laga alltid mat med luckan stängd.
- Om produkten installeras bakom en beklädnadspanel, till exempel i ett skåp, se till att skåpsdörren eller panelen aldrig är stängd när produkten används. Värme och fukt kan byggas upp bakom en stängd lucka och orsaka skador på produkten, skåpsmöblerna eller golvet. Stäng inte luckan förrän produkten har svalnat helt efter användning.

2.4 Underhåll och rengöring



VARNING!

Det finns risk för personskador, brand eller skador på produkten.

- Stäng av produkten och koppla bort den från eluttaget före underhåll.
- Se till att produkten har svalnat. Det finns även risk för att glaspanelerna kan spricka.
- Byt omedelbart ut luckans glaspaneler om de är skadade. Kontakta auktoriserat servicecenter.
- Var försiktig när du tar bort luckan. Luckan är tung!
- Rengör produkten regelbundet för att förhindra att ytmaterialet försämras.
- Rengör produkten med en fuktig, mjuk trasa. Använd bara milda rengöringsmedel. Använd inte produkter med slipeffekt, skursvampar, lösningsmedel eller metallföremål.
- Om du använder en ugnssprej ska du följa säkerhetsanvisningarna på förpackningen.

2.5 Pyrolytisk rengöring



VARNING!

Risk för skador / brand / kemiska utsläpp (rök) i Pyrolysläget.

- Innan den katalytiska rengöringen och föruppvärmningen startas ska följande tas bort från ugnen:
 - Eventuella matrester, olje- eller fettspill/avlagringar.
 - alla löstagbara föremål (inklusive hyllor, ugnsstegar osv., som medföljer produkten), särskilt kastruller, pannor, brickor, redskap osv. med non-stick-beläggning.
- Läs noga igenom alla instruktioner för pyrolytisk rengöring.
- Håll barn borta från produkten när pyrolytisk rengöring är igång. Produkten blir mycket varm och varm luft släpps ut från de främre ventilationsöppningarna.
- Pyrolytisk rengöring är en högtemperaturfunktion som kan avge ångor från matrester och byggnadsmaterial, och därför bör användaren:
 - Ombesörja god ventilation under och efter varje pyrolytisk rengöring.
 - ge god ventilation under och efter den första förvärmningen.
- Spill eller applicera inte vatten på ugnsluckan under och efter pyrolytisk rengöring för att undvika att skada glasrutorna.

- Ångor som släpps ut från pyrolysugnar/matlagningsrester är inte skadliga för människor, inte heller för barn och eller personer med olika sjukdomstillstånd.
- Håll små husdjur borta från produkten under och efter pyrolysurengöringen och den initiala föruppvärmningen. Små sällskapsdjur (särskilt fåglar och reptiler) kan vara mycket känsliga för temperaturförändringar och avgivna ångor.
- Teflonbeläggningar på kastruller, stekpannor, brickor, köksredskap osv. kan skadas av den höga temperaturen vid användning av pyrolytisk rengöring i alla pyrolysugnar och kan också vara en källa till skadliga ångor i låg grad.

2.6 Invändig belysning



WARNING!

Risk för elektrisk stöt!

- När det gäller lampan/lamporna i denna produkt och reservlampor som säljs separat: Dessa lampor är avsedda att tåla extrema fysiska förhållanden i hushållsapparater, såsom temperatur, vibration, fuktighet eller är avsedda att signalera information om produktens driftsstatus. De är inte avsedda att användas i andra produkter eller som rumsbelysning i hemmet.
- Denna produkt innehåller en ljuskälla med energieffektivitetsklass G.
- Använd bara lampor med samma specifikationer.

2.7 Service

- Kontakta ett auktoriserat servicecenter för reparation av produkten.
- Använd endast originalreservdelar.

2.8 Avyttring



WARNING!

Risk för kvävning eller skador.

- Kontakta kommunen för information om hur produkten ska kasseras.
- Koppla loss produkten från eluttaget.
- Klipp av elkabeln nära produkten och kassera den.
- Ta bort luckspärren för att förhindra att barn eller husdjur blir instängda i maskinen.

3. PRODUKTBESKRIVNING

3.1 Allmän översikt

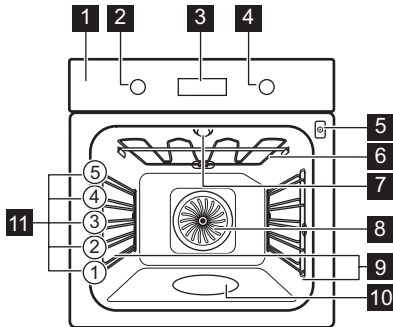

- 1 Kontrollpanel
- 2 Funktionsratt för tillagningsfunktioner
- 3 Display
- 4 Inställningsratt
- 5 Uttag för matlagningstermometern
- 6 Värmelement
- 7 Lampa
- 8 Fläkt
- 9 Ugnsstegar, borttagbara
- 10 Ugnsutrymmets upphöjning
- 11 Hyllplaceringar

3.2 Tillbehör

Galler

För kokkärl, kakformar, stekar.

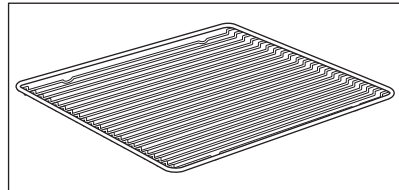

Bakplåt

För kakor och småkakor.

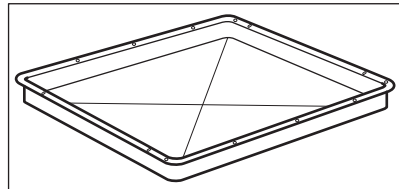

Grill- / stekpanna

För bakning och stekning eller som fettuppsamlingsfat.

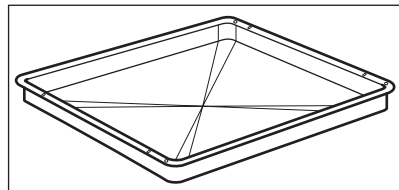

Bakplåt

För småfranska, kringlor och små bakverk.
Lämplig för ångfunktioner. Ytans missfärgning påverkar inte dess funktionsduglighet.

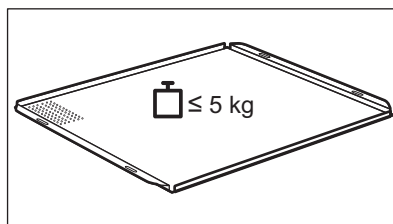

Matlagningstermometer

För att mäta temperaturen inuti maten.

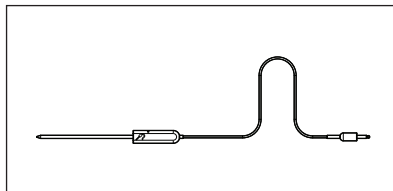

4. KONTROLLPANELEN

4.1 Infällbara vred

För att använda produkten, tryck på kontrollvredet. Vredet kommer ut.

4.2 Översikt av kontrollpanelen







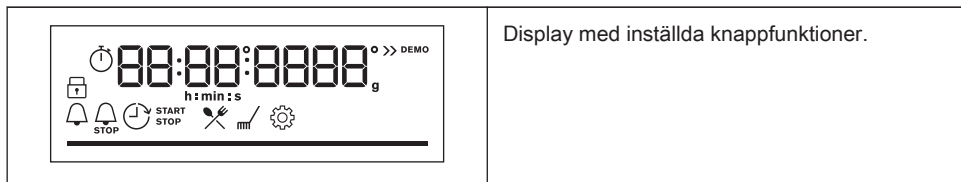







				OK		
Timer	Snabbuppvärmning	Belysning	Matlagningstermometern	Bekräfta inställning.	Tryck på	Vrid ratten
Välj en tillagningsfunktion för att slå på produkten.						
Ugnen stängs av genom att vredet ställs i avstängt läge.						

FÖRE FÖRSTA ANVÄNDNING

4.3 Display



Indikeringar på displayen

Grundläggande indikatorer				
 KnapplåS	 Assisterad matlagning	 Rengöring	 Inställning	 Snabbuppvärmning
Timer-indikatorer				
 Signalur	 Sluttid	 Tidsfördröjning	 Upptimer	
 Wi-Fi-anslutningen är påslagen.		 Fjärrstyrning är påslagen.		
Wi-Fi-indikator - blinkar när ugnen kan anslutas till Wifi-nätverket.		Fjärrstyrning-indikator – produkten kan fjärrstyras..		
Förloppsindikator - visar uppnådd temperatur eller tid. Stapeln är helt röd när ugnen når den inställda temperaturen.				
Indikator för ångtillagning				
Matlagningstermometer Indikator				





5. FÖRE FÖRSTA ANVÄNDNING







VARNING!

Se Säkerhetsavsnitten.

5.1 Första rengöring

Före den första användningen ska den tomma ugnen rengöras och tiden ställas in:			
			 00:00 Ställ in tidtagningen. Tryck på OK.

5.2 Initial föruppvärmning

 Värm upp den tomma ugnen före första användning.	
Steg 1	Ta ut alla tillbehör och flyttbara ugnsstegar ur ugnen.
Steg 2	Ställ in maxtemperatur för funktionen:  Låt ugnen stå på i en timme.
Steg 3	Ställ in maxtemperatur för funktionen:  Låt ugnen stå på i 15 minuter.
 Ugnen kan avge lukt och rök under föruppvärmning. Se till att rummet är ventilerat.	

5.3 Trådlös anslutning

För att ansluta produkten behöver du:

- Trådlöst nätverk med internetanslutning.
- Mobil enhet ansluten till ditt trådlösa nätverk.

Steg 1	Så här laddar du ned My Electrolux Kitchen -appen: Skanna QR-koden på typskylten med kameran på din mobila enhet för att omdirigeras till Electrolux hemsida. Typskylten sitter på ugnsutrymmets främre ram. Du kan också ladda ner appen direkt från App Store.
Steg 2	Följ introduktionsinstruktionerna för appen.
Steg 3	Vrid på vredet för tillagningsfunktioner för att välja:  .
Steg 4	Vrid kontrollvredet för att välja: Inställningar. Slå på Wi-Fi. Se kapitlet "Menystruktur".

DAGLIG ANVÄNDNING

Frekvens	WLAN 2,4 GHz
	2 400–2 483,5 MHz
Protokoll	IEEE 802.11b DSSS, 802.11g/n OFDM
Max. effekt	EIRP <20 dBm (100 mW)
WiFi-modul	NIUS-50

5.4 Programvarulicenser

Programvaran i den här produkten innehåller komponenter som baseras på fri och öppen källkod. Electrolux bekräftar de öppna programvarans och robotgemenskapernas bidrag till utvecklingsprojektet.

För att komma åt källkoden för dessa kostnadsfria och öppna programvarukomponenter vars licensvillkor kräver publicering och för att se deras fullständiga upphovsrättsinformation och tillämpliga licensvillkor, besök: <http://electrolux.opensoftwarerepository.com> (mapp NIUS).

6. DAGLIG ANVÄNDNING



WARNING!

Se Säkerhetsavsnitten.



6.1 Så här ställer du in: Tillagningsfunktioner

Steg 1	Vrid på vredet för tillagningsfunktioner för att välja funktion:
Steg 2	Vrid på kontrollvredet för att justera temperaturen.
 – tryck och håll inne för att aktivera funktionen: Snabbuppvärmning. Tillgänglig för vissa ugnsfunktioner.	

Ångtillagning



Se till att ugnen är kall.







Steg 1	Steg 2	Steg 3	Steg 4
---------------	---------------	---------------	---------------

Ångtillagning			
			Förvärm den tomma ugnen i 10 minuter för att skapa fuktighet. Sätt in maten i ugnen.
Fyll ugnens bottenfördjupning med kranvatten.	Välj ångtillagningsfunktionen.	Ställ in temperaturen.	
<p>i Ugnsutrymmets fördjupning rymmer 250 ml. Fyll inte på ugnens botten när ugnen är påslagen eller medan den fortfarande är varm.</p>			

När ångtillagningen är klar:		
Steg 1	Steg 2	Steg 3
Stäng av ugnen genom att ställa vredet i avstängt läge.	Öppna luckan försiktigt. Ånga som släpps ut kan orsaka brännskador.	Se till att ugnen är kall. Ta bort kvarvarande vatten från ugnsutrymmets fördjupning.

6.2 Tillagningsfunktioner

Tillagningsfunktion	Användning
 Varmluft	För bakning eller torkning på upp till tre ugnsnivåer samtidigt. Välj en temperatur 20 till 40 °C lägre än för Över-/undervärme.
 Över-/undervärme	Bakning och stekning på en ugnsnivå.
 SteamBake	För att tillsätta fukt under tillagningen. För att få den rätta färgen och krispigheten under gräddning. För att få rätten saftigare under uppvärmning. Konservering av frukt eller grönsaker.

Tillagningsfunktion	Användning
 Pizza/Paj	För att tillaga pizza. För att bryna ordentligt och få en knaprig botten.
 Undervärme	För bakning av kakor med knaprig botten och för konservering av livsmedel.
 Frost mat	För tillagning av snabbmat (som pommes frites, klyftpotatis och vårrullar) med en krispig effekt.
 Bakning med fukt	Denna funktion är för att spara energi under tillagningen. När du använder den här funktionen kan temperaturen i ugnen skilja sig från inställd temperatur. Restvärmen används. Värmeeffekten kan minskas. Mer information finns i kapitlet "Daglig användning" och anvisningar om: Bakning med fukt.
 Grill	För grillning av tunnskurna stycken och brödrostning.
 Varmluftsgrillning	Varmluftssteking på första ugnsnivån av större köttstycken eller fågelkött med ben. För att bryna och göra gratänger.
 Meny	Så här öppnar du menyn: Assisterad matlagning, Rengöring, Inställningar.



Varmluft, Över-/undervärme: När du ställer in temperaturen under 80 °C släcks lampan automatiskt efter 30 sekunder.

6.3 Anvisningar om: Bakning med fukt

Denna funktion användes för att uppfylla kraven för energieffektivitet och ekodesigns /enligt EU 65/2014 och EU 66/2014). Tester enligt:

IEC/EN 60350-1

Ugnsluckan ska vara stängd under tillagningen så att funktionen inte avbryts och ugnen fungerar med högsta möjliga energieffektivitet.





Om du använder den här funktionen släcks lampan automatiskt efter 30 sekunder.

För tillagningsinstruktioner, se kapitlet "Råd och tips" Bakning med fukt. För instruktioner om allmän energibesparing, se kapitlet "Energieffektivitet", energibesparing.





6.4 Så här ställer du in: Assisterad matlagning

Varje maträtt i denna undermeny har en föreslagen tillagningsfunktion och temperatur. Använd funktionen för att tillaga en maträtt snabbt med standardinställningar. Tiden och temperaturen kan justeras under tillagningen.

För vissa maträtter kan tillagningen också styras med:	Till vilken grad maträtten ska tillagas:
<ul style="list-style-type: none"> Matlagningstermometer 	<ul style="list-style-type: none"> Rare Medium Well Done















Steg 1	Steg 2	Steg 3	Steg 4
			
Öppna menyn.	Välj Assisterad matlagning. Tryck på OK .	Välj maträtt. Tryck på OK .	Sätt in maträtten i ugnen. Bekräfta inställning.





6.5 Assisterad matlagning

Teckenförklaring	
	Matlagningstermometer tillgängligt. Placera Matlagningstermometer i den tjockaste delen av rätten. Ugnen stängs av när inställd Matlagningstermometer temperatur har uppnåtts.
	Mängden vatten för ångfunktionen.
	Förvärm ugnen innan du börjar laga mat.
	Ugnsnivå.

















Displayen visar **P** och ett **antal** maträtter som du kan kontrollera i tabellen. När funktionen har avslutats, kontrollera om maten är klar.

DAGLIG ANVÄNDNING

	Maträtt	Vikt	Ugnsnivå / tillbehör
1	Rostbiff, röd	1 - 1.5 kg; 4-5 cm tjocka bitar	  2; bakplåt Stek köttet i några minuter i en het stekpanna. Sätt in i ugnen.
2	Rostbiff, medium		
3	Rostbiff, välstekt		
4	Stek, medium	180 - 220 g per bit; 3 cm tjocka skivor	   3; stekfat på galler Stek köttet i några minuter i en het stekpanna. Sätt in i ugnen.
5	Rostbiff/bräserverad (revbensspjäll, rund, tjock flé)	1.5 - 2 kg	  2; stekfat på galler Stek köttet i några minuter i en het stekpanna. Tillsätt vätska. Sätt in i ugnen.
6	Rostbiff, röd (långsam tillagning)	1 - 1.5 kg; 4-5 cm tjocka bitar	  2; bakplåt Använd dina favoritkryddor eller bara salt och färsk malen peppar. Stek köttet i några minuter i en het stekpanna. Sätt in i ugnen.
7	Rostbiff, medium (långsam tillagning)		
8	Rostbiff, välstekt (långsam tillagning)		
9	Filé, röd (långsam tillagning)	0,5-1,5kg; 5-6 cm tjocka bitar	  2; bakplåt Använd dina favoritkryddor eller bara salt och färsk malen peppar. Stek köttet i några minuter i en het stekpanna. Sätt in i ugnen.
10	Filé, medium (långsam tillagning)		
11	Filé, klar (långsam tillagning)		
12	Kalvstek (t.ex. bog)	0.8 - 1.5 kg; 4 cm tjocka bitar	  2; stekfat på galler Använd dina favoritkryddor. Tillsätt vätska. Täckt stek.
13	Fläskstek, hals eller bog	1.5 - 2 kg	 2; stekfat på galler Vänd köttet efter halva tillagningstiden.

	Maträtt	Vikt	Ugnsnivå / tillbehör
14	Pulled pork (långsam tillagning)	1.5 - 2 kg	  2; bakplåt Använd dina favoritkryddor. Vänd köttet efter halva tillagningstiden för att få en jämn bryning.
15	Karré, färsk	1 - 1.5 kg; 5-6 cm tjocka bitar	  2; stekfat på galler Använd dina favoritkryddor.
16	Revbensspjäll	2 - 3 kg; använd råa, 2-3 cm tunna revbensspjäll	 3 långpanna Tillsätt vätska så att botten täcks i stekfatet. Vänd köttet efter halva tillagningstiden.
17	Lammfiol med ben	1.5 - 2 kg; 7-9 cm tjocka bitar	  2; stekfat på galler Tillsätt vätska. Vänd köttet efter halva tillagningstiden.
18	Hel kyckling	1 - 1.5 kg; färsk	  2;  200 ml; stekgryta på plåt Använd dina favoritkryddor. Vänd köttet efter halva tillagningstiden för att få en jämn bryning.
19	Halv kyckling	0.5 - 0.8 kg	  3; bakplåt Använd dina favoritkryddor.
20	Kycklingbröst	180 - 200 g per styck	   2; stekgryta på galler Använd dina favoritkryddor. Stek köttet i några minuter i en het stekpanna.
21	Kycklinglår, färsk	-	  3; bakplåt Om du har marinerat kycklingbenen, välj en lägre temperatur och längre tillagningstid.
22	Hel anka	2 - 3 kg	  2; stekfat på galler Använd dina favoritkryddor. Lägg köttet på stekfatet. Vänd köttet efter halva tillagningstiden.
23	Hel gås	4 - 5 kg	  2; långpanna Använd dina favoritkryddor. Lägg köttet på en djup bakplåt. Vänd gåsen efter halva tillagningstiden.
24	Köttfärslimpa	1 kg	  2; galler Använd dina favoritkryddor.

DAGLIG ANVÄNDNING

	Maträtt	Vikt	Ugnsnivå / tillbehör
25	Hel fisk grillad	0.5 - 1 kg per fisk	  2; bakplåt Fyll fisken med smör och använd dina favoritkryddor och örter.
26	Fiskfilé	-	  3; stekgryta på galler Använd dina favoritkryddor.
27	Cheesecake	-	 2; ∅ 28 cm springform på galler
28	Äppelkaka	-	 2; 🍷 100–150 ml bakplåt
29	Äppelpaj	-	 2; pajform på galler
30	Äppelpaj	-	 2; 🍷 100–150 ml; ∅ 22 cm pajform på galler
31	Brownies	2 kg av deg	 3; långpanna
32	Chokladmuffins	-	 2; 🍷 100–150 ml; muffinsbricka på galler
33	Limpkaka	-	 2; brödform på galler
34	Bakad potatis	1 kg	 2; bakplåt Lägg hela potatisar med skal på bakplåten.
35	Klyftor	1 kg	 3 bakplåt täckt med bakplåtspapper Använd dina favoritkryddor. Skär potatisen i bitar.
36	Grillade grönsaker	1 - 1.5 kg	 3 bakplåt täckt med bakplåtspapper Använd dina favoritkryddor. Skär grönsakerna i bitar.
37	Croquettes, frysta	0.5 kg	 3; bakplåt
38	Pommes frites, frysta	0.75 kg	 3; bakplåt



	Maträtt	Vikt	Ugnsnivå / tillbehör
39	Kött / grönsaks-lasagne med torra plattor	1 - 1.5 kg	2; stekgryta på galler
40	Potatisgratäng (rå potatis)	1 - 1.5 kg	1; stekgryta på galler Vänd rätten efter halva tillagningstiden.
41	Färsk pizza, tunn	-	2; 100 ml; bakplåt täckt med bakplåtspapper
42	Färsk pizza, tunn	-	2; bakplåt täckt med bakplåtspapper
43	Quiche	-	2; bakform på galler
44	Baguette/ciabatta/ljust bröd	0.8 kg	2; 150 ml; bakplåt täckt med bakplåtspapper Mer tid behövs för ljust bröd.
45	Blandkorn/rågbröd/mörkt blandkornsbröd i form	1 kg	2; 150 ml; bakplåt täckt med bakplåtspapper / galler







7. KLOCKFUNKTIONER







7.1 Klockfunktioner

Klockfunktion	Program
 Signalur	När den inställda tiden har gått ges en ljudsignal.
 Tillagningstid	När den inställda tiden har gått ges en ljudsignal och tillagningsfunktionen stoppas.
 Tidsfördröjning	För att fördröja tillagningens start- och/eller sluttid.
 Upptimer	Maximalt är 23 tim 59 min. Denna funktion påverkar inte ugnens funktioner i övrigt. Slå på och stäng av Upptimer genom att välja: Meny, Inställningar.

7.2 Så här ställer du in: Klockslag

Så här ställer du in: Klockslag		
Steg 1	Steg 2	Steg 3
		
Ändra tidpunkt genom att öppna menyn och välja Inställningar och Tid.	Ställ tiden	Tryck på: OK.

Så här ställer du in: Signalur			
Steg 1	Displayen visar: 0:00 	Steg 2	Steg 3
			
Tryck på: 		Ställ in Signalur	Tryck på: OK.
 Timern startar nedräkningen omedelbart.			

Så här ställer du in: Tillagningstid				
Steg 1	Steg 2	Displayen visar: 0:00  STOP	Steg 3	Steg 4
				
Välj en tillagningsfunktion och ställ in temperaturen.	Tryck upprepade gånger på: 		Ställ in tillagningstiden.	Tryck på: OK.
 Timern startar nedräkningen omedelbart.				

Så här ställer du in: Tidsfördröjning

Steg 1	Steg 2		Steg 3	Steg 4		Steg 5	Steg 6
		Dis- playen visar: tidpunkt			Dis- playen visar: --- ⌚		
Välj till- ag- nings- funk- tion.	Tryck upp- repade gångar på: ⌚.	⌚ START	Ställ in startti- den.	Tryck på: OK.	STOPP	Ställ in sluttiden.	Tryck på: OK.

 Timern börjar nedräkningen vid inställd starttid.

8. ANVÄNDNING AV TILLBEHÖR



VARNING!

Se Säkerhetsavsnitten.

8.1 Sätta in tillbehör

Liten inbuktning upptill ökar säkerheten. Fördjupningarna är för också enheterna tippssäkra. Den höga kanten runt hyllan hindrar att kokkärlet glider av.

Galler:

Skjut in gallret mellan ugnstegens ledskenor.

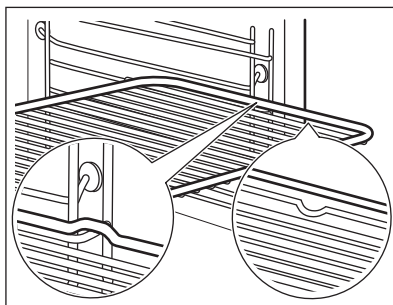

Bakplåt / Djup form:

Skjut in långpannan mellan ungsstegarnas ledskenor.

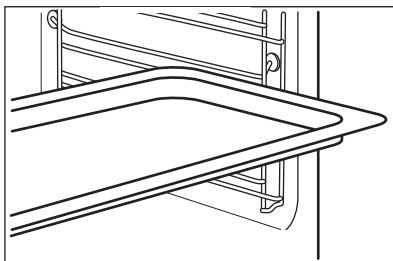

8.2 Matlagningstermometer

Matlagningstermometer- mäter temperaturen inuti maten.

Två temperaturer ska ställas in:

°C
Ugnstemperaturen.

Tillagningstemperaturen.

För bästa resultat:

Ingredienserna ska hålla rumstemperatur.



Den är inte lämplig för flytande rätter.

Under tillagning ska den vara inuti maten.

Så här använder du: Matlagningstermometer

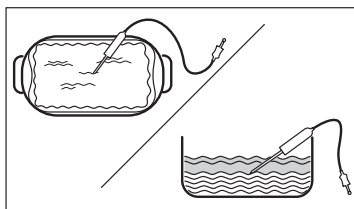
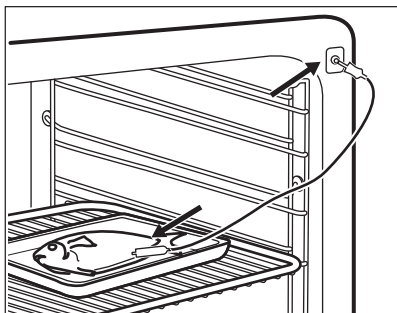



Steg 1	Slå på ugnen.
Steg 2	Ställ in en tillagningsfunktion och, vid behov, ugnstemperatur.
Steg 3	Sätt in: Matlagningstermometer.
Kött, fågel och fisk	Gryta
Sätt i spetsen på Matlagningstermometer i mitten av köttet eller fisken eller i den tjockaste delen. Se till att minst 3/4 av Matlagningstermometer är instucken.	Placera spetsen på Matlagningstermometer mitt i ugnsrätten. Matlagningstermometer ska sitta stabil på samma ställe under tillagningen. Sätt den i en massiv del av maten. Använd kanten på formen som stöd för silikonhandtaget på Matlagningstermometer. Spetsen på Matlagningstermometer får inte komma i kontakt med formens botten.



Steg 4	Anslut Matlagningstermometer i uttaget framtill i ugnen. På displayen visas aktuell temperatur för: Matlagningstermometer.
Steg 5	 - tryck för att ställa in tillagningstemperaturen.
Steg 6	OK – tryck för att bekräfta. En ljudsignal avges när maten når den inställda temperaturen. Du kan välja att stoppa eller fortsätta tillagningen för maten ska bli tillräckligt tillagad.
Steg 7	Dra ut Matlagningstermometer ur uttaget och ta ut maten ur ugnen. <div style="border: 1px solid black; padding: 5px; margin-top: 10px;">  WARNING! Det finns risk för brännskador när Matlagningstermometer blir het. Var försiktig när du drar ut den från kontakten och från maten. </div>



9. TILLVALSFUNKTIONER

9.1 Knapplås

Funktionen förhindrar att ugnsfunktionen ändras oavsiktligt.		
Sätt på den när ugnen är igång – den angivna matlagningen fortsätter, kontrollpanelen är låst. Slå på den när ugnen är avstängd – den kan inte slås på, kontrollpanelen är låst.		
	 OK – tryck och håll inne för att slå på funktionen. En ljudsignal hörs.	 OK – tryck och håll inne för att stänga av den.
 3 x  – blinkar när låset slås på.		

9.2 Automatisk avstängning

Av säkerhetsskäl stängs ugnen av efter en tid om en uppvärmningsfunktion är aktiv och inga inställningar ändras.

 (°C)	 (tim)
30 - 115	12.5
120 - 195	8.5
200 - 245	5.5
250 - maximalt	3

Automatisk avstängning fungerar inte med funktionerna: Belysning, Matlagningstermometer, Tidsfördröjning.

9.3 Kylfläkt

När ugnen är på, slås fläkten på automatiskt för att hålla ugnens ytor svala. Om du stänger av ugnen fortsätter fläkten att gå tills ugnen svalnat.

9.4 Mekaniskt lucklås

Luckan är olåst vid leverans.

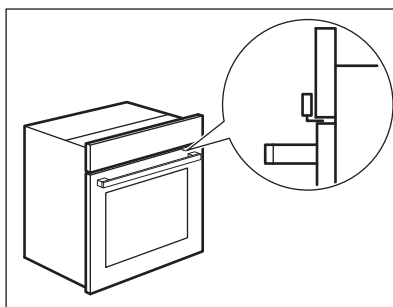

<p>⚠ FÖRSIKTIGHET! Flytta inte lucklåset vertikalt. Tryck inte på lucklåset när du stänger ugnsluckan.</p>	
---	--

9.5 Så här använder du: Mekaniskt lucklås

Steg 1	Lås luckan genom att dra lucklåset framåt tills det låses på plats.
Steg 2	Lås upp luckan genom att trycka tillbaka lucklåset i panelen.

Öppna den låsta luckan

Du kan öppna luckan när lucklåset är låst.

Steg 1	Tryck på lucklåset något och öppna luckan genom att dra i den med handtaget.
När du stänger luckan, se till att lucklåset är låst.	

10. RÅD OCH TIPS



10.1 Tillagningsrekommendationer



Temperatur och tillagningstid i tabellerna är endast riktvärden. Hur de ska väljas beror på recept och ingrediensernas kvalitet och mängd. Ugnen kan baka eller steka annorlunda än din gamla ugn. Tabellerna nedan visar rekommenderade inställningar för temperatur, tillagningstid och hyllposition för specifika typer av mat. Om du inte kan hitta inställningarna för ett visst recept kanske du kan använda inställningarna för ett liknande recept.



10.2 Bakning med fukt

För bästa resultat ska du följa förslagen som listas i tabellen nedan. Använd den tredje hyllnivån.

	 (°C)	 (min.)
Pastagrätäng	200 - 220	45 - 55
Potatisgrätäng	180 - 200	70 - 85
Moussaka	170 - 190	70 - 95
Lasagne	180 - 200	75 - 90
Cannelloni	180 - 200	70 - 85
Brödpudding	190 - 200	55 - 70
Risgrynspudding	170 - 190	45 - 60
Äppelkaka på sockerkakssmet (rund kakform)	160 - 170	70 - 80
Franskbröd	190 - 200	55 - 70

10.3 Bakning med fukt - rekommenderade tillbehör

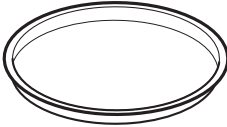
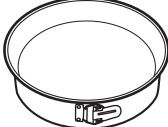



Använd mörka och icke reflekterande burkar och formar. De absorberar värme bättre än ljusa färger och reflektiva formar.

			
Pizzaform	Ugnform	Portionsformar	Tårtbottenform
Mörk, icke reflekterande 28 cm diameter	Mörk, icke reflekterande 26 cm diameter	Keramik 8 cm diameter, 5 cm hög	Mörk, icke reflekterande 28 cm diameter





10.4 Tillagningstabeller för testinstitut

Information för testinstitut





Tester enligt: EN 60350, IEC 60350.
Bakning på en nivå – bakning i formar

		 °C	 min	
Sockerkaka utan fett	Varmluft	160	45 - 60	2
Sockerkaka utan fett	Över-/undervärme	160	45 - 60	2
Äppelpaj, 2 st 20 cm formar	Varmluft	160	55 - 65	2
Äppelpaj, 2 st 20 cm formar	Över-/undervärme	180	55 - 65	1
Mördegskakor	Varmluft	140	25 - 35	2
Mördegskakor	Över-/undervärme	140	25 - 35	2





Bakning på en nivå – kex
Använd den tredje hyllpositionen.

		 °C	 min
Småkakor, 20 st/plåt, förvärm den tomma ugnen	Varmluft	150	20 - 30

SKÖTSEL OCH RENGÖRING

		 °C	 min
Småkakor, 20 st/plåt, förvärm den tomma ugnen	Över-/undervärme	170	20 - 30





Bakning på flera nivåer – kex

		 °C	 min	
Mördegskakor	Varmluft	140	25 - 45	2 / 4
Småkakor, 20 st/plåt, förvärm den tomma ugnen	Varmluft	150	25 - 35	1 / 4
Sockerkaka utan fett	Varmluft	160	45 - 55	2 / 4
Äppelpaj, 1 burk per galler (Ø 20 cm)	Varmluft	160	55 - 65	2 / 4

Grill

Förvärm den tomma ugnen i 5 minuter.

Grillning med maximal temperaturinställning.

		 min	
Rostat bröd	Grill	1 - 2	5
Nötstek, vänd efter halva tiden	Grill	24 - 30	4



11. SKÖTSEL OCH RENGÖRING



VARNING!

Se Säkerhetsavsnitten.

11.1 Rengöring

 <p>Rengöringsmedel</p>	Rengör ugnens framsida med en mikrofiberduk med varmt vatten och ett mildt rengöringsmedel.
	Använd en rengöringslösning för att rengöra metalldelar.
	Rengör fläckar med ett mildt diskmedel.
 <p>För användning varje dag</p>	Rengör ugnsutrymmet efter varje användningstillfälle. Fettansamling eller andra matrester kan leda till brand.
	Låt inte maten stå i ugnen längre än 20 minuter. Torka ugnsutrymmet med enbart en mikrofiberduk efter varje användning.
 <p>Tillbehör</p>	Rengör alla tillbehör efter varje användningstillfälle och låt dem torka. Använd enbart en mikrofiberduk med varmt vatten och ett mildt rengöringsmedel. Diska inte tillbehören i diskmaskin.
	Använd inte rengöringsmedel med slipeffekt eller vassa föremål när du rengör SuperClean-tillbehören.

11.2 Hur man rengör: Fördjupning i ugnsutrymmet

Rengör nedsänkningen i ugnsutrymmet från kalkavlagringar efter tillagning med ånga.

Steg 1	Steg 2	Steg 3
Häll 250 ml vitvinsvinäger i ugnsutrymmets nedsänkning. Använd högst 6 % vinäger utan tillsatser.	Låt vinägern lösa upp kalkavlagringarna i omgivningstemperatur under 30 minuter.	Rengör nedsänkningen med varmt vatten och en mjuk trasa.
För funktionen: SteamBake rengör ugnen efter 5–10 användningar.		

11.3 Hur man tar bort: Ugnsstegar

Ta bort ugnsstegarna vid rengöring av ugnen.

SKÖTSEL OCH RENGÖRING

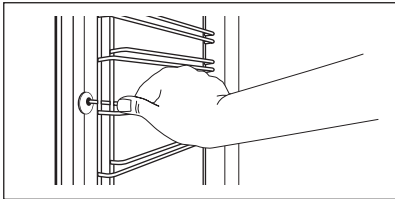
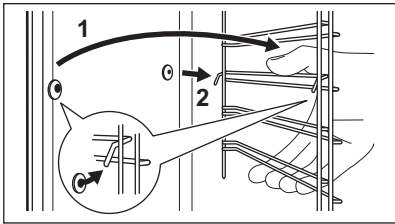
Steg 1	Stäng av ugnen och vänta tills den har svalnat.	
Steg 2	Dra först ut stegarnas främre del från sidoväggen.	
Steg 3	Dra den bakre änden av ugnsstegen bort från sidoväggen och ta bort den.	
Steg 4	Sätt tillbaka ugnsstegar i omvänd ordning.	

11.4 Så här använder du: Pyrolytisk rengöring

Rengör ugnen med Pyrolytisk rengöring.



VARNING!

Det finns risk för brännskador.



FÖRSIKTIGHET!



Om andra produkter är monterade i samma skåp får de inte användas samtidigt som den här funktionen. Det kan skada ugnen.

Före Pyrolytisk rengöring:

Stäng av ugnen och vänta tills den har svalnat.	Ta ut alla tillbehör och borttagbara stöd.	Rengör ugnsbotten och innerglaset på luckan med varmt vatten, mjuk trasa och mildt rengöringsmedel.
---	--	---

Pyrolytisk rengöring

Steg 1	Öppna meny: Rengöring  .	
	Funktion	Koktid
	C1 - Lätt rengöring	1 h
	C2 - Normal rengöring	1 h 30 min

Pyrolytisk rengöring	
C3 - Grundlig rengöring	3 h
Steg 2	OK - tryck för att välja rengöringsprogrammet.
Steg 3	OK – tryck för att starta rengöringen.
Steg 4	Efter rengöring, vrid på vredet för värmefunktioner till avstängt läge.
<p> När rengöringen startar låses ugnsluckan och lampan släcks. Tills luckan låses upp visar displayen: .</p>	



När rengöringen är klar:		
Stäng av ugnen och vänta tills den har svalnat.	Torka ur ugnen invändigt med en mjuk trasa.	Ta bort rester från ugnens botten.

11.5 Påminnelse om rengöring

Ugnen påminner dig om när den ska rengöras med pyrolytisk rengöring.	
 blinkar på displayen i 5 sekunder efter varje tillagning.	För att stänga av påminnelsen, ange Meny och välj Inställningar, Påminnelse om rengöring.

11.6 Hur man tar bort och installerar: Luckan

Man kan ta loss och rengöra luckan och de inre glasrutorna. Antalet glaspaneler skiljer sig åt för olika modeller.

	VARNING! Luckan är tung.
	FÖRSIKTIGHET! Hantera glaset varsamt, särskilt runt den främre panelens kanter. Glaset kan gå sönder.

SKÖTSEL OCH RENGÖRING

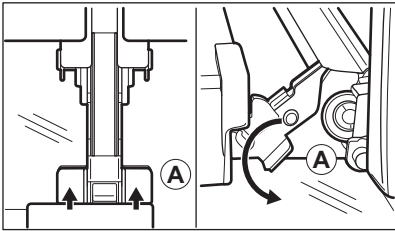
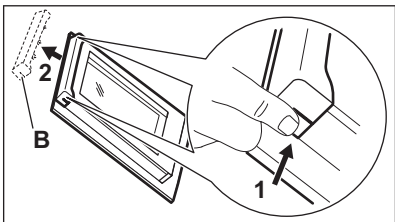
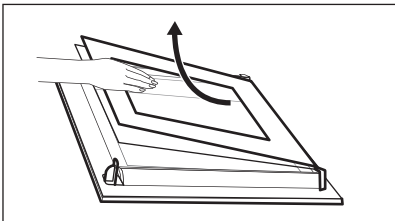
Steg 1	Öppna luckan helt.	
Steg 2	Lyft och tryck in klämspärarna (A) på de två gångjärnen till luckan.	
Steg 3	Stäng ugnsluckan till den första öppna positionen (ungefär 70° vinkel). Håll i luckan på båda sidorna och dra den ut från ugnen i en uppåtående vinkel. Lägg ner luckan med utsidan neråt på en mjuk handduk på ett stabilt underlag.	
Steg 4	Ta tag i lucklisten (B) på båda sidorna av luckans övre kant och tryck inåt för att frigöra klämlåset.	
Steg 5	Dra lucklisten framåt för att ta bort den.	
Steg 6	Håll glaset i överkanten ett i taget och dra dem uppåt och ut ur skenan.	
Steg 7	Rengör glaset med vatten och tvål. Torka luckglaset nogga. Diska inte glasskivorna i diskmaskin.	
Steg 8	Efter rengöring, utför stegen ovan i omvänd ordning.	
Steg 9	Sätt in det mindre ugnsglaset först, därefter det större och sist luckan. Se till att glaset är korrekt och ordentligt införda, annars kan luckans yta bli överhettad.	

11.7 Byte av: Lampa



WARNING!

Risk för elektrisk stöt!
Lampan kan vara het.

Innan du byter lampan:

Steg 1	Steg 2	Steg 3
Stäng av ugnen. Vänta tills ugnen är kall.	Koppla bort ugnen från eluttaget.	Lägg en trasa i botten av ugnsutrymmet.

Övre lampa

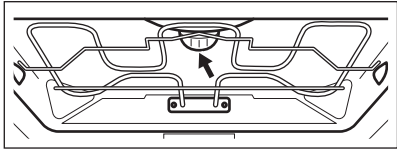
Steg 1	Ta bort glasskyddet genom att vrida på det.	
Steg 2	Rengör glasskyddet.	
Steg 3	Byt ut lampan mot en passande som är värmetålig upp till 300 °C.	
Steg 4	Sätt tillbaka glasskyddet.	

Sidolampa

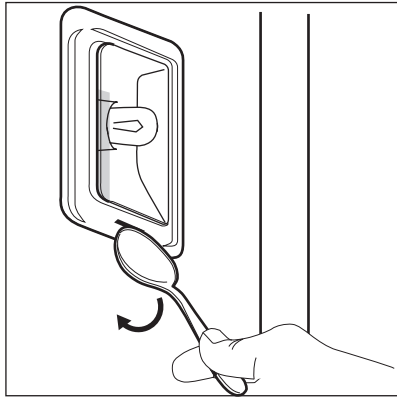
Steg 1	Avlägsna det vänstra hyllstödet för att komma åt lampan.	
Steg 2	Använd ett smalt, trubbigt föremål (t.ex. en tesked) för att ta bort glasskyddet.	
Steg 3	Rengör glasskyddet.	
Steg 4	Byt ut lampan mot en passande som är värmetålig upp till 300 °C.	
Steg 5	Sätt tillbaka glasskyddet.	
Steg 6	Montera det vänstra hyllstödet.	

12. FELSÖKNING





WARNING!
Se Säkerhetsavsnitten.

12.1 Vad gör jag om ...

Om något saknas i denna tabell, kontakta ett auktoriserat servicecenter.

 Ugnen slås inte på eller värms inte upp	
Problem	Kontrollera att...
Det går inte att starta eller använda produkten.	Produkten är korrekt ansluten till eluttaget.
Produkten värms inte upp.	Den automatiska avstängningen är avaktiverad.
Produkten värms inte upp.	Produktens lucka är stängd.
Produkten värms inte upp.	Säkringen har inte löst ut.
Produkten värms inte upp.	Låset är avstängt.

 Komponenter	
Problem	Kontrollera att...
Belysningen är släckt.	Bakning med fukt - är påslagen.
Belysningen fungerar inte.	Glödlampan är trasig.
Funktionen Matlagningstermometer fungerar inte.	Kontakten till Matlagningstermometer är ordentligt isatt i uttaget.

 Felkoder	
Displayen visar ...	Kontrollera att...
Err C2	Matlagningstermometer kontakten har tagits bort från uttaget.
Err C3	Ugnsluckan är stängd och ugnslåset är inte trasigt.
Err F102	Produktens lucka är stängd.

**Felkoder**

Err F102

Ugnslåset är inte trasigt.

00:00

Ett strömavbrott har inträffat. Ställ in klockan.

Om displayen visar en felkod som inte finns i den här tabellen, slå av säkringen och slå på den igen för att starta om ugnen. Om felkoden återkommer, kontakta en auktoriserad serviceverkstad.

**Rengöring****Problem****Kontrollera att...**

Vattnet rinner ut ur bottenfördjupningen.

Det är för mycket vatten i bottenfördjupningen.

12.2 Servicedata

Kontakta din återförsäljare eller en auktoriserad serviceverkstad om du inte kan avhjälpa felet. Nödvändig information som servicecentret behöver finns på graderingsskylten. Typskylten sitter på ugnsutrymmets främre ram. Avlägsna inte typskylten från ugnsutrymmet.

Vi rekommenderar att du antecknar uppgifterna här:

Modell (MOD.)

.....

Produktnummer (PNC)

.....

Serienummer (S.N.)

.....

13. ENERGIEFFEKTIVITET

13.1 Produktinformation och produktinformationsblad

Leverantörens namn	Electrolux
Modellidentifiering	COP827V 944032113 COP827X 944032112 EO82PBK 944032114
Energieffektivitetsindex	81.2

ENERGIEFFEKTIVITET

Energieffektivitetsklass	A+	
Energiförbrukning med standardbelastning, konventionellt läge	1.09 kWh/cykel	
Energiförbrukning med standardbelastning, varmluftsläge	0.69 kWh/cykel	
Antal kaviteter	1	
Värmekälla	Elektricitet	
Volym	71 l	
Typ av ugn	Inbyggd ugn	
Massa	COP827V	35.0 kg
	COP827X	35.0 kg
	EO82PBK	35.0 kg

IEC/EN 60350-1 - Elektriska hushållsapparater för matlagning - Del 1: Sortiment, ugnar, ångugnar och grillar - metoder för att mäta prestanda.

13.2 Energibesparing



Denna produkt har funktioner som låter dig spara energi under vanlig matlagning.

Kontrollera att ugnsluckan är ordentligt stängd när ugnen är påslagen. Öppna inte ugnsluckan för ofta under tillagningen. Håll luckans tätninglist är ren och kontrollera att den sitter rätt och ordentligt fast.

Använd kokkärl i metall för högre energieffektivitet.

Om möjligt, undvik att förvärma ugnen före tillagning.

Gör så korta uppehåll som möjligt vid tillagning av flera rätter för samma tillfälle.

Tillagning med varmluft

Om möjligt, använd varmluftsfunktionen för att spara energi.

Restvärme

Fläkten och belysningen fortsätter att vara påslagna. När du stänger av ugnen visas restvärme på displayen. Du kan använda den värmen för varmhållning.

Om tillagningen tar längre tid än 30 minuter, sänk ugnstemperaturen med minst 3–10 minuter innan tillagningen avslutas. Tillagningen fortsätter med ugnens restvärme.

Använd restvärmen för att värma annan mat.

Varmhållning

Välj lägsta möjliga temperaturinställning för att använda restvärme och hålla maten varm.

Restvärmeindikatorn eller temperaturen visas på displayen.

Laga mat med släckt belysning

Släck belysningen under tillagning. Tänd den endast när du behöver den.







Bakning med fukt



Denna funktion används för att spara energi under tillagningen.

Med denna funktion släcks belysningen automatiskt efter 30 sekunder. Du kan tända belysningen igen, men det innebär att förväntad energibesparing minskar.

14. MENYSTRUKTUR

14.1 Meny

Steg 1	Steg 2	Steg 3	Steg 4	Steg 5
				
 - välj för att öppna Meny.	Välj alternativet i Meny strukturen och tryck på OK.	Välj inställningen.	OK – tryck för att bekräfta inställningen.	Justera värdet och tryck på OK.
Vrid på vredet för tillagningsfunktioner till Meny.				



Meny-struktur		
Assisterad matlagning 	Rengöring 	Inställningar 

Inställningar					
01	Klockslag	Ändra	02	Ljusstyrka i display	1 - 5
03	Knappljud	1 - Pip 2 - Klick 3 - Ljud av	04	Ljudvolym knappar	1 - 4
05	Matlagningstermometer Åtgärd	1 - Larm och stopp 2 - Larm	06	Upptimer	På/Av
07	Belysning	På/Av	08	Snabbuppvärmning	På/Av
09	Påminnelse om rengöring	På/Av	10	Wi-Fi	På/Av
11	Automatisk fjärrstyrning	På/Av	12	Glöm nätverk	Ja/Nej

Inställningar

13	Demoläge	Aktiveringskod: 2468	14	Programversion	Kontrollera
15	Återställ alla inställningar	Ja/Nej			

15. MILJÖSKYDD

Återvinn material med symbolen . Återvinn förpackningen genom att placera den i lämpligt kärl. Bidra till att skydda vår miljö och vår hälsa genom att återvinna avfall från elektriska och elektroniska produkter. Släng inte produkter märkta med symbolen  med hushållsavfallet. Lämna in produkten på närmaste återvinningsstation eller kontakta kommunkontoret.

www.electrolux.com/shop



867380192-A-522022

