

Refrigerator

User manual (freezer only)

RZ40*/RZ70*/RZ80*

Free Standing Appliance

SAMSUNG

Contents

Safety information	4
Important safety symbols and precautions:	5
Severe warning signs for transportation and site	6
Critical installation warnings	6
Installation cautions	8
Critical usage warnings	8
Usage warning	10
Usage cautions	11
Cleaning cautions	12
Critical disposal warnings	12
Additional tips for proper usage	13
Saving Energy Tips	14
This appliance is intended to be used in household and similar applications such as	14
Instructions about the WEEE	15
Installation	16
Refrigerator at a glance	16
Step-by-step installation	17
Operations	24
Main panel	24
SmartThings (applicable models only)	29
Auto Open Door function (applicable models only)	32
Special features	33
Maintenance	36
Door reversal	36
Auto Open Door option touch sensor reversible (applicable models only)	46
Reversing the door handle position (applicable models only)	47
Handle and care	49
Cleaning	50
Replacement	51
Troubleshooting	52
General	52
Do you hear abnormal sounds from the refrigerator?	55
SmartThings (applicable models only)	57

Appendix	58
Safety Instruction	58
Install Instruction	58
Temperature Instruction	59
Information for model and ordering spare parts	62
Open Source Announcement	63

Safety information

- Before using your new Samsung Refrigerator, please read this manual thoroughly to ensure that you know how to operate the features and functions that your new appliance offers safely and efficiently.
- This appliance is not intended for use by persons (including children) with reduced physical, sensory, or mental capabilities, or those who lack experience and knowledge, unless they have been given supervision or instruction concerning the use of the appliance by a person responsible for their safety.
- This appliance can be used by children aged from 8 years and above and persons with reduced physical, sensory or mental capabilities or lack of experience and knowledge if they have been given supervision or instruction concerning use of the appliance in a safe way and understand the hazards involved. Children shall not play with the appliance. Cleaning and user maintenance shall not be made by children without supervision. Children aged from 3 to 8 years are allowed to load and unload refrigerating appliances.
- Warnings and Important Safety Instructions in this manual do not cover all possible conditions and situations that may occur.
It is your responsibility to use common sense, caution, and care when installing, maintaining, and operating your appliance.
- Because these following operating instructions cover various models, the characteristics of your refrigerator may differ slightly from those described in this manual and not all warning signs may be applicable. If you have any questions or concerns, contact your nearest service center or find help and information online at www.samsung.com.
- In order to avoid the creation of a flammable gas-air mixture if a leak in the refrigerating circuit occurs, the size of the room in which the appliance may be sited depends on the amount of refrigerant used.
- Never start up an appliance showing any signs of damage. If in doubt, consult your dealer. The room must be 1 m³ in size for every 8 g of R-600a refrigerant inside the appliance. The amount of refrigerant in your particular appliance is shown on the identification plate inside the appliance.
- Refrigerant squirting out of the pipes could ignite or cause an eye injury. When refrigerant leaks from the pipe, avoid any naked flames and move anything flammable away from the product and ventilate the room immediately.
 - Failing to do so may result in fire or explosion.
- It is hazardous for anyone other than an Authorised Service Person to service this appliance.
- Do not store explosive substances such as aerosol cans with a flammable propellant in this appliance.
- To avoid contamination of food, please respect the following instructions:
 - Opening the door for long periods can cause a significant increase of the temperature in the compartments of the appliance.
 - Clean regularly surfaces that can come in contact with food and accessible drainage systems.
 - Clean water tanks if they have not been used for 48 h; flush the water system connected to a water supply if water has not been drawn for 5 days.
 - Store raw meat and fish in suitable containers in the refrigerator, so that it is not in contact with or drip onto other food.
 - Two-star frozen-food compartments are suitable for storing pre-frozen food, storing or making icecream and making ice cubes.
 - One-, two- and three-star compartments are not suitable for the freezing of fresh food.

-
- If the refrigerating appliance is left empty for long periods, switch off, defrost, clean, dry, and leave the door open to prevent mould developing within the appliance.



Warning; Risk of fire / flammable materials

Important safety symbols and precautions:

Please follow all safety instructions in this manual. This manual uses the following safety symbols.



WARNING

Hazards or unsafe practices that may result in **severe personal injury, property damage, and/or death.**



CAUTION

Hazards or unsafe practices that may result in **severe personal injury and/or property damage.**



NOTE

Useful information that helps users understand or benefit from the refrigerator.

These warning signs are here to prevent injury to you and others.

Please follow them carefully.

After reading this section, keep it in a safe place for future reference.

Safety information

Severe warning signs for transportation and site

WARNING

- When transporting and installing the appliance, care should be taken to ensure that no parts of the refrigerating circuit are damaged.
 - Refrigerant leaking from the pipe work could ignite or cause an eye injury. If a leak is detected, avoid any naked flames or potential sources of ignition and air the room in which the appliance is standing for several minutes.
 - This appliance contains a small amount of isobutane refrigerant (R-600a), a natural gas with high environmental compatibility that is, however, also combustible. When transporting and installing the appliance, care should be taken to ensure that no parts of the refrigerating circuit are damaged.

Critical installation warnings

WARNING

- Do not install the refrigerator in a damp location or place where it may come in contact with water.
 - Deteriorated insulation on electrical parts may cause an electric shock or fire.
- Do not place this refrigerator in direct sunlight or expose it to the heat from stoves, room heaters, or other appliances.
- Do not plug several appliances into the same multiple power strip. The refrigerator should always be plugged into its own individual electrical outlet which has a voltage rating that matches the voltage listed on the refrigerator's rating plate.
 - This provides the best performance and also prevents overloading of house wiring circuits, which could cause a fire hazard from overheated wires.
- If the wall socket is loose, do not insert the power plug.
 - There is a risk of electric shock or fire.
- Do not use a power cord that has cracks or abrasion damage along its length or at either end.
- Do not bend the power cord excessively or place heavy objects on it.
- Do not pull or excessively bend the power cord.
- Do not twist or tie the power cord.
- Do not hook the power cord over a metal object, place a heavy object on the power cord, insert the power cord between objects, or push the power cord into the space behind the appliance.
- When moving the refrigerator, be careful not to roll over or damage the power cord.
 - This may result in an electric shock or fire.
- Never unplug your refrigerator by pulling on the power cord. Always grip the plug firmly and pull straight out from the outlet.
 - Damage to the cord may cause a short-circuit, fire, and/or electric shock.
- Do not store explosive substances such as aerosol cans with a flammable propellant in this appliance.

-
- Do not install this appliance near a heater or inflammable material.
 - Do not install this appliance in a location where gas may leak.
 - This may result in an electric shock or fire.
 - This refrigerator must be properly located and installed in accordance with the instructions in this manual before you use it.
 - Connect the power plug in the proper position with the cord hanging down.
 - If you connect the power plug upside down, the wire can get cut off and cause a fire or electric shock.
 - Make sure that the power plug is not crushed or damaged by the back of the refrigerator.
 - Keep the packing materials out of reach of children.
 - There is a risk of death from suffocation if a child puts the packing materials on his or her head.
 - The appliance must be positioned so that the plug is accessible after installation.
 - Failing to do so may result in an electric shock or fire due to electric leakage.
 - Do not install this appliance in a humid, oily or dusty location, in a location exposed to direct sunlight and water (rain drops).
 - Deteriorated insulation of electrical parts may cause an electric shock or fire.
 - If any dust or water is in the refrigerator, pull out power plug and contact your Samsung Electronics service center.
 - Otherwise there is a risk of fire.
 - Do not stand on top of the appliance or place objects (such as laundry, lighted candles, lighted cigarettes, dishes, chemicals, metal objects, etc.) on the appliance.
 - This may result in an electric shock, fire, problems with the product, or injury.
 - You need to remove all the protective plastic film before you initially plug the product in.
 - The refrigerator must be safely grounded.
 - Always make sure that you have grounded the refrigerator before attempting to investigate or repair any part of the appliance. Power leakages can cause severe electric shock.
 - Never use gas pipes, telephone lines, or other potential lightning attractors as an electrical ground.
 - You must ground the refrigerator to prevent any power leakages or electric shocks caused by current leakage from the refrigerator.
 - This may result in an electric shock, fire, explosion, or problems with the product.
 - Plug the power plug into the wall socket firmly. Do not use a damaged power plug, damaged power cord, or loose wall socket.
 - This may result in an electric shock or fire.
 - If the power cord is damaged, have it replaced immediately by the manufacturer or one of its service agents.
 - The fuse on the refrigerator must be changed by a qualified technician or service company.
 - Failing to do so may result in an electric shock or personal injury.
 - When positioning the appliance, ensure the supply cord is not trapped or damaged.
 - Do not locate multiple portable socket-outlets or portable power supplies at the rear of the appliance.

Safety information

Installation cautions

CAUTION

- Allow sufficient space around the refrigerator and install it on a flat surface.
 - Keep the ventilation space in the appliance enclosure or mounting structure clear of obstructions.
- Allow the appliance to stand for 2 hours before loading foods after installation and turning on.
- We strongly recommend you have a qualified technician or service company install the refrigerator.
 - Failing to do so may result in an electric shock, fire, explosion, problems with the product, or injury.
- Overload on any one door may fell the refrigerator, causing physical injury.

Critical usage warnings

WARNING

- Do not insert the power plug into a wall socket with wet hands.
 - This may result in an electric shock.
- Do not store articles on the top of the appliance.
 - When you open or close the door, the articles may fall and cause personal injury and/or material damage.
- Do not insert hands, feet or metal objects (such as chopsticks, etc.) into the bottom or the back of the refrigerator.
 - This may result in an electric shock or injury.
 - Any sharp edges may cause a personal injury.
- Do not touch the inside walls of the freezer or products stored in the freezer with wet hands.
 - This may cause frostbite.
- Do not put a container filled with water on the refrigerator.
 - If spilled, there is a risk of fire or electric shock.
- Do not keep volatile or flammable objects or substances (benzene, thinner, propane gas, alcohol, ether, LP gas, and other such products) in the refrigerator.
 - This refrigerator is for storing food only.
 - This may result in fire or explosion.
- Children should be supervised to ensure that they do not play with the appliance.
 - Keep fingers out of “pinch point” areas. Clearances between the doors and cabinet are necessarily small. Be careful when you open the doors if children are in the area.
- Do not let children hang on the door or door bins. A serious injury may occur.
- Do not let children go inside the refrigerator. They could become trapped.
- Do not insert your hands into the bottom area under the appliance.
 - Any sharp edges may cause personal injury.

-
- Do not store pharmaceutical products, scientific materials, or temperature sensitive products in the refrigerator.
 - Products that require strict temperature controls must not be stored in the refrigerator.
 - Do not place or use electrical appliance inside the refrigerator/freezer, unless they are of a type recommended by the manufacturer.
 - If you smell pharmaceutical or smoke, pull out power plug immediately and contact your Samsung Electronics service center.
 - If any dust or water is in Refrigerator, pull out power plug and contact your Samsung Electronics service center.
 - Otherwise there is a risk of fire.
 - Do not let children step on a drawer.
 - The drawer may break and cause them to slip.
 - Do not leave the doors of the refrigerator open while the refrigerator is unattended and do not let children enter inside the refrigerator.
 - Do not allow babies or children go inside the drawer.
 - It can cause death from suffocation by entrapment or personal injury.
 - Do not overfill the refrigerator with food.
 - When you open the door, an item may fall out and cause personal injury or material damage.
 - Do not spray volatile material such as insecticide onto the surface of the appliance.
 - As well as being harmful to humans, it may also result in an electric shock, fire, or problems with the product.
 - Do not use or place any substances sensitive to temperature such as flammable sprays, flammable objects, dry ice, medicine, or chemicals near or inside of the refrigerator.
 - Do not use a hair dryer to dry the inside of the refrigerator. Do not place a lighted candle in the refrigerator for removing bad odours.
 - This may result in an electric shock or fire.
 - Do not stand on top of the appliance or place objects (such as laundry, lighted candles, lighted cigarettes, dishes, chemicals, metal objects, etc.) on the appliance. This may result in an electric shock, fire, problems with the product, or injury. Do not put a container filled with water on the appliance.
 - If spilled, there is a risk of fire or electric shock.
 - Do not use mechanical devices or any other means to accelerate the defrosting process, other than those recommended by the manufacturer.
 - Do not damage the refrigerant circuit.
 - Never stare directly at the UV LED lamp for long periods of time.
 - This may result in eye strain due to the ultraviolet rays.
 - Do not put freezer shelf in upside down. Shelf stopper could not work.
 - It may cause a personal injury because of glass shelf drop.
 - Keep fingers out of "pinch point" areas. Clearances between the doors and cabinet are necessarily small. Be careful when you open the doors if children are in the area.
 - If a gas leak is detected, avoid any naked flames or potential sources of ignition, and air the room in which the appliance is standing for several minutes.
 - Do not touch the appliance or power cord.
 - Do not use a ventilating fan.
 - A spark may result in explosion or fire.
 - Use only the LED Lamps provided by the manufacturer or its service agents.

Safety information

- Bottles should be stored tightly together so that they do not fall out.
- This product is intended only for the storage of food in a domestic environment.
- Do not attempt to repair, disassemble, or modify the refrigerator yourself.
 - Unauthorized modifications can cause safety problems. To reverse an unauthorized modification, we will charge the full cost of parts and labor.
- Do not use any fuse (such as cooper, steel wire, etc.) other than a standard fuse.
- If your refrigerator needs to be repaired or reinstalled, contact your nearest service center.
 - Failing to do so may result in an electric shock, fire, problems with the product, or injury.
- If the interior or exterior LED lamp has gone out, contact your nearest service center.
- If the refrigerator emits a burning smell or smoke, unplug the refrigerator immediately and contact your Samsung Electronics service center.
 - Failing to do so may result in an electric or fire hazards.
- Pull the power plug out of the socket before changing the interior lamps of the refrigerator.
 - Otherwise, there is a risk of electric shock.
- If you experience difficulty changing a non-LED light, contact a Samsung service center.
- If the product is equipped with LED lamps, do not disassemble the Lamp Covers and LED lamps yourself.
 - Contact a Samsung service center.
- Plug the power plug into the wall socket firmly.
- Do not use a damaged power plug, damaged power cord or loose wall socket.
 - This may result in an electric shock or fire.

Usage warning

WARNING

- Keep ventilation openings, in the appliance enclosure or in the built-in structure, clear of obstruction.
- Do not use mechanical devices or other means to accelerate the defrosting process, other than those recommended by the manufacturer.
- Do not damage the refrigerant circuit.
- Do not use electrical appliances inside the food storage compartments of the appliance, unless they are of the type recommended by the manufacturer.

Usage cautions

CAUTION

- Do not re-freeze frozen foods that have thawed completely. Do not place carbonated or fizzy drinks in the freezer compartment. Do not put bottles or glass containers in the freezer.
 - When the contents freeze, the glass may break and cause personal injury.
- To get the best performance from the product:
 - Do not place food too close to the vents at the rear of the refrigerator as this can obstruct free air circulation in the refrigerator compartment.
 - Wrap food up properly or place it in airtight containers before putting it into the refrigerator.
 - Do not place glass bottles or carbonated beverages into the freezer. They can freeze and break. Broken beverage containers can cause injury.
 - Please observe maximum storage times and expiration dates of frozen goods.
- Do not place glass or bottles or carbonated beverages into the freezer.
 - The container may freeze and break, and this may result in injury.
- Do not place carbonated or fizzy drinks in the freezer compartment. Do not put bottles or glass containers in the freezer.
 - When the contents freeze, the glass may break and cause personal injury and property damage.
- Service Warranty and Modification.
 - Any changes or modifications performed by a 3rd party on this finished appliance are not covered under Samsung warranty service, nor is Samsung responsible for safety issues that result from 3rd party modifications.
- Do not block the air vents inside the refrigerator.
 - If the air vents are blocked, especially with a plastic bag, the refrigerator can be over cooled.
- Wipe excess moisture from the inside and leave the doors open.
 - Otherwise, odor and mold may develop.
- If the refrigerator is disconnected from the power supply, you should wait for at least five minutes before plugging it back in.
- When the refrigerator got wet by water, pull out the power plug and contact your Samsung Electronics service center.
- Do not strike or apply excessive force to any glass surface.
 - Broken glass may result in a personal injury and/or property damage.
- Be careful that your fingers are not caught in.
- If the refrigerator is flooded, make sure to contact your nearest service center.
 - There is a risk of electric shock or fire.

Safety information

Cleaning cautions

CAUTION

- Do not spray water directly on the inside or outside the refrigerator.
 - There is a risk of fire or electric shock.
- Do not use a hair dryer to dry the inside of the refrigerator.
- Do not place a lighted candle in the refrigerator to remove bad odors.
 - This may result in an electric shock or fire.
- Do not spray cleaning products directly on the display.
 - Printed letters on the display may come off.
- If any foreign substance such as water has entered the appliance, unplug the power plug and contact your nearest service center.
 - Failing to do so may result in an electric shock or fire.
- Use a clean, dry cloth to remove any foreign matter or dust from the power plug blades. Do not use a wet or damp cloth when cleaning the plug.
 - Otherwise, there is a risk of fire or electric shock.
- Do not clean the appliance by spraying water directly onto it.
- Do not use benzene, thinner, or Clorox, Chloride for cleaning.
 - They may damage the surface of the appliance and may cause a fire.
- Before cleaning or performing maintenance, unplug the appliance from the wall socket.
 - Failing to do so may result in an electric shock or fire.

Critical disposal warnings

WARNING

- Please dispose of the packaging material from this product in an environmentally friendly manner.
- Ensure that none of the pipes on the back of the refrigerator are damaged prior to disposal.
- R-600a or R-134a is used as a refrigerant. Check the compressor label on the rear of the appliance or the rating label inside the freezer to see which refrigerant is used for your refrigerator. If this refrigerator contains flammable gas (Refrigerant R-600a), contact your local authority in regard to safe disposal of this product.
- When disposing of this refrigerator, remove the door/door seals and door latch so that small children or animals cannot become trapped inside. Children should be supervised to ensure that they do not play with the appliance. If trapped inside, a child may get hurt or suffocate to death.
 - If trapped inside, the child may become injury and suffocate to death.
- Cyclopentane is used in the insulation. The gases in the insulation material require a special disposal procedure. Please contact your local authorities in regard to the environmentally safe disposal of this product.

-
- Keep all packaging materials well out of the reach of children, as packaging materials can be dangerous to children.
 - If a child places a bag over his or her head, the child could suffocate.

Additional tips for proper usage

- In the event of a power failure, call the local office of your electric company and ask how long the failure is going to last.
 - Most power failures that are corrected in an hour or two will not affect your refrigerator temperatures. However, you should minimize the number of door openings while the power is off.
 - Should the power failure last more than 24 hours, remove and discard all frozen food.
- The refrigerator might not operate consistently (frozen contents can thaw or temperatures can become too warm in the frozen food compartment) if sited for an extended period of time in a location where ambient air temperatures are constantly below the temperatures for which the appliance is designed.
- In case of particular foods, keeping it under refrigeration can have a bad effect on preservation due to its properties.
- Your appliance is frost free, which means there is no need to manually defrost your appliance. This will be carried out automatically.
- Temperature rise during defrosting complies with ISO requirements. If you want to prevent an undue rise in the temperature of frozen food while the appliance defrosts, wrap the frozen food in several layers of newspaper.
- Do not re-freeze frozen foods that have thawed completely.

Safety information

Saving Energy Tips

- Install the appliance in a cool, dry room with adequate ventilation. Ensure that it is not exposed to direct sunlight and never put it near a direct source of heat (a radiator, for example).
- Not to block any vents and grilles is recommended for energy efficiency.
- Allow warm food to cool down before placing it in the appliance.
- Put frozen food in the refrigerator to thaw. You can then use the low temperatures of the frozen products to cool food in the refrigerator.
- Do not keep the door of the refrigerator open for too long when putting food in or taking food out. The shorter the time the door is open, the less frost build-up you'll have in the freezer.
- It is recommended to install the refrigerator with clearance to the back and sides. This will help reduce power consumption and keep your energy bills lower.
- For the most efficient use of energy, please keep the all inner fittings such as baskets, drawers, shelves on the position supplied by manufacturer.

This appliance is intended to be used in household and similar applications such as

- staff kitchen areas in shops, offices and other working environments;
- farm houses and by clients in hotels, motels and other residential type environments;
- bed and breakfast type environments;
- catering and similar non-retail applications.

Instructions about the WEEE



Correct Disposal of This Product (Waste Electrical & Electronic Equipment) (Applicable in countries with separate collection systems)

This marking on the product, accessories or literature indicates that the product and its electronic accessories (e.g. charger, headset, USB cable) should not be disposed of with other household waste at the end of their working life. To prevent possible harm to the environment or human health from uncontrolled waste disposal, please separate these items from other types of waste and recycle them responsibly to promote the sustainable reuse of material resources.

Household users should contact either the retailer where they purchased this product, or their local government office, for details of where and how they can take these items for environmentally safe recycling.

Business users should contact their supplier and check the terms and conditions of the purchase contract. This product and its electronic accessories should not be mixed with other commercial wastes for disposal.

For information on Samsung's environmental commitments and product regulatory obligations, e.g. REACH, WEEE or Batteries, visit our sustainability page available via www.samsung.com

(For products sold in European countries and in the UK only)

Installation

Follow these instructions carefully to ensure a proper installation of this refrigerator and to prevent accidents before using it.

WARNING

- Use the refrigerator only for its intended purpose as described in this manual.
- Any servicing must be performed by a qualified technician.
- Dispose of the product packaging material in compliance with the local regulations.
- To prevent electric shock, unplug the power cord before servicing or replacements.

Refrigerator at a glance

The actual image and provided parts of the refrigerator may differ, depending on the model and the country.

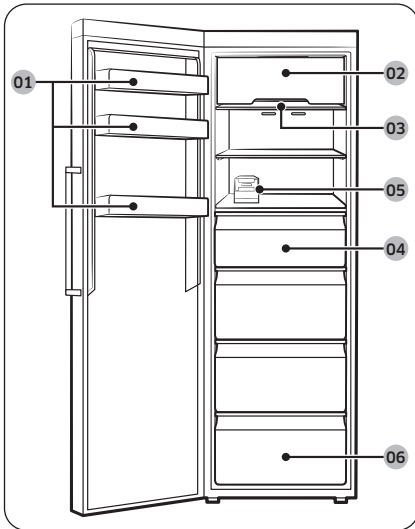

- 01** Door bin
- 02** Top shelf cover *
- 03** Freezer shelf
- 04** Freezer drawer
- 05** Twist ice maker *
- 06** Bottom drawer

* Applicable models only

NOTE

- For best energy efficiency, make sure all of shelves, drawers, and baskets are placed in their original position.

Step-by-step installation

STEP 1 Select a site

Site requirements:

- Solid, level surface without carpeting or flooring that may obstruct ventilation
- Away from direct sunlight
- Adequate room for opening and closing the door
- Away from a heat source
- Room for maintenance and servicing

Clearance

See the following figures and tables for space requirements for installation.

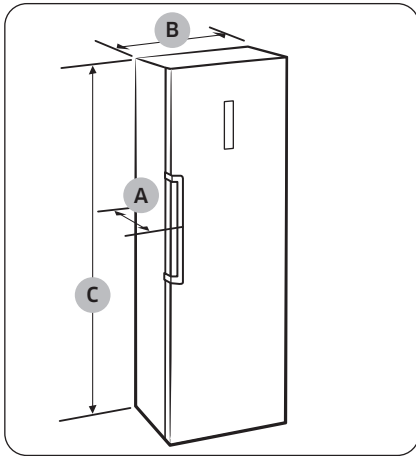

	Bar handle type	Recess handle type
Depth "A"	694 mm	644 mm
Width "B"	595 mm	
Overall Height "C"	1858 mm	

Installation

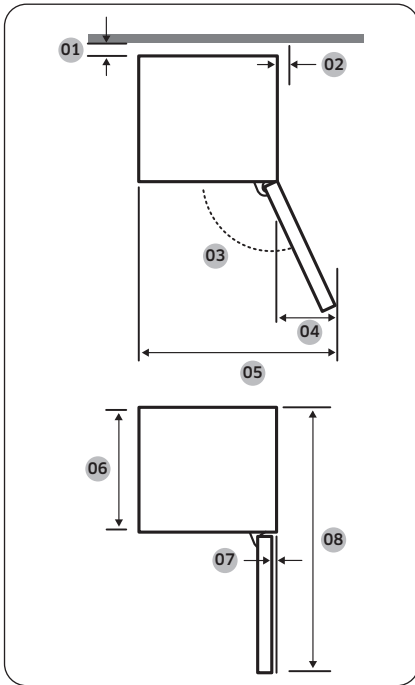

	Bar handle type	Recess handle type
01	more than 50 mm recommended	
02	more than 12 mm recommended	
03	105°	
04	181.5 mm	140.5 mm
05	776.5 mm	730.5 mm
06	575 mm	575 mm
07	5.5 mm	5.5 mm
08	1194 mm	1194 mm

NOTE

The measurements in the table may differ, depending on the measuring method.

STEP 2 Spacing (applicable models only)

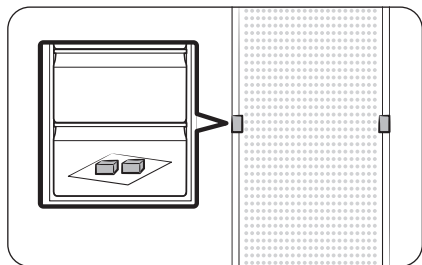

1. Open the door and locate the provided spacers (x2).
2. Unpack both spacers and attach them to the rear of the refrigerator as shown. They help ventilate air to the rear wall and save power consumption.

STEP 3 Flooring

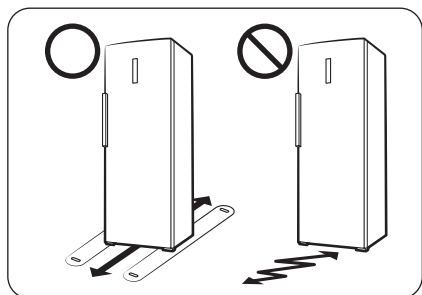

- The surface to install the refrigerator must support a fully loaded refrigerator.
- To protect the floor, put a large piece of cardboard on each foot of the refrigerator.
- Once the refrigerator is in its final position, do not move it unless necessary to protect the floor. If you have to, use a thick paper or cloth such as old carpet along the movement path.

Installation

STEP 4 Adjust the leveling legs

CAUTION

- The refrigerator must be leveled on a flat, solid floor. Failing to do so can cause damage to the refrigerator or physical injury.
- Leveling must be performed with an empty refrigerator. Make sure no food items remain inside the refrigerator.
- For safety reasons, adjust the front side a little higher than the rear side.

The refrigerator can be leveled using the front legs that have a special screw (leveler) for leveling purposes. Use a flat-head screwdriver for leveling.

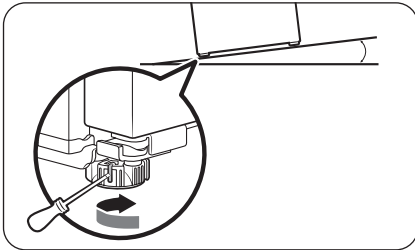

To adjust the height of the left side:

Insert a flat-head screwdriver into the leveler of the front left leg. Turn the leveler clockwise to raise, or turn it counterclockwise to lower.

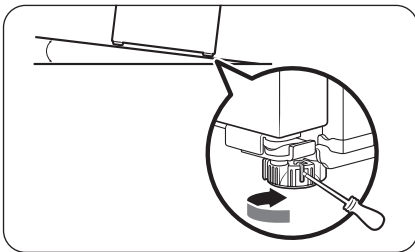

To adjust the height of the right side:

Insert a flat-head screwdriver into the leveler of the front right leg. Turn the leveler clockwise to raise, or turn it counterclockwise to lower.

To adjust the rear height (Auto Open Door option models only)

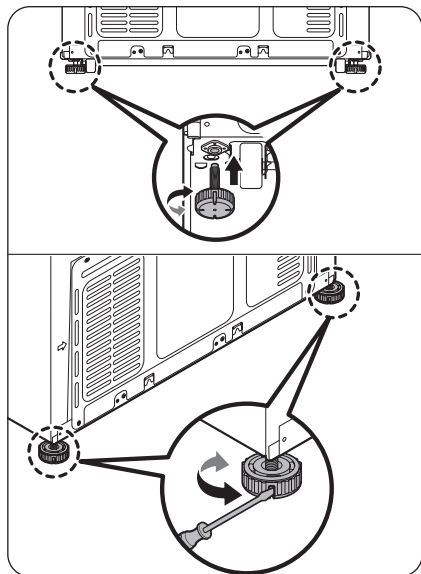

- The provided rear levelling legs allow you to adjust the rear height of the refrigerator when necessary.
- Attach the rear levelling legs to the rear bottom of the refrigerator as shown in the figure.
- After attaching, adjust the rear height in the same way as the front levelling legs.

⚠ CAUTION

When tilting the refrigerator to attach or adjust the rear levelling legs, make sure the refrigerator does not tip over. Failure to do so may cause injury or product damage.

Installation

Adjusting the rear side height (applicable models only)

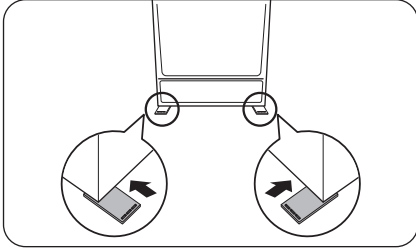

If you need to raise the rear side of the refrigerator to level it, you can use the provided level adjustment pad(s). Follow these instructions to raise the rear side of the refrigerator.

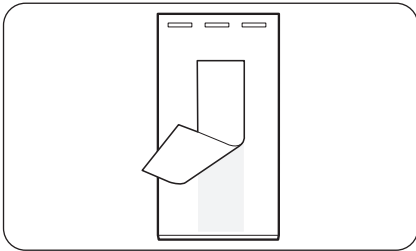

1. Choose the position on the floor where you need to attach the level adjustment pad.
2. Peel the double-sided tape on the bottom of the level adjustment pad.

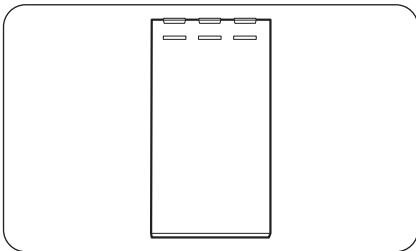

3. Attach the level adjustment pad to the floor.

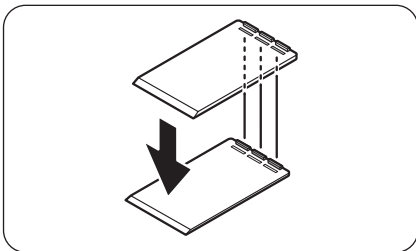

4. If you need to further raise the rear height, attach another adjustment pad on top of the first level adjustment pad.

NOTE

- You may skip this step if you can level the refrigerator using a single attachment pad.
- Make sure the ribs on the first adjustment pad are inserted into the grooves of the second level adjustment pad.

STEP 5 Initial settings

By completing the following steps, the refrigerator should be fully functioning.

1. Remove the PE foam sheet on each shelf corner, which is attached to protect the refrigerator during transportation.
2. Plug the power cord into the wall socket to turn the refrigerator on.
3. Open the door, and check if the interior light lights up.
4. Set the temperature to the lowest, and wait until the refrigerator reaches the set temperature. Now the refrigerator is ready for use.

NOTE

When the refrigerator powers on, the alarm will sound. To turn off the alarm, press Freezer.

STEP 6 Final check

When installation is complete, confirm that:

- The refrigerator is plugged into an electrical outlet and grounded properly.
- The refrigerator is installed on a flat, level surface with a reasonable clearance from the wall or the cabinet.
- The refrigerator is level and is sitting firmly on the floor.
- The door opens and closes freely, and the interior light turns on automatically when you open the door.

Operations

Main panel

The actual appearance of your main panel may differ from the figure and the main panel design is subject to change without notice.

Type A

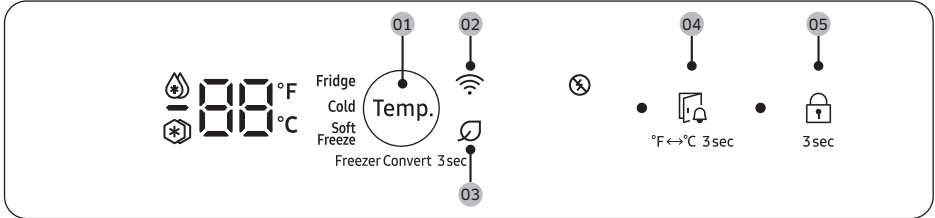

01 Temp. / Freezer Convert 3 sec

02 Network connection *

03 AI Energy Mode *

04 Door alarm

05 Lock

* Applicable models only

01 Temp. / Freezer Convert 3 sec

Temp.	<p>Tap Temp. to select the desired temperature or available function.</p> <ul style="list-style-type: none"> The selection changes in the following cycle in the Freezer mode: -19 °C → -20 °C → -21 °C → -22 °C → -23 °C → ❄️ (Power Freeze) → -15 °C → -16 °C → -17 °C → -18 °C → -19 °C The selection changes in the following cycle in the Fridge mode: 3 °C → 2 °C → 1 °C → 7 °C → 6 °C → 5 °C → 4 °C → 3 °C
Freezer Convert 3 sec	<p>Touch and hold Temp. for 3 seconds to select the desired operating mode.</p> <ul style="list-style-type: none"> The operating mode changes in the following cycle: Freezer → Soft Freeze → Cold → Fridge → Freezer. When the operating mode is Freezer, all the mode indicators (Fridge, Cold, and Soft Freeze) turn off. Fridge, Cold, or Soft Freeze indicator turns on when the corresponding mode is selected. <p>⚠️ CAUTION</p> <p>Before changing the operating mode, check that the food and containers stored inside are suitable for the selected mode to prevent damage or spoilage.</p>

<p>Power Freeze (applicable models only)</p>	<p>Power Freeze speeds up the freezing process at maximum fan speed. The freezer keeps running at full speed for 50 hours and then returns to the previous temperature.</p> <ul style="list-style-type: none"> • To activate Power Freeze, press and hold Temp. for 3 seconds. The LED indicator on the left side of the button lights up, and the refrigerator will speed up the freezing process. • To deactivate, press and hold Temp. for 3 seconds again. The freezer returns to the previous temperature setting. • To freeze large amounts of food, activate Power Freeze for at least 20 hours before putting food in the freezer. <p>NOTE</p> <ul style="list-style-type: none"> • Using Power Freeze increases power consumption. Make sure you turn it off and return to the previous temperature if you do not intend to use it. • To quickly freeze large quantities of food, remove the drawers and use the provided shelf. • Power Freeze can only be activated when the refrigerator is in the Freezer mode.
---	---

WARNING

- Do not put glass bottles containing liquid in the freezer. When cancelling Fridge mode, the glass bottles may break or burst in the freezer.
- Make sure to remove frozen food from the freezer before enabling the Fridge mode. Frozen foods melt and spoil as the temperature increases (Freezer mode changes to Fridge mode).
- Make sure to remove chilled foods from the freezer before disabling the Freezer mode. Chilled foods may freeze as the temperature decreases (Fridge mode changes to Freezer mode).

NOTE

If you want to use Fridge mode, it is strongly recommended to use plastic containers to store food, especially vegetables.

02 Network connection (applicable models only)

You can control and monitor your refrigerator on the SmartThings app. For more information, see the **SmartThings (applicable models only)** section.

NOTE



If the refrigerator is not connected to the SmartThings app, the Wi-Fi (📶) icon blinks to alert you when opening the door. If you see the blinking Wi-Fi (📶) icon, we recommend that you connect your refrigerator to the SmartThings app.

Operations

03 AI Energy Mode (applicable models only)

The  icon appears if you turn on the AI Energy Mode in the SmartThings app. (applicable models only)

04 Door Alarm / °F ↔ °C 3 sec

Door Alarm	Tap the  button to turn the door alarm on or off. <ul style="list-style-type: none">If the door is left open for more than 2 minutes, the alarm will sound, and the LED indicator on the left side of the button will blink.
°F ↔ °C 3 sec	Touch and hold the  button for 3 seconds to switch the temperature unit between Celsius and Fahrenheit.

05 Lock (3 sec)

Touch and hold the  button for 3 seconds to turn the Lock function on or off.

- When you turn on the function, all controls will be disabled, and the LED indicator on the left side of the button will turn on.
- After you turn on the function, you must turn it off to use the main panel again.

Turning on or off the Wi-Fi (applicable models only)

To turn the Wi-Fi on or off, touch and hold **Temp.** for 10 seconds. The display shows the status of Wi-Fi for 5 seconds (as shown in the figure).

Wi-Fi On

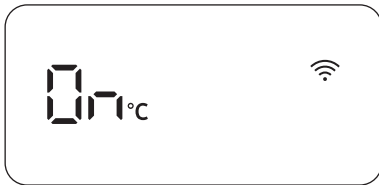

Wi-Fi Off

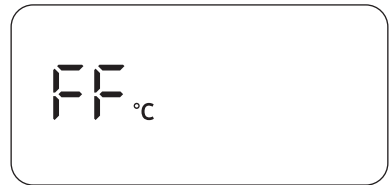

NOTE

- You must turn on the Wi-Fi to connect the refrigerator to the SmartThings app.
- For more information, see the **SmartThings (applicable models only)** section.

Type B

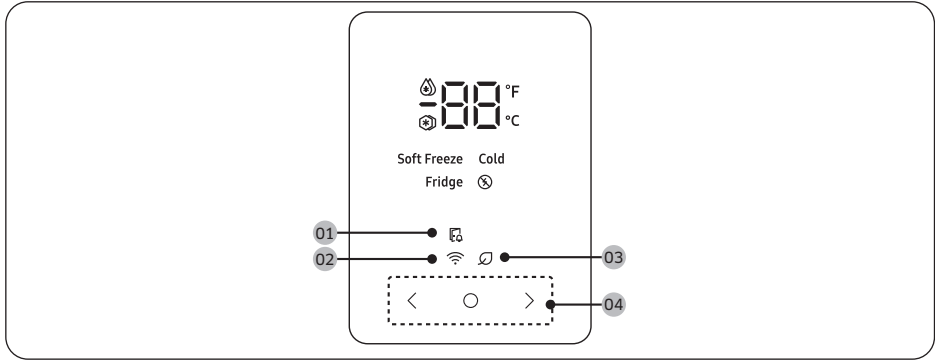

01 Door open indicator

02 Network connection *

03 AI Energy Mode *

04 Buttons

* Applicable models only

01 Door open indicator

This indicator blinks with an alarm if the door is left open for more than 2 minutes.



02 Network connection indicator (applicable models only)

- This icon indicates that the refrigerator is connected to a network.
- You can control and monitor your refrigerator on the SmartThings app. For more information, see the **SmartThings (applicable models only)** section.

03 AI Energy Mode (applicable models only)

The  icon appears if you turn on the AI Energy Mode in the SmartThings app. (applicable models only)

04 Buttons

- When the display is off, tap any button to wake up the display.
- Tap  to select the desired item on the main panel and to confirm any setting changes.
- Tap  or  to change the settings of the selected item on the main panel.

Operations

Setting the desired temperature or function

Select the fridge or freezer and set the desired temperature or function of your choice.

1. Tap any button (< , ○ , or >) to wake up the display.
 - This step may not apply to some models.
2. Tap ○ until the temperature indicator blinks.
3. Tap < or > to select the desired temperature or function.
 - Available selection:  (Power Freeze) ↔ -23 °C ↔ -22 °C ↔ -21 °C ↔ -20 °C ↔ -19 °C ↔ -18 °C ↔ -17 °C ↔ -16 °C ↔ -15 °C ↔ -5 °C (Soft Freeze) ↔ -1 °C (Cold) ↔ 1 °C (Fridge) ↔ 2 °C (Fridge) ↔ 3 °C (Fridge) ↔ 4 °C (Fridge) ↔ 5 °C (Fridge) ↔ 6 °C (Fridge) ↔ 7 °C (Fridge)
4. Wait for 5 seconds or tap ○ to confirm your selection.
 - The temperature indicator stops blinking.

Changing the temperature scale

You can switch the temperature scale between Fahrenheit and Celsius.

1. Tap any button (< , ○ , or >) to wake up the display.
 - This step may not apply to some models.
2. Tap until the °F and °C symbols blink.
3. Tap < or > to select the desired temperature scale.
 - Tap < to select Fahrenheit.
 - Tap > to select Celsius.
4. Wait for 5 seconds or tap ○ to confirm your selection.
 - The °F and °C symbols stop blinking.

Turning on or off the Wi-Fi (applicable models only)

To turn the Wi-Fi on or off, touch and hold > for 10 seconds. The display shows the status of Wi-Fi for 5 seconds (as shown in the figure).

Wi-Fi On



Wi-Fi Off

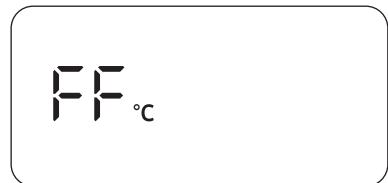

NOTE

- You must turn on the Wi-Fi to connect the refrigerator to the SmartThings app.
- For more information, see the **SmartThings (applicable models only)** section.

SmartThings (applicable models only)

Installation

Visit the Google Play Store, Galaxy Apps, or Apple App Store and search for “SmartThings”. Download and install the SmartThings app provided by Samsung Electronics to your smart device.

NOTE

- The supporting software version of the SmartThings app is subject to change according to the OS supporting policy the manufacturer provides. In addition, as for the SmartThings app or the functions that the app supports, the new application update policy on the existing OS version can be suspended due to usability or security reasons.
- The SmartThings app is subject to change without notice to improve usability or performance. As the mobile phone OS version is updated every year, the SmartThings is also updated continually according to the latest OS. If you have enquiries regarding the items mentioned above, please contact us on st.service@samsung.com
- Recommended encryption systems include WPA/TKIP and WPA2/AES. Any newer or non-standard Wi-Fi authentication protocols are not supported.
- Wireless networks may be affected by the surrounding wireless communication environment.
- If your Internet service provider has registered the MAC address of your PC or modem for identification, your Samsung Smart Refrigerator may fail to connect to the Internet. If this happens, contact your Internet service provider for technical assistance.
- The firewall settings of your network system may prevent your Samsung Smart Refrigerator from accessing the Internet. Contact your Internet service provider for technical assistance. If this symptom continues, contact a local Samsung service center or retailer.
- To configure the wireless access point (AP) settings, see the user manual of the AP (router).
- Samsung Smart Refrigerators support both Wi-Fi 2.4 GHz with IEEE 802.11 b/g/n and Soft-AP protocols. (IEEE 802.11 n is recommended.)
- Unauthorized Wi-Fi wireless routers may fail to connect to applicable Samsung Smart Refrigerators.

Operations

Samsung account

You are required to register your Samsung account to use the app. If you don't have a Samsung account, follow the app's onscreen instructions to create a free Samsung account.

Getting started

Turn on the device you want to connect, open the SmartThings app on your phone, and then follow the instructions below.

If a pop-up appears saying that a new device has been found, tap **ADD NOW**.

If a pop-up doesn't appear, tap the **+** button, and then select the device you want to connect from the list of available devices.

If your device isn't in the list of available devices, tap **Supported Devices**, select the device type (Refrigerator), and then select the specific device model.

Follow the instructions in the app to set up your device. Once setup is complete, your refrigerator will appear as a "card" on your **Devices** screen.

Refrigerator app

Integrated control



You can monitor and control your refrigerator at home and on the go.

- Tap the refrigerator icon on the SmartThings Dashboard or tap the Devices icon at the bottom of the Dashboard, and then tap the refrigerator "card" to open the Refrigerator page.
- Check the operation status or notifications related to your refrigerator, and then change options or settings if necessary.

NOTE

Some options or settings of the refrigerator may not be available for remote control.

Category	Item	Description
Monitoring	Freezer temperature	Displays the current temperature setting of the freezer.
	Energy monitoring	Checks the accumulated power consumption of the freezer for the last 180 days.
Functions	Power Freeze	You can turn Power Freeze on or off, and check the current settings.
Alarms	Abnormally high temperature	This alarm is triggered when the freezer has abnormally high temperatures.
	Door opening	This alarm is triggered if the freezer door is open for a specific time.

Category	Item	Description
AI Energy Mode *		<p>You can turn on or off the AI Energy Mode under the Energy menu in the SmartThings app.</p> <p>You can check the status of the AI Energy Mode on the SmartThings app. On some models, the  icon appears on the main panel to indicate that AI Energy Mode is operating. (applicable models only)</p> <p>Turning on the AI Energy Mode decreases energy consumption, but it may also reduce the cooling performance.</p> <p> NOTE</p> <p>The AI Energy Mode may not operate according to user settings or the operating environment.</p>

* applicable models only

Security updates information

Security updates are provided to strengthen the security of your device and protect your personal information. For more information on security updates, visit <https://security.samsungda.com>.

* The website supports only some languages.

Operations

Auto Open Door function (applicable models only)

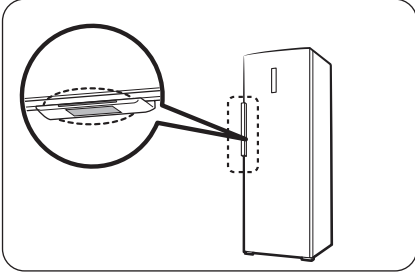

Touch the sensor near the door handle. The door will open.

NOTE

- The door does not close automatically. Close the door manually after use.
- The opening angle (degree) of the door may vary depending on the installation environment, such as the floor where the refrigerator is installed, the level of the refrigerator, and the load of food stored in the door bin.
 - If the door opens too wide or not wide enough, check and make sure the refrigerator is level. (For more information, see the “**STEP 4 Adjust the leveling legs**” section on page 20.)

CAUTION

- The Auto Open Door function may malfunction if you open and close the door repeatedly.
- Do not push or forcibly stop the door while it is opening automatically. Doing so may cause the product to malfunction.
 - Be careful not to get hit by the door when it opens automatically.
- If the door does not open easily after being opened repeatedly, wait about 1 minute and then try again. This may occur because of the air pressure changes inside the refrigerator after the door is opened and closed.
- If you accidentally touch the sensor, the door may open. Make sure the door is closed.

Special features

The actual image and special functions of your refrigerator may differ depending on the model and the country.

Ice making (applicable models only)

Twist ice maker (applicable models only)

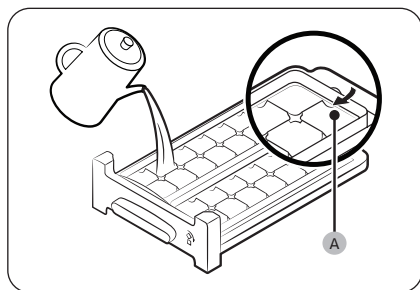

1. Open the freezer door, and slide open the ice tray.
2. Fill the tray with water up to the **maximum level (A)** marked on the inner rear of the tray.
3. Slide the tray back into position.

 **NOTE**

The ice making time depends on your temperature settings.

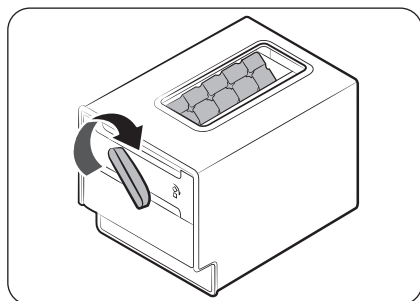

 **NOTE**

- Make sure the ice cube storage bin is in place under the ice tray.
- To dispense the ice cubes, turn the ice tray handle to the right to empty the ice cubes into the bin.
- To take out the bin, pull it forward.
- Put the twist ice maker on the freezer shelf if it does not fit under the shelf.

Operations

Tray type (applicable models only)

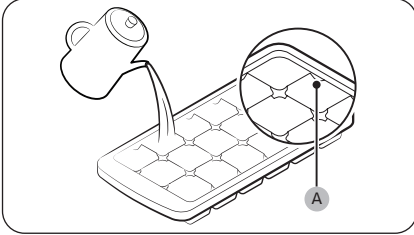

To make ice cubes, fill the tray with water up to the **maximum level (A)** marked on the inner rear of the tray.

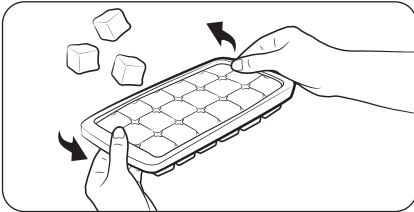

To empty the ice tray, hold both ends of the tray and gently twist to remove the ice cubes.

To secure more storage space (applicable models only)

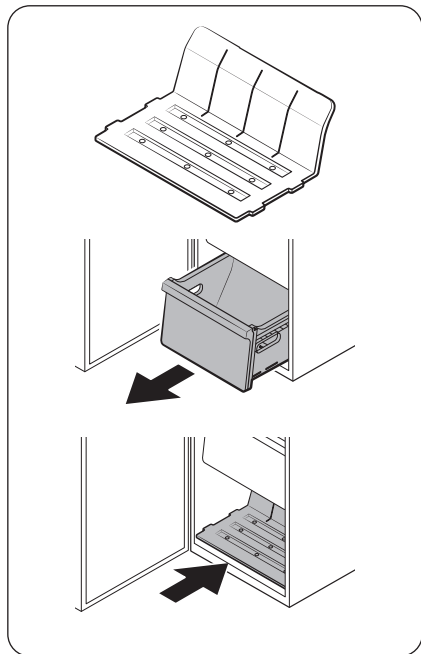

If you need more storage space, remove the top shelf cover and all 4 drawers and insert the provided shelf (see the figure) in the inner bottom of the main unit. Then, remove the Slim Ice Maker.

NOTE

- Removal of the top shelf cover and the drawers does not affect thermal and mechanical characteristics of the freezer.
- A declared storage volume of the freezer is based on the conditions where the top shelf cover and all the drawers are removed and the provided shelf is inserted.

Maintenance

Door reversal

WARNING

- The warranty does not cover reversal failure or property damage occurring due to unapproved agencies.
- Make sure that the refrigerator is disconnected from the power source before reversing the door.
- You must wait for at least an hour after door reversal is complete. This is to prevent any electric shock that could occur.
- Reversing the door must be performed by Samsung-approved servicing personnel at your own expense because this kind of servicing is not covered by the Warranty.

CAUTION

The door is heavy. Have at least two people work on the door reversal. Otherwise, it may cause a personal injury.

Tools required (not provided)



Phillips screwdriver



Flat-head screwdriver



Adjustable wrench

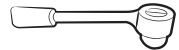

8 mm socket wrench
(for bolts)

Accessories

The accessories below may differ in appearance depending on the model.



Top-left door hinge cover



Top-left door hinge



Cam riser



Low cam riser



Cap space

CAUTION

Throughout the entire reversal procedure, keep all the small parts (screws, caps, etc.) of the refrigerator away from children or infants for safety reasons.

Step-by-step instructions

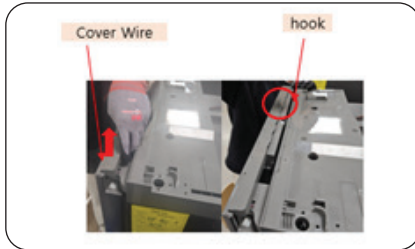

1. Use the flat-head screwdriver to unlock the hook of the wire cover (located on the top of the door) before pulling up to remove.

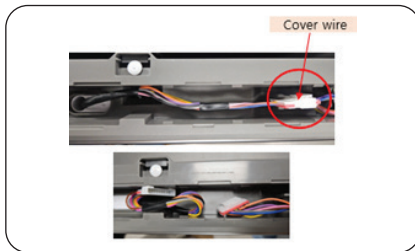

2. Remove and disconnect the wire connector from inside the door cap, which is located on the top of the door. (applicable models only)

CAUTION

Keep the wire cover in a safe place for later use.



3. Use the Phillips screwdriver to loosen the left/right screws (x2) from the PBA cover, which is on the top of the refrigerator. Pull up the rear of the PBA cover first to remove.

Maintenance

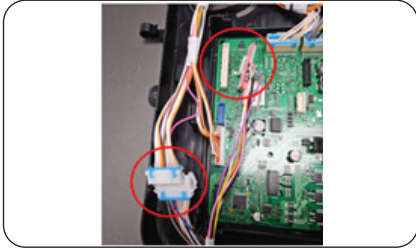

4. Remove the top cable wires from inside the PBA box.



5. Use the Phillips screwdriver to loosen the screws (x4) from the top table. Pull up gently to release the hook of the hinge cover before removing the top table from the refrigerator.

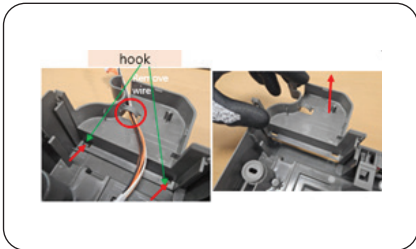

6. Remove the wires over the hinge cover of the top table. Then, press to release the hooks (x2) simultaneously and pull up the hinge cover.

CAUTION

Keep the hinge cover in a safe place for reversing the door later.

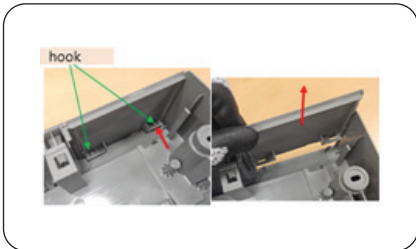

7. From the opposite side, press to release the hooks (x2) simultaneously and pull up the hinge cap.

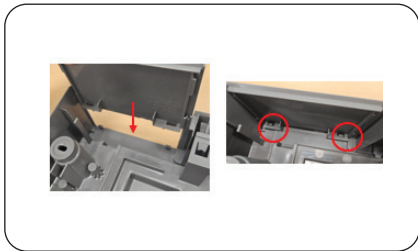

8. Insert the hinge cap (Step 7) in the position of the hinge cover (Step 6) until the hook is properly locked.

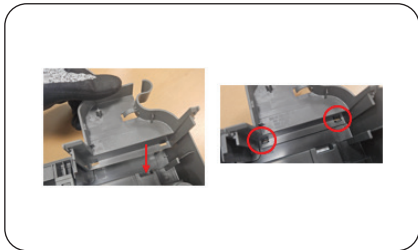

9. Press to fit the hinge cover of the top-right door in the position of the hinge cap (Step 7).

NOTE

Use the hinge cover of the top-right door included in the door reversing kit.

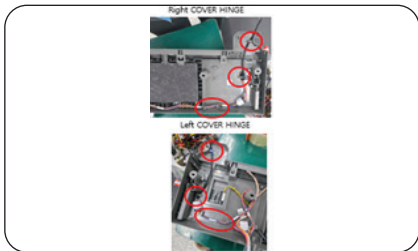

10. Reinsert the wires (Step 6) and insert the wire tape in the protruding area of the hinge cover.

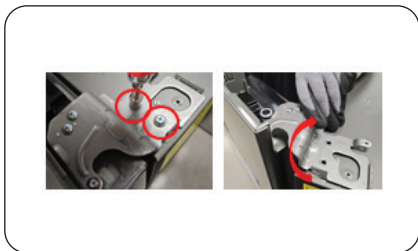

11. Use the 8 mm wrench to loosen the screws (x2) from the top hinge. Lift the top hinge gently so that the shaft is detached from the door cap.

CAUTION

- Take caution not to drop the door. Otherwise, the door can cause a physical injury due to its weight.
- Keep the top hinge in a safe place for reversing the door later.

Maintenance



12. Lift the door so that it is detached from the shaft of the low hinge.

CAUTION

Take caution not to drop the door. Otherwise, the door can cause a physical injury due to its weight.



13. Lay down the door on the floor.

NOTE

Put a carton box on the floor to prevent damage to the door.



14. Use the Phillips screwdriver to loosen the screws at the bottom of the door. Then, remove the cam riser and the stopper.

CAUTION

Keep the cam riser in a safe place for reversing the door later.



15. Apply grease (not provided) to the cam riser (Accessories) in the arrow-marked areas as shown. Then, insert the stopper and the cam riser in this sequence in the opposite of the door bottom. Use the Phillips screwdriver to fasten them.

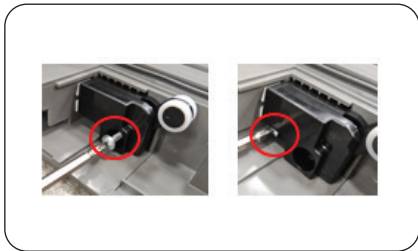

16. Use the Phillips screwdriver to loosen the auto close screws (x2) at the top of the door.

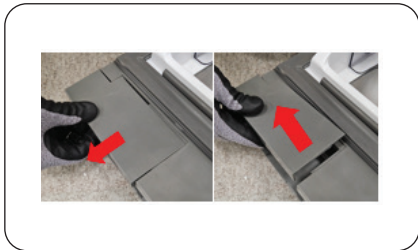

17. Pull upward then outward the cap space at the top of the door (the opposite side of the auto close) to remove.

CAUTION

Keep the cap space in a safe place for reversing the door later.

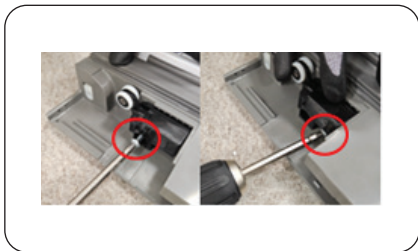

18. Insert the auto close (Step 16) in the cap space position. Then, use the Phillips screwdriver to tighten the screws (x2).

NOTE

You can use the auto close in the reverse direction as well.

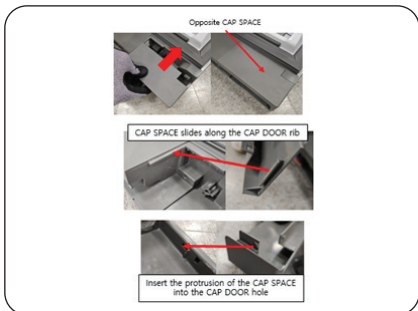

19. Slide in the provided cap space along the door cap rib (Accessories), (where the auto close was removed) until the protruding part of the cap space inserts into the door cap hole.

Maintenance

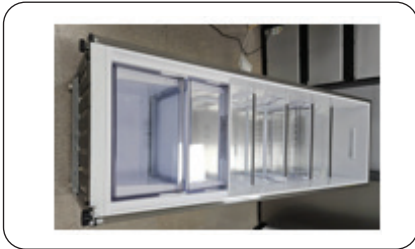

20. Lay down the refrigerator on the floor.

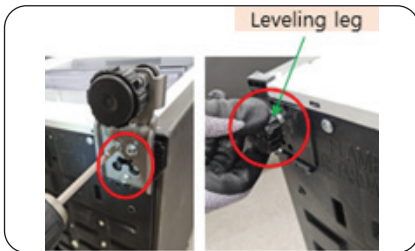

21. Use the Phillips screwdriver to loosen the screws (x3) of the low hinge at the bottom of the refrigerator. Turn to remove the leveling leg, which is in the opposite side of the low hinge.

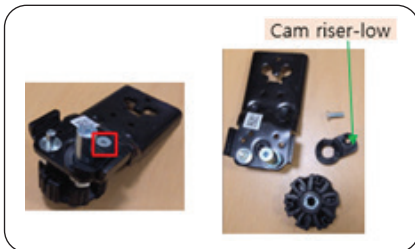

22. Use the Phillips screwdriver to loosen the screws of the low cam riser. Then, remove the leveling leg from the low hinge.

CAUTION

Keep the low cam riser in a safe place for reversing the door later.

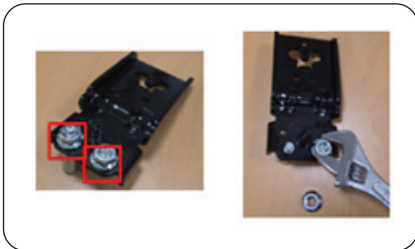

23. Use the 12 mm socket wrench to loosen the shaft nuts (x2) on the low hinge.

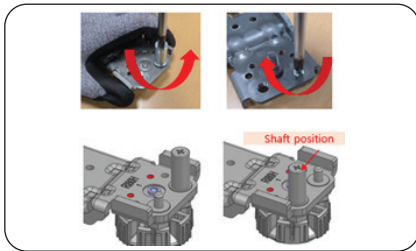

24. Use the Phillips screwdriver to remove the two shafts from the low hinge and switch their positions before tightening again. Reinsert the shaft nuts (x2) and the leveling leg as well.

⚠ CAUTION

Make sure to switch the position of each shaft before reinserting.



25. Apply grease (not provided) to the arrow-marked areas of the low cam riser as shown. Insert the low cam riser in the shaft position before tightening with the screw.

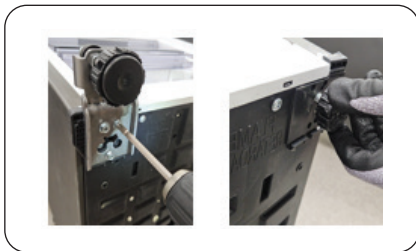

26. Use the Phillips screwdriver to tighten the low hinge with the screws (x3) in the opposite side of the refrigerator's bottom.

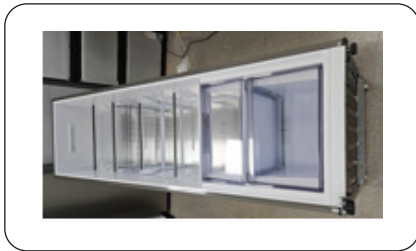

27. Set the refrigerator upright.

Maintenance



28. Reinsert the door so that it fits into the shaft of the low hinge.

CAUTION

Take caution not to drop the door. Otherwise, the door can cause a physical damage due to its weight.

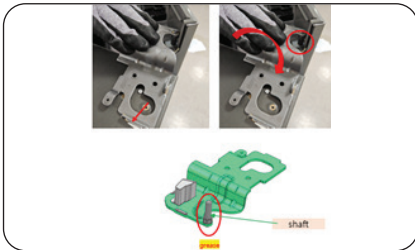

29. Apply grease (not provided) to the rear shaft of the provided top-left door hinge. Hook the shaft to the rear locking position before turning it slowly until it inserts into the door hole.

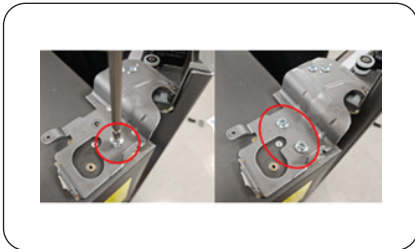

30. Use the Phillips screwdriver or the 8 mm socket wrench to tighten the top hinge using the screws (x2).



31. Hook the hinge cover to the hinge before tightening it on the top table using the screws (x4).



- 32.Reconnect the wire connectors inside the door cap before arranging the wires inside the door cap. (applicable models only)

⚠ CAUTION

Make sure the wires are not exposed outside.

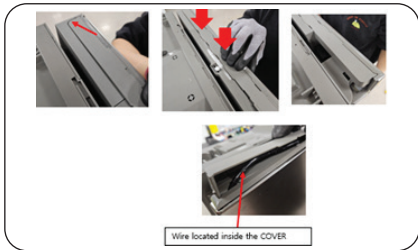

- 33.Insert the wire cover with the opposite side of the hinge first.

📖 NOTE

Make sure the wires are not exposed outside. Otherwise, try again.

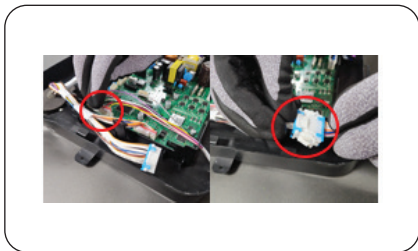

- 34.Connect the wires inside the PBA box (located on the top of the refrigerator) to the PBA.



- 35.Hook the front side of the PBA cover to the PBA box. Then, press down to fix the PBA cover.

Maintenance

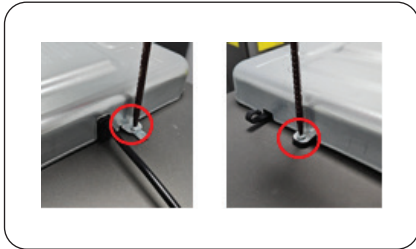

36. Use the Phillips screwdriver to fasten the PBA cover using the screws (x2).

Auto Open Door option touch sensor reversible (applicable models only)



1. Put the protective tape on the rear of the Auto Open Door sensor (located on the recess handle of the door). Then, insert the flat-head screwdriver (3-6 mm head) in the hook of the Auto Open Door sensor to remove.

CAUTION

To prevent scratches on the Auto Open Door sensor, make sure to put the protective tape on the sensor.

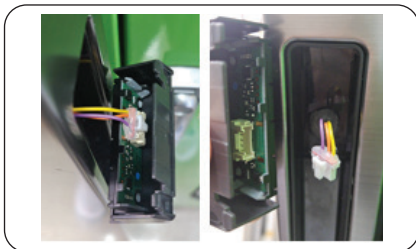

2. Disconnect the wire connector of the touch sensor.



3. Insert the flat-head screwdriver in the handle cover (located in the opposite of the touch sensor) to remove.
4. Switch the positions of the touch sensor and the handle cover before reinserting them.

Reversing the door handle position (applicable models only)



1. Remove the handle covers.



2. Use a Phillips screwdriver to remove the screws and detach the handle.

Maintenance

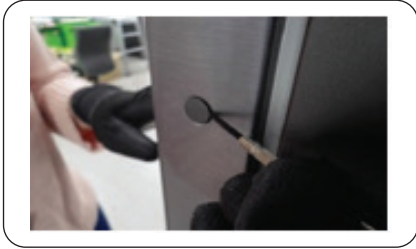

3. Use a flat-head screwdriver to remove the hole caps from the opposite side of the door.

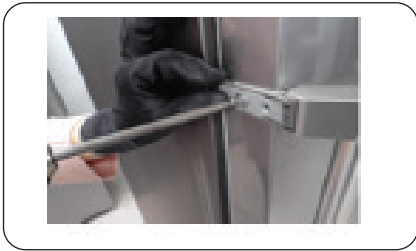

4. Insert the hole caps into the holes from which you detached the handle.
5. Place the handle on the opposite side of the door, aligning the holes on the handle and the door.
6. Use a Phillips screwdriver to attach the handle with the screws.



7. Attach the handle covers.

Handle and care

Shelves

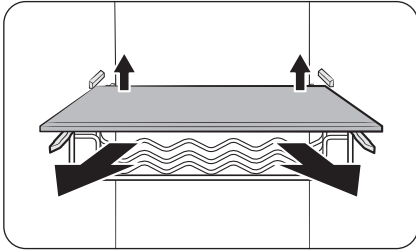

Slightly lift up the rear side of the shelf to pull out.

Door bins

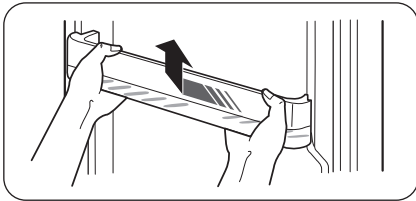

Slightly lift up and pull out the door bin.

CAUTION

To prevent accidents, empty the door bins before removing.

Top shelf cover (applicable models only)

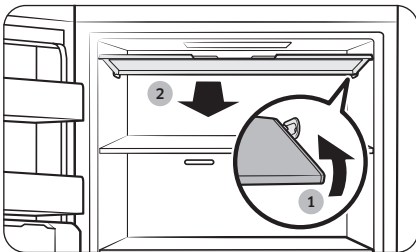

1. Push the right side of the cover inwards to unhook the cover.
2. Then, pull up the cover to the front to remove.

Maintenance

Cleaning

Interior and exterior

WARNING

- Do not use benzene, thinner, vinegar, liquid bleach, baking soda, citric, salt mixtures or home/car detergent such as Clorox™ for cleaning purposes. They may damage the surface of the refrigerator and cause a fire.
- Do not spray water onto the refrigerator. This may cause an electric shock.

Regularly use a dry cloth to remove all foreign substances such as dust or water from the power plug terminals and contact points.

1. Unplug the power cord.
2. Use a moistened, soft, lint-free cloth or paper towel to clean the refrigerator's interior and exterior.
3. When done, use a dry cloth or paper towel to dry well.
4. Plug in the power cord.

Replacement

LED Lamps

To replace the lamps of the refrigerator, contact a local Samsung service center.

WARNING

- The lamps are not user-serviceable. Do not attempt to replace a lamp yourself. This can cause an electric shock.

Lamp (Light Source)

This product contains a light source of energy efficiency class <G>.

The lamp(s) and/or control gear(s) are not user-serviceable. To replace the lamp(s) and/or control gear(s) in the product, contact a local Samsung service centre.

For detailed instructions on replacing lamp(s) or control gear(s) in your product, visit the Samsung website (<http://www.samsung.com>), go to Support > Support home, and then enter the model name.

For detailed instructions on dismantling lamp(s) and/or control gear(s), simply follow the replacement instruction reached as described above.

Door panel

You can select the door panel you prefer for your BESPOKE refrigerator. Purchase the door panel at a Samsung retail store or Samsung website (www.samsung.com), and an authorized installer will install the panel for you. (Available place to purchase the door panel may vary depending on the country.)

CAUTION

- Disassembling or assembling the door panel on your own may result in product damage or personal injury. If you find any problems with the door panel, contact a Samsung service center.
- A service fee may be charged for panel replacement even within the warranty period.

Pair installation

Use the installation accessories provided with the fridge (RR models) for pair or kitchen fit installation. The installation accessories are not in the freezer (RZ models).

Troubleshooting

Before calling for service, review the checkpoints below. Any service calls regarding normal situations (No Defect Cases) will be charged to users.

General

Temperature

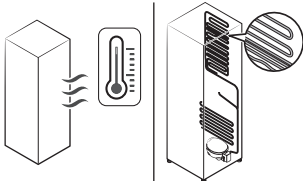
Symptom	Possible causes	Solution
The freezer does not operate. The freezer temperature is warm.	<ul style="list-style-type: none"> The power cord is not plugged in properly. 	<ul style="list-style-type: none"> Properly plug in the power cord.
	<ul style="list-style-type: none"> Temperature control is not set correctly. 	<ul style="list-style-type: none"> Set the temperature lower.
	<ul style="list-style-type: none"> The refrigerator is located near a heat source or direct sunlight. 	<ul style="list-style-type: none"> Keep the refrigerator away from direct sunlight or a heat source.
	<ul style="list-style-type: none"> Not enough clearance between refrigerator and sides/rear. 	<ul style="list-style-type: none"> We recommend that the gap between the refrigerator and nearby walls (or cabinets) is more than 50 mm.
	<ul style="list-style-type: none"> The refrigerator is overloaded. Food is blocking the refrigerator vents. 	<ul style="list-style-type: none"> Do not overload the refrigerator. Do not allow food to block ventilation.
The freezer is over-cooling.	<ul style="list-style-type: none"> Temperature control is not set correctly. 	<ul style="list-style-type: none"> Set the temperature higher.
The interior wall is hot.	<ul style="list-style-type: none"> The refrigerator has heat-proof piping in the interior wall. 	<ul style="list-style-type: none"> To prevent condensation from forming, the refrigerator has heat-proof piping in the front corners. If the ambient temperature rises, this equipment may not work effectively. This is not a system failure. 

Odors

Symptom	Possible causes	Solution
The refrigerator has odors.	<ul style="list-style-type: none"> Spoiled food. 	<ul style="list-style-type: none"> Clean the refrigerator and remove any spoiled food.
	<ul style="list-style-type: none"> Food with strong odors. 	<ul style="list-style-type: none"> Make sure strong smelling food is wrapped airtight.

Condensation

Symptom	Possible causes	Solution
Condensation forms on the interior walls.	<ul style="list-style-type: none"> If the door is left open, moisture enters the refrigerator. 	<ul style="list-style-type: none"> Remove the moisture and do not open the door for a long time.
	<ul style="list-style-type: none"> Food with high moisture content. 	<ul style="list-style-type: none"> Make sure food is wrapped airtight.

Auto Open Door (applicable models only)

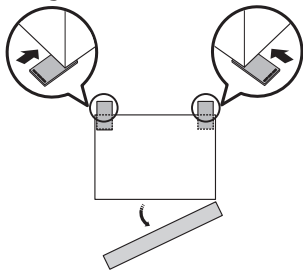
Symptom	Possible causes	Solution
<p>The door does not open wide enough.</p> 	<p>The rear sides of the refrigerator are low.</p>	<p>Raise the rear sides of the refrigerator to level it.</p> 

Troubleshooting

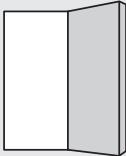
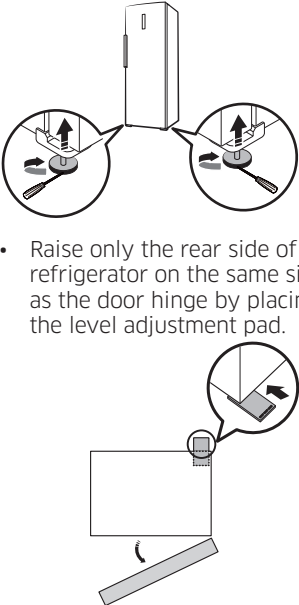
Symptom	Possible causes	Solution
<p data-bbox="116 568 376 592">The door opens too wide.</p>  <p>The diagram shows a side view of a refrigerator door that is swung open to a wide angle, indicating it is not properly aligned or balanced.</p>	<p data-bbox="423 644 645 692">The front sides of the refrigerator are low.</p>	<ul data-bbox="684 288 1025 440" style="list-style-type: none">• Raise the front sides of the refrigerator to level it. (For more information on levelling the refrigerator, see the “STEP 4 Adjust the leveling legs” section on page 20.)• Raise only the rear side of the refrigerator on the same side as the door hinge by placing the level adjustment pad.  <p>The diagrams illustrate the leveling process. The top diagram shows a refrigerator with two circular callouts, each showing a hand adjusting a leveling leg with a screwdriver, with an upward arrow indicating the direction of adjustment. The bottom diagram shows a side view of the refrigerator with a level adjustment pad being placed under the rear leg on the same side as the door hinge, with a callout showing the pad being pushed into place.</p>

Do you hear abnormal sounds from the refrigerator?

Before calling for service, review the checkpoints below. Any service calls related to normal sounds will be charged to the user.

These sounds are normal.

- When starting or ending an operation, the refrigerator may make sounds similar to a car engine igniting. As the operation stabilizes, the sounds will decrease.

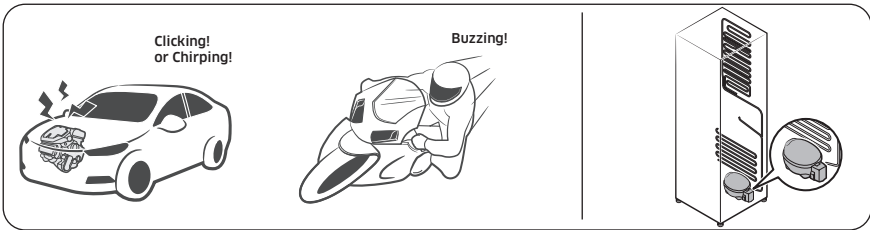

- While the fan is operating, these sounds may occur. When the refrigerator reaches the set temperature, no fan sound will occur.

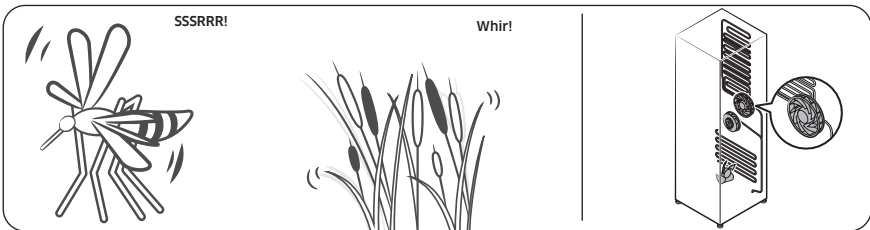

- During a defrost cycle, water may drip on the defrost heater, causing sizzling sounds.

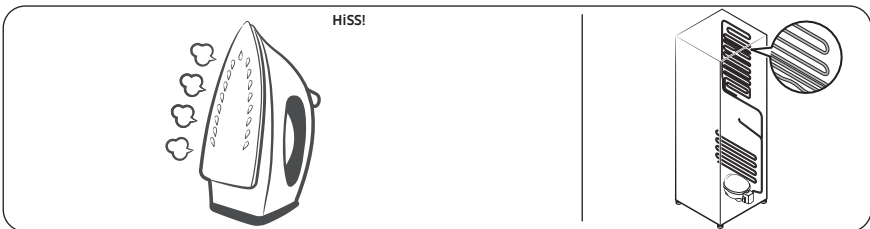

Troubleshooting

- As the refrigerator cools or freezes, refrigerant gas moves through sealed pipes, causing bubbling sounds.

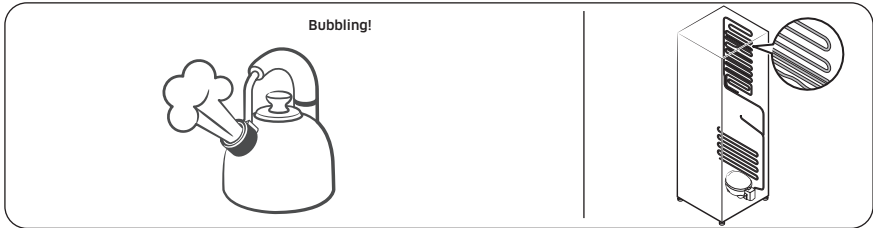

- As the refrigerator temperature increases or decreases, plastic parts contract and expand, creating knocking noises. These noises occur during the defrosting cycle or when electronic parts are working.

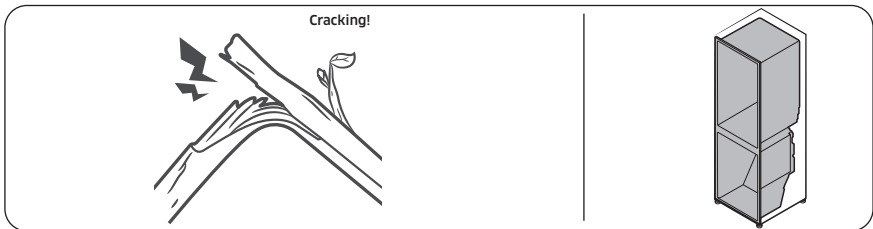

- For ice maker models: When the water valve opens to fill the ice maker, buzzing sounds may occur.
- Because of pressure equalizing when opening and closing the refrigerator door, whooshing sounds may occur.

SmartThings (applicable models only)

Symptom	Action
Could not find "SmartThings" in the app market.	<ul style="list-style-type: none">The supporting software version of the SmartThings app is subject to change according to the OS supporting policy the manufacturer provides. In addition, as for the SmartThings app or the functions that the app supports, the new application update policy on the existing OS version can be suspended due to usability or security reasons.
The SmartThings app fails to operate.	<ul style="list-style-type: none">The SmartThings app is available for applicable models only.The old Samsung Smart Refrigerator app cannot connect with Samsung Smart Home models.
The SmartThings app is installed but is not connected to my refrigerator.	<ul style="list-style-type: none">You must log into your Samsung account to use the app.Make sure that your router is operating normally.If the Wi-Fi icon on the refrigerator's display is off, this indicates that no network connection has been established yet. In this case, use the SmartThings app to connect and register your refrigerator to the access point (AP) of your house.
Could not log into the app.	<ul style="list-style-type: none">You must log into your Samsung account to use the app.If you don't have a Samsung account, follow the app's onscreen instructions to create one.
An error message appears when I try to register my refrigerator.	<ul style="list-style-type: none">Easy Connection may fail due to the distance from your access point (AP) or electrical interference from the surrounding environment. Wait a moment and try again.
The SmartThings app is successfully connected to my refrigerator but does not run.	<ul style="list-style-type: none">Exit and restart the SmartThings app, or disconnect and reconnect the router.Power off the refrigerator, and then power it on again after 1 minute.

Appendix

Safety Instruction

- For the most efficient use of energy, please keep the all inner fittings such as baskets, drawers, shelves and ice cube tray on the position supplied by manufacturer.
- This refrigerating appliance is not intended to be used as a built-in appliance.

Install Instruction

For refrigerating appliances with climate class

Depending on the climate class, This refrigerating appliance is intended to be used at ambient temperatures range as specified following table.

The climate class can be found on the rating plate. The product may not operate properly at temperatures outside of the specific range.

You can find climate class on label inside of your refrigerator

Effective temperature range

The refrigerator is designed to operate normally in the temperature range specified by its class rating.

Class	Symbol	Ambient Temperature range (°C)	
		IEC 62552 (ISO 15502)	ISO 8561
Extended Temperate	SN	+10 to +32	+10 to +32
Temperate	N	+16 to +32	+16 to +32
Subtropical	ST	+16 to +38	+18 to +38
Tropical	T	+16 to +43	+18 to +43

NOTE

The cooling performance and power consumption of the refrigerator may be affected by the ambient temperature, the door-opening frequency, and the location of the refrigerator. We recommend adjusting the temperature settings as appropriate.

Temperature Instruction

Recommended Temperature

The optimal temperature setting for food storage:

- Freezer: -19 °C
- Fridge of Freezer: 3 °C

NOTE

The optimal temperature setting of each compartment depends on the ambient temperature. Above optimal temperature is based on the ambient temperature of 25 °C.

Power Freeze

Power Freeze speeds up the freezing process at maximum fan speed. The freezer keeps running at full speed for 50 hours and then returns to the previous temperature. To freeze large amounts of food, activate Power Freeze for at least 20 hours before putting food in the freezer.

NOTE

When you use this function the energy consumption of the refrigerator will increase. Remember to turn it off when you don't need it and return the freezer to your original temperature setting.

How to store for best preservation (applicable models only)

Cover foods to retain moisture and prevent them from picking up odors from other foods. A large pot of food like soup or stew should be divided into small portions and put in shallow containers before being refrigerated. A large cut of meat or whole poultry should be divided into smaller pieces or placed in shallow containers before refrigerating.

Appendix

Placement of Foods

Shelves	Shelves should be adjustable to accommodate a variety of packages.
Specialized compartment (applicable models only)	Sealed crisper drawers provide an optimal storage environment for fruits and vegetables. Vegetables require higher humidity conditions while fruits require lower humidity conditions. Crispers are equipped with controls devices to control the humidity level. (*Depending on model and options) An adjustable temperature meat drawer maximizes the storage time of meats and cheeses.
Stored on the door	Don't store perishable foods in the door. Eggs should be stored in the carton on a shelf. The temperature of the storage bins in the door fluctuate more than the temperature in the cabinet. Keep the door closed as much as possible.
Freezer Compartment	You can store frozen food, make ice cubes and freeze fresh food in the freezer compartment.

NOTE

Freeze fresh, undamaged food only. Keep food which is to be frozen away from food which is already frozen. To prevent food from losing its flavour or drying out, place in airtight containers.

Refrigerator & Freezer Storage Chart

The freshness longevity depends on temperature and exposure to moisture. Since product dates aren't a guide for safe use of a product, consult this chart and follow these tips.

Milk products

Product	Refrigerator	Freezer
Milk	1 week	1 month
Butter	2 weeks	12 months
Ice cream	-	2-3 weeks
Natural cheese	1 month	4-6 months
Cream cheese	2 weeks	Not recommended
Yogurt	1 month	-

Meat

Product	Refrigerator	Freezer
Fresh roasts, steaks, chops	3-4 days	2-3 months
Fresh ground meat, stew meat	1-2 days	3-4 months
Bacon	7 days	1 month
Sausage, Raw from pork, beef, turkey	1-2 days	1-2 months

Poultry / Eggs

Product	Refrigerator	Freezer
Fresh poultry	2 days	6-8 months
Poultry salad	1 day	-
Eggs, Fresh in shell	2-4 weeks	Not recommended

Fish / Seafood

Product	Refrigerator	Freezer
Fresh fish	1-2 days	3-6 months
Cooked fish	3-4 days	1 month
Fish salad	1 day	Not recommended
Dried or pickled fish	3-4 weeks	-

Fruits

Product	Refrigerator	Freezer
Apples	1 month	-
Peaches	2-3 weeks	-
Pineapple	1 week	-
Other fresh fruit	3-5 days	9-12 months

Appendix

Vegetables

Product	Refrigerator	Freezer
Asparagus	2-3 days	-
Broccoli, Brussels sprouts, green peas, mushrooms	3-5 days	-
Cabbage, cauliflower, celery, cucumbers, lettuce	1 week	-
Carrots, beets, radishes	2 weeks	-

Information for model and ordering spare parts

Model information

To access energy labelling information about this product on the European Product Registry for Energy Labelling (EPREL), scan QR-Code on the energy label.

You can find QR-Code on the energy label in your product box.

Part information

- The minimum period during which spare parts, necessary for the repair of the appliance, are available
 - 7 Years thermostats, temperature sensors, printed circuit boards and light sources, door handles, door hinges, trays, baskets (boxes or drawers)
 - 10 Years door gaskets
- The minimum duration of the guarantee of the refrigerating appliance offered by the manufacturer 24 Months.
- Relevant information for ordering spare parts, directly or through other channels provided by the manufacturer, importer or authorized representative
- You can find professional repair information on <http://samsung.com/support>. You can find user servicing manual on <http://samsung.com/support>.

Open Source Announcement

(applicable models only)

The software included in this product contains open source software.

The following URL http://opensource.samsung.com/opensource/SMART_TP1_0/seq/0 leads to open source license information as related to this product.



Declaration of conformity

NOTE

Hereby, Samsung declares that this radio equipment is in compliance with Directive 2014/53/EU and with the relevant statutory requirements in the UK.

The full text of the EU declaration of conformity and the UK declaration of conformity is available at the following internet address: The official Declaration of conformity may be found at <http://www.samsung.com>, go to Support > Search Product Support and enter the model name.



CAUTION

The 5 GHz WLAN function of this equipment may only be operated indoors. This equipment may be operated in all EU countries and in the UK. (Applicable models only)

	Frequency range	Transmitter power (Max)
Wi-Fi	2412 - 2472 MHz	20 dBm
	5120 - 5250 MHz	23 dBm
	5250 - 5350 MHz	20 dBm
	5470 - 5725 MHz	27 dBm
Bluetooth	2402 - 2480 MHz	20 dBm

Memo

Memo

Memo

FRANCE	01 48 63 00 00	http://www.samsung.com/support
GERMANY	06196 77 555 77	
LUXEMBURG	+352 2610 37 10	
NETHERLANDS	+31 88 909 0111	
BELGIUM	+32 26200210	
NORWAY	21 62 90 99	
DENMARK	70 70 19 70	
FINLAND	OLD 030-622 75 15, NEW number: 0800 528 475	
SWEDEN	0771-400 300	
CYPRUS	8009 4000 only from landline, toll free	
GREECE	80111-SAMSUNG (80111 726 7864) from mobile and land line (+30) 210 6897691 from mobile and land line	
ITALIA	800-SAMSUNG (800.7267864)	
PORTUGAL	210 608 098 Chamada para a rede fixa nacional Dias úteis das 9h às 20h	
SPAIN	91 175 00 15	

